

# FULCRUM

Copyright 1997

The Science Journal of  
The University of Science and Philosophy

**THE SCIENCE OF THE FUTURE IS BASED UPON GOD - THE CREATOR.  
GOD IS LIGHT - GOD IS MIND  
MIND IS ALONE OMNISCIENT AND OMNIPOTENT — LIGHT IS ALONE OMNIPRESENT**



THE UNDIVIDED WHITE LIGHT OF THE UNIVERSAL GOD-MIND



THE WHITE MIND-LIGHT DIVIDED INTO SPECTRUM PAIRS.

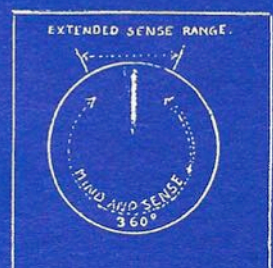
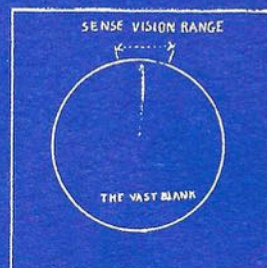

**GOD'S UNIVERSE OF "SPACE" IS AN INTENSELY LUMINOUS BLINDING WHITE LIGHT WHICH NO EYES CAN SEE. ILLUMINATES ALONE CAN SEE THAT LIGHT THROUGH THEIR CENTERS OF CONSCIOUSNESS LOCATED IN THEIR PINEAL GLANDS.**

**GOD'S WHITE MIND-LIGHT IS DARK TO MAN UNTIL HE DIVIDES IT INTO SPECTRUM PAIRS OF RED AND BLUE LIGHTS TO SCREEN THE WHITE LIGHT OF GOD'S MIND WHICH CENTERS EVERY CREATING THING.**

**MAN'S SENSES ARE TWO-WAY WAVES OF LIMITED FREQUENCIES. THEY DO NOT RESPOND TO VIBRATIONS BELOW OR ABOVE A VERY LIMITED RANGE.**

**MAN CAN EXTEND HIS RANGE OF SENSE VISION BY TELESCOPE OR MICROSCOPE, BUT HIS SENSES CANNOT GO BEYOND SPECTRUM EFFECT INTO MIND CAUSE.**

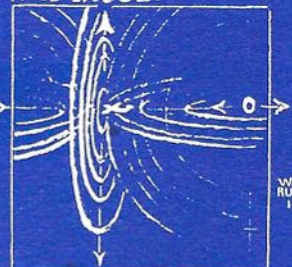
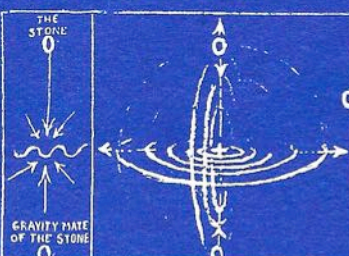
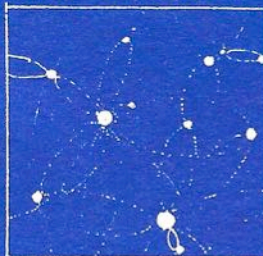

**MAN'S LIMITED SENSE VISION HAS CAUSED HIM TO SEE AN OBJECTIVE UNIVERSE OF MANY SEARATE DISUNITED THINGS. WHEN MIND-VISION UNFOLDS TO A HIGHER STAGE IN THE HUMAN RACE, BY INCREASING AWARENESS OF THE DIVINE LIGHT WHICH CENTERS MAN, HE WILL THEN SEE THAT EVERY THING IN THE UNIVERSE IS INSOLUBLY BOUND TO EVERY OTHER THING. SCIENCE WILL THEN KNOW THAT MATTER IS BUT MANY FOCAL POINTS OF ONE BODY.**

**WHEN A MAN MULTIPLIES GRAVITY BY CASTING A STONE IN THE WATER HIS SENSES SEE ONLY WAVE-RIPPLES. THEY DO NOT TELL HIM THAT THOSE RIPPLES ARE EQUATORIAL RING-SERIES OF EXPANDING SPHERES WHICH ARE DISSIPATING GRAVITY IN THE SAME RATIO AS IT IS BEING MULTIPLIED BY THE FALLING STONE. THE SAME PRINCIPLE APPLIES TO ALL ACTIONS. THIS IS, IN FACT, THIS IS THE VERY BASIS OF THE UNIVERSAL LIFE PRINCIPLE.**

**SCIENCE HAS BUILT A STRANGE UNIVERSE FROM SENSE EVIDENCE, AND HAS BEEN MIGHTILY DECEIVED.**

# FULCRUM

Volume 5, Number 2

November 1997

Fulcrum focuses on the science of creation as revealed to Walter Russell. Dr. Russell, artist/philosopher/illuminate, spent 35 years describing the Creator's multidimensional creation process to scientists and lay persons. Known as the Russell Cosmogony and published in several different written editions, the concepts revealed to Dr. Russell during his 39 day illumination in 1921 describe our multidimensional Universe as an extension of the One substance of God. More specifically all matter is described as Light. The Light of Thinking Mind spirally winds in centripetal vortex motion the One substance into the many forms we witness. Mind also unwinds through centrifugal vortex motion all manifest form into the formless zero from which it appeared.

The Russell Cosmogony can be found in its most mature form in *A New Concept Of The Universe, Atomic Suicide?*, *The Home Study Course*, and *The Secret Of Light*. His earlier descriptions can be found in *The Universal One* and *The Russell Genero - Radiative Concept*.

*Fulcrum* is now a tertiary and greatly expanded forum in which scholars and students can interact to exchange insights and perspectives on the interpretation and application of the principles of the Russell Cosmogony. *Fulcrum* is engaged in extending the understanding of the Russell Cosmogony as it applies to all of our civilization's institutions that this teaching might continue to grow and act as a mighty seed to assist the birth of a peaceful and sustainable culture.

As the editor I intend to publish articles by creative thinkers, artists and inventors that can help demonstrate the Russell's principles and make a difference in the direction of our world today- right now! Understanding the whole cycle vision of Universe as given by the Russell's and application of our understanding by students and scholars is essential for this work to complete its mission for the world. Without this demonstration humanity will continue on in its present beliefs in a Universe dying a heat death, where energy only runs downhill, where there is not enough life support let alone luxury or excess abundance to go around, where God is vengeful and thus so are we, where health is found in magic bullets, and everything is moving to greater and greater disorder- where entropy reigns supreme and unchallenged.

Our present science and technology, economic, social,

psychological, medical, philosophical, political and religious systems are patterned on entropic beliefs and foster entropic thinking and actions.

I will publish:

1) A dialogue with you on the Russell Cosmogony and literature. I invite questions from readers which may be published in each issue and answers given by you the readers or by me that will follow in the next issue. The responses may or may not be definitive. I intend to be clear, although clarity may take time to unfold. Our shared insights may or may not reach similar conclusions. My intent is that by sharing questions and answers, by sharing our perspectives and insights we will stimulate each others thinking and teach each other in the process. I invite you to participate. Have no fear, ask questions and give responses no matter what level of understanding and experience with this work you perceive yourself as having. We all come from, have access to and have our present being in the same source, the same source and being that the Russell's had.

2) Research and articles relevant to the Russell Cosmogony or that have meaning for humanity's need at this moment. What are your insights from this work? Do you know of other scientists, illuminates, or common people that have published works that have meaning for our common needs now? How do you see our institutions (science, art, religion, commerce, agriculture, education, medicine, and our human relations) from your understanding of the Russell work? I am eager to review your treatments and demonstrations of the Russell concepts for possible publication.

3) Articles on current or past experiments in the field of science and technology especially as it relates to non-polluting sustainable energy production and transportation, agriculture, medicine, economics, education, art, parapsychology, psychology, religion and metaphysics.

4) Articles on any application of the Russell work that might make a positive difference in humanity's future.

5) Patent papers on free energy inventions and articles about them.

I am pleased to present this issue of *Fulcrum* to you and look forward to your input and feedback.

Dr. Timothy A Binder, Editor

# Table of Contents

## Dialogue

Questions for the next issue .....	pg. 1
Responses to previous questions.....	pg. 1

Some of the featured articles for the next issue.....	pg. 1
---	-------

Letter to the editor.....	pg. 41
---------------------------	--------

## Featured articles

Mechanism of Low Temperature Transmutation by G Rabzi of the Ukrainian International Academy of Original Ideas.....	pg. 43
--	--------

The Web of Life from Soil to Humanity and the Role of Ancient Mineral Deposits in Agriculture, Animal and Human Nutrition and Medicine by Timothy A Binder.....	pg. 53
---	--------

Luminon- Does Increased Lamp Efficiency Utilize an Element Predicted by Walter Russell? by Toby Grotz.....	pg. 61
---	--------

Preliminary Results of Electron Microscopy and Electron Diffraction Spectroscopy of Carbon - Carbon ARC Experiments by Toby Grotz and Don Rapp .....	pg. 67
--	--------

## From The Archives

Letter from Dr. Russell to his friend and alternative physician Dr. Howard Lavendar regarding opinion about the medical practices of his time and the importance of nutrition and health .....	pg. 69
--	--------

Letter of proposal for multiplying power by the Russell Cosmogony .....	pg. 71
---	--------

Patent Paper - Powering electrical devices with energy abstracted from the atmosphere .....	pg. 74
---	--------

Some of our current state (+&-) almost half a century after publication of The World crisis, Atomic Suicide?, etc .....	pg. 77
--	--------

Newsletters/Periodicals .....	pg. 82
-------------------------------	--------

## Dialogue: Questions for the Next Issue

### Questions:

- 1) What were the original EM equations of James Clerk Maxwell? Is there a missing element in the equations as taught today? Is this missing element called quaternions, and might that give the scalar component that could show the relationship between gravity and EM phenomena? How would the Russell Cosmogony interpret this?
- 2) What did Walter Russell mean when he said that during his illumination he realized “the sensed electric wave universe had no reality whatsoever”? How do you live with what this means to you or how does it affect your life?
- 3) What are some references for investigating the ancient science of prophecy as per James Affleck’s request this issue’s letters to the editor?

## Some of the Featured Articles for the Next Issue

*The Great Pyramid, Octave 12 Tone Chromatic Scale, Sinusoidal Standing Wave, and Squaring the Circle Examined in Light of the Russell Cosmogony with Implications for Energy Production* by David Levick and Timothy A Binder.

*Mechanism of Low Temperature Transmutation, Part Two* by G. Rabzi of the Ukrainian International Academy of Original Ideas.

*Explanations of Dimensional Equations Detailing that All Phenomena are the Same Phenomena; or a Unification of Heat, Gravity, Electricity, and Light with an Accompanying Geometry* by Timothy A Binder.

## Dialogue: Responses to Previous Questions

**Questions:** Millennium Twain’s letters in the last two issues prompted these questions:

1) He claims that light has an unlimited and variable speed and it is a function of frequency. Does this conflict with or agree with Russell’s Cosmogony ( or does it do both) or what did Russell have to say about it? Can we “prove” the contention and what did the early Michelson Morley experiments really prove? Or did they prove what we were told?

2) MT says he discovered the non-linear, continuous, wave (AKA inertial vortex) topology of light. This appears to be the same discovery that Walter Russell revealed, and others that MT implies discovered in vortex theories revealed, that apply to light (and I believe apply to all motion/things). If light is such a wave, is not light all phenomena just as Jesus and Walter Russell stated? If this is so then will the dimensional equations and geometry I am searching for and promising to deliver in the next issue be able to demonstrate this contention?

3) What might MT mean as stated in his letter last issue that light’s unlimited and variable speed is a function of frequency?

4) In MT’s letter to Dale Ponds he says, “your longitudinal scalar wave is what some would call a gravity wave”. What are the standard definitions for a scalar wave and do these also define a gravity wave and what might Russell’s cosmology, or any of us as students of the work, be able to say about defining a scalar or a gravity wave? Can we engineer it to demonstrate it and use it in technology?

Two individuals have responded to this issues questions, my old reliable Larry Tieg and Millennium Twain. I am grateful for Larry being a regular respondent to most all of the ongoing *Fulcrum* dialogue and more recently for Millennium’s responses.. Such responses spark my responses and allow me to look at the questions in ways other than my own. Thank you Larry and Millennium!! My answers follow Larry’s and Millenium’s.

from Larry Tiegs

PREFACE

In trying to understand Russell we students face an obstacle. It is a bit like the frog in a well listening to the great bird in the sky describing the ocean. All the frog can relate to is his little pond. He just can't grasp how anything could be so big he couldn't jump over it. The frog is limited by his senses and his experience. His mind can't grasp the bigger picture.

We humans are like the frog. We each live in our own little worlds. Our worlds may seem very large to us but they are very very small. Planet Earth is our well. It is extremely small like the point of a needle in the whole sky. Our senses tell us it is very big and real. Our senses tell us our world is all there is. Our senses deceive us.

Every couple thousand years (less than a second in cosmic time) a great bird in the sky comes to tell us about the ocean. Most of us will ignore or ridicule the bird. It sounds like crazy talk. Some may listen but don't feel a need to understand. They may ask, "What could be more important than my pond." A few others may listen and hear something that "tweaks" within them for they do wonder once in a while about their world and life. But it is a momentary curiosity and thoughts of the great bird are soon forgotten.

Some of us are intellectuals and may be interested in this concept of an ocean. We are sometimes open to new ideas. We like to relate, equate and evaluate. We trust our senses and our ability to reason. Our world of sensing and reason is the real world. We distrust what can't be proved or measured. In our mind the concept of "ocean" may soon get equated down to the size of our own pond or maybe a little bigger with an added this or that. We may then seek credit for naming our "new" concept.

A growing number among us are awakening souls. We know we live in a well. As spiritual truth seekers we desire the "more", the freedom to be and to do. To us the great bird is an inspiration.

And blessed be the so very few among us who say, "I want to fly, show me how." To us, the great bird is ourselves.

Walter Russell is a great bird. He came to tell us about the well we live in and the whole ocean of existence, the great Reality which only the eyes of the Spirit can see and know. In his words:

"I come to give that comprehension, to build a new universe, so that the eyes of the Spirit see rather than the eyes of the body. I say to man, to scientists, to mathematicians: You have been seeing with the eyes of the body. Your laws of gravitation, your theories of chemistry, metallurgy, of the construction of the atom, of the expanding universe in which you have condemned God to die by a disease called entropy - the expanding universe - from your observations your eyes have told you things that are not so. Come with me, and with the eyes of the Spirit let us see what the universe is really like, not what it is not like." (Pg. 2 In The Wave)

Science has also gotten into metaphysics with its Uncertainty Principle which states that if you take a "snap shot" of a moving car you can know its exact location but not its speed. If you clock its speed, its definite location can't be known and its estimated location is dependent upon the observer. The observer is part of the proof.

Science has always held that mind is a function of matter. Religion would say matter is a function of mind. Could it be science is getting closer to Russell's statement of the need to unify science and religion, a true unity theory?

Comments on Dr. Tim's answers in the last Fulcrum, Vol 5 No. 1, all relating to a search for a Grand Unification Theory, popularly known as "GUTS."

Page 11, paragraph 1, answer to Question #1

In regards to a grand unification theory relating all phenomena, Dr. Tim states, "I believe that Russell implied this in his work but did not give us such an equation."

Russell's cosmogony - 42 years of writing and drawings explaining his knowingness from his many cosmic conscious experiences - is nothing but a complete and consistent grand unity theory of Creator, Creation and the cosmic process in all of Nature from microscopic mass to colossal mass. No, he didn't give us a simple mathematical formula to satisfy dual thinking, one-way minded scientists. If he had it wouldn't have been true. Equations only relate to what can be measured which is only one half Nature's cycle. The other invisible half can only be known. To see and equate only half the pieces of a puzzle will never give you the complete picture of the whole. Russell gives us the opportunity to see the whole. Better yet, he encourages us to "be the whole." "SEE HIM. KNOW HIM. BE HIM. Be Thou the Fulcrum of Thine Own Power." (Divine Iliad)

Page 11, paragraph 3, comments on questions 2,3 & 4

Dr. Tim states, " $G=m(v^2)$  unifies all phenomena as it expresses something that applies to all phenomena."

In the same sense so does  $E=mc^2$ ,  $P$  for pressure= $m(v^2)$  or  $D$  for density =  $m(v^2)$ . Newton's formula for small mass being attracted to big mass expresses something that applies to all phenomena also. But any true equation for unity must express our two-way continuous and changing universe, where "every action is voided as it occurs, is repeated as it is voided and recorded as it is repeated." In essence, nothing happens. It just seems to. Nothing is. That brings us to the only unity equation possible: zero + zero = zero.

Any unification theory must also describe the world we sense and the invisible world we can only know with our minds as a holographic cinema, ourselves the actors, the whole scene and all the actors as only a flicker in the Creator's imagination.

Of course today's scientists will laugh at such a preposterous concept. They ignored Russell in his day also, for they believed their bodies to be themselves, the world they sensed to be reality and all things as separate living and dying entities totally unconnected to each other or the universe. At their "death" they'll

thrown into a still lake creates encircling and expanding waves, it seems Einstein's newly conceived accelerating and curved space/time universe has gravity waves emitting from the presence of suns and planets on the fabric of space.

Gravity waves are a theory only. According to a recent T.V. scientific documentary about gravity wave measuring instruments located around the planet, they have yet to detect or measure a gravity wave.

What would Russell say?

There can be no such thing as a gravity wave emitting or radiating. Gravity, by his definition, is a centripetal vortex which compresses/implodes from the outside toward the inside, focusing like a tornado through the North and South poles of all spheres to a point at their centers - called the center of gravity. This generating, compressive and gravitating vortex, a whirlpool, winds up space gases into solid spheres and keeps all heavenly bodies rotating.

The polar opposite of gravity is radiation. Radiating waves do emit, expand and dissipate toward space. The expanding water ripples around the rock in the lake are radiating waves. So are heat waves rising off a hot road, waning sound waves and smoke rising from a fire. Radiating waves are centrifugal which start at a point and expand from the inside outward, compressing at the circumference to fill all space, like air radiating into a tire from the compression stroke of the tire pump. A radiating wave can not be called a gravity wave. A gravity wave would not, could not give off radiating waves.

Suns and planets do radiate at their equators. That's how suns give birth to planets and planets to moons. As suns and planets age toward maturity (perfect spheres), they get bigger and less dense, giving off gases at their equators. Examples are the sun's solar flares, the visible belts of Jupiter and the rings of Saturn which will eventually wind up and compress into moons. All planets themselves were once rings around the sun before winding up into hot and dense spheres, revolving steadily away from the sun to cool in space.

Russell's cosmogony is quite unlike contemporary beliefs in the Big Bang, the fusion of large asteroids at high speed to create planets and the pummeling of planets by more asteroids which created their intense inner heat. Bear in mind that all this took place in an instant, so that now, after perhaps millions of generations of suns and their families, all of our current billions upon billions of heavenly bodies received just the right "initial impulse" from the Big Bang to maintain their present perfect orbits and rotations. Makes one smile, doesn't it? Well, this theory is better than the one with our flat earth being supported on the backs of four elephants and later, after being conceived as a sphere, of being pushed around by angels. Or is it?

To be fair, physics is progressing toward the truth of a holistic, ever creating two-way universe with their current theories of anti-matter, dark matter and virtual particles. Black holes which they can't detect because they emit no light are incorrectly seen as gravity vortexes rather than the vacuous womb that gave birth to solar bodies, but the concept of a black hole is there.

And then there is the question of how a UFO could travel from the Pleiades to Billy Meier's mountain top in Switzerland in nine earth hours? Makes one wonder what fast is, doesn't it?

### Question #2

Part (A) If light is such a wave (the word "such" referring to various descriptions of various vortex theories),

Part (B) is not light all phenomena just as Jesus and Walter Russell stated? (underlining added)

(A) Russell is the only writer I'm aware of who comprehensively describes and illustrates the two-way living/dying, centripetal/centrifugal vortex motion within an eight tone step-up/step-down octave wave field centered with zero. I have no idea what these other writers are talking about so can't compare "such" a wave with Russell's.

(B) No, light is not all phenomena. Jesus said, "God is Light" (capital "L"). Russell states over and over again in the Secret of Light (capital "L") that Light is Cause of all that is. Effects, phenomena - the illusion of the seeming many - are motion only, which give off light or visibility. Motion also creates temperature, density and pulse. Therefore light is not all phenomena but simply one visible and measurable aspect.

More accurately stated, "For I Am (Light) within all things (phenomena) centering them and without all things controlling them." (Divine Iliad, words in parentheses added)

Part (C) Will Dr. Tim be able to demonstrate his thesis relating light and all phenomena?

Sure. You can also relate energy, heat, electricity and polarity to all phenomena. Will it prove to be the long sought after grand unification theory? Nope, because in the ultimate Reality there is only perception. The perceiver and the perceived are conceptual only. Awareness alone is. We live in a thought-wave mind only universe. All else is imagination. Russell tells us this over and over again. So how can you unite what was never divided but only seems to be?

### Question #3 What did 'MT mean ...?

I have no idea. With all due respect for he is a thinker, I find no interest or time to waste trying to understand Mr. MT. Why drink of muddy water when a clear fresh spring is at hand? Russell's point of view and my analysis to the rest of this question are stated in question #1.

### Question #4 What are the standard definitions for a scalar wave?

I have no idea and I've read and listened to Bearden off and on for several years.

Part (B) Does a scalar wave define a gravity wave?

I have no idea.

Einstein's 1915 General Theory of Relativity, based on Newton's inaccurate theory that mass creates gravity, predicts that suns and planets will cause emission of gravitational waves, ripples in the curvature of space that travel at the speed of light. Like a rock



That the speed of light is constant underscores the accuracy of all established wave lengths and frequencies of the whole electromagnetic spectrum (Russell would call it the electrically conditioned light wave spectrum). Elemental identification by spectrum analysis would be impossible without a fixed speed of light.

The "electromagnetic" spectrum is a chart of all known wave frequencies/wave lengths. Radio waves are up to several miles long and as slow as 31,000 vibrations per second (hertz). On the other end of the spectrum are gamma rays which are trillionths of a centimeter in length and  $10^{22}$  (22 zeros) vibrations per second. White visible light is a narrow sliver somewhere in the middle between ultra violet rays on the blue side and infrared on the red side with wave lengths of .000015 to .000296 inches and frequencies of 700 and 400 trillion per second.

Part (C) What did Michelson and Morley prove?

In 1887 they demonstrated that the speed of light was constant regardless of the speed of the observer. They expected to find the speed of light faster when measured parallel to the Earth's rotation because of the speed of the Earth's motion itself. It wasn't any different than when measured at 90 degrees to the Earth's rotation. The speed of light was constant regardless of the observers speed.

This surprised Einstein also, but he accepted it and incorporated it into his 1905 ( $E=mc^2$ ) Specific Theory of Relativity. Here he envisions an unaccelerating geodesic flat space/time universe where all velocities are relative except light.

While the constant speed of light-waves/thought-waves fulfills science's theories, numerical relationships and empirical methods for reproducible proofs, the essence of science is to question. Therefore, is the speed of light the fastest "thing" in the universe? I don't think so.

As Anna, a seven year old in the true story Mister God, This Is Anna, explains to Fynn, the shadow of our Earth on some distant galaxy "squillions" of miles away could travel "squillions" of miles a second. Just as a penny held to our eye can block out the light of a million mile diameter sun, so the shadow of a distant planet could conceivable flash across the width of our entire galaxy - 100,000 light years - in a second. Of course this is theoretical, but isn't most of current physics?

Even faster is the instantaneous Knowing of Omnipresent Mind. God's Omniscient and Omnipotent Mind is all knowing everywhere present. Knowing is cosmically instantaneous. This is easy to grasp if we think of the entire cosmos as one body, all seemingly separate parts connected by invisible threads of White Light. That's why Russell states the universe maintains absolute perfect balance even down to the weight of a milligram. Mind is Light. Thinking creates waves of motion, light-waves/thought-waves. Mind thinking divides invisible Light into visible light-waves which wind up into faster and faster motion which seem to be solid. The "solids" are simultaneously balanced by black holes in vacuous space from which they were wound. Eventually the fast motion unwinds by slowing down, becoming still in the zero invisible Light of its beginning. This is Nature's evolution and devolution process which takes time. But the Idea in Creators Mind was/is cosmically instantaneous everywhere.

"Man's limited sense vision has caused him to see an objective universe of many separate disunited things. When mind-vision unfolds to a higher state in the human race, by increasing awareness of the Divine Light which centers man, he will then see that every thing in the universe is insolubly bound to every other thing. Science will then know that matter is but many focal points of one body.

"Science has built a strange universe from sense evidence, and has been mightily deceived.

"God's universe of "space" is an intensely luminous blinding White Light which no eyes can see. Illuminates alone can see that Light through their centers of consciousness located in their pineal glands." (pg. 62, In The Wave)

#### Question #1

Part (A) Is the speed of light fixed or variable?

First, let us be clear. This question presupposes the word light means light-in-motion or incandescence, the visible light we sense with our eyes, split with a prism and measure with our spectrometers. The question does not refer to Light-in-rest, the undivided White Light of the Universal God Mind. This White Light is seen as the blackness of space because it is invisible to our eyes. Only the inner mind vision of spiritual illuminates can see it as white. "God's White Mind-Light is dark to man until he divides it into spectrum pairs of red and blue lights to screen the White Light of God's Mind which centers every creating thing." (pg. 62, In The Wave)

This White Light Mind stuff is omnipresent, the only cosmic substance there is. It winds up into fast orbital motion, incandescent suns, earths, elements and all forming things. But all things - matter - is nothing but fast motion of divided White Light, centered by White Light.

Now, Russell says and implies throughout all his writings that light is fixed at the specified speed of 186,000 miles or 300,000 kilometers a second. This means light can "travel" around our planet about  $7\frac{1}{2}$  times a second. That the velocity of light is constant through a given medium regardless of frequency is about the only premise of conventional science Russell accepts wholly as fact.

A variable speed of light would be like changing the length of a ruler, of having a variable meter length rather than one fixed at 100 centimeters. Science's Uncertainty Principle and Chaos Theory would certainly become totally valid.

Russell reasons throughout his books that the whole universe is nothing but a projection of Mind-Idea into a three dimensional world of thought-wave timed sequences. Since all waves of motion are thought-waves of the Universal Thinker projected from the omnipresent zero Light-of-rest, thought-waves and light-waves are one and the same. "Time cycles for reproduction of electric thought-waves is constant." (NCU pg. 84)

Part (B) Is the speed of light a function of frequency?

No. The formula is: Speed of light = frequency x wave length. Dividing wave length into the speed of light gives you the frequency. Dividing frequency into the speed of light gives you wave length.

experience their moment of truth, when in a pure Love state they'll know their continuing awareness as themselves as they look down upon their dead body. Until then they'll create formulas to prove ....

I do encourage the thought process involved in developing a "Guts." If anyone has one, be sure and sent it to Stephen Hawking. He can add it to the two or three he says he receives each week.

Page 11, paragraph 6

Dr. Tim questions, "is the One real or is the Many real? Russell at least implied that they both are real while he emphasized the "spiritual" universe or the "One" as being reality."

Sorry! but Russell's knowing consciousness could never nor ever did imply the many (effects, phenomena -motion only) as real (Cause). It would have been a total contradiction. He always referred to what we call the world as "motion only, there being no reality in motion." He called it a "seeming reality," or "simulation of reality" or "extension of idea into seeming thought forms" or "the unfolding refolding of patterns." He was always absolutely clear in thought and presentation on this point, choosing his words carefully to avoid trapping us in our "I am real, this is real" body sensing mentality. He states, " I also instantly knew ... that the sensed electric wave universe of motion ... had no reality whatsoever." (Home study course, the story of his illumination)

Page 12, paragraph 8

Dr. Tim states, "As all things have dimensions and all dimensions thus also have measure and a geometric structure there can be dimensional equations and geometric expressions for all of them. Color is expressed in wavelengths ...."

Yes, in the sense all things are vibrations within octave wave fields of two-way motion. The color spectrum, music and all the elements are created within octave wave fields. To understand the octave ratios of music, for example, may help to better understand the pressure ratios needed to produce an octave of elements. Better yet is to understand the "field," for it is the field that creates the reactive centripetal implosion that winds gases into solids and guitar strings into sound. It is the wave field that produces resonance or rhythmic balanced interchange, the key to the creation of our two-way seeming universe.

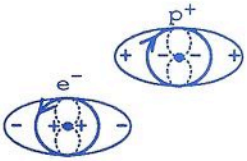

# Plasmatronix Intl, Post Office Box E

Menlo Park CA 94026 USA, tele 415-569-3299

<http://www.mediacity.com/~muse>

Tim Binder,

12 July 1997

Indeed, entropy does "reign supreme and [largely] unchallenged" in North America, and throughout 'civilization' whether 'Western' or 'Eastern', northern-hemispherical or southern-hemispherical.

Disorder and destruction, as opposed to creativity and harmony, **are** the rule -- as Viktor Schauberger's life, work and philosophy strongly punctuated.

I am glad to see all the discussion/interaction in V5N1, and the article from Ron Kovac. With this letter, I will attempt to participate in your ongoing question and answer process -- specifically addressing any thoughts from that issue which caught my evanescent (opaque?) interest.

The helical **enertia**-wave moving laterally and longitudinally away from source.

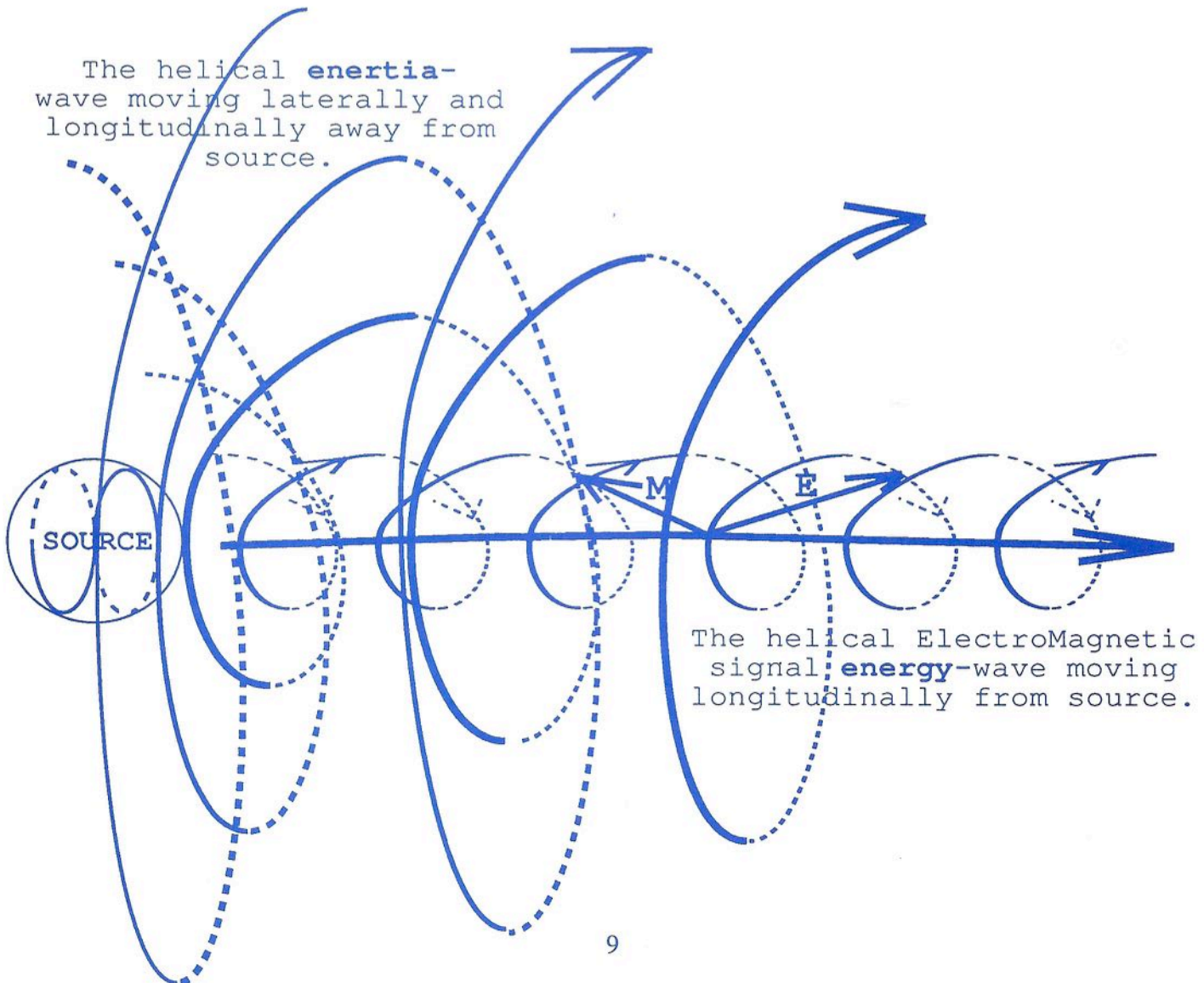

The helical ElectroMagnetic signal, **energy**-wave moving longitudinally from source.

I have attached a concurrent email letter to Miodrag Malovic in Yugoslavia relevant to the discussion of the structure of light, or **the electromagnetic wave, which I equate with aether or enertia** -- the dynamic helicoidal vortex of all experience (spin, propagation, compression and expansion) aka nature.

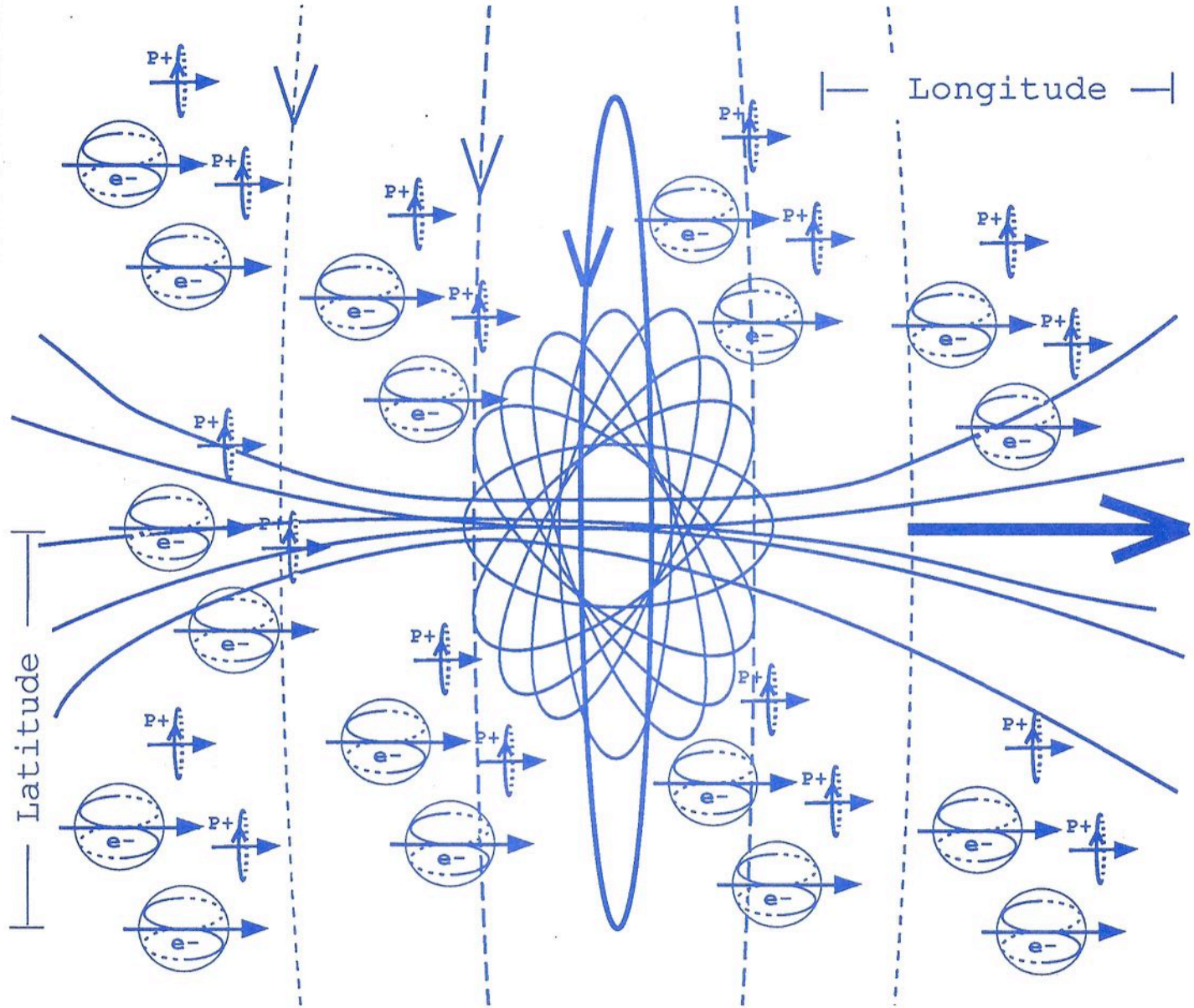

Gravity, clearly, is a word that is so ambiguous as to be without meaning in the present day. [Ditto 'antigravity'.] Our terrestrial surface 'gravitational' experience is not the same as:

- 1) centrifugal acceleration,
- 2) linear acceleration,
- 3) our underwater experience of 'gravity',
- 4) our experiences with aircraft,
- 5) and other accelerated, or pressure experiences.

For example, aircraft sometimes fall up (updraft). People (alive) float on the water, or **rise** to the surface when underwater.

I must agree that all matter is made from light, or **aenertia** as I am naming the fundamental substrate of experience. Light or aenertia (as the words are used by me) should not be confused with the undefined concepts of matter or energy however. Positive (and even negative) matter and energy are only limited and quantized subsets of the **several times larger cosmic-sea of aenertia**.

One of the central questions to me -- and my area of greatest ambiguity and study -- is this of the relationships of these differing (intepretational?) light components: electricity, magnetism, and gravity/acceleration.

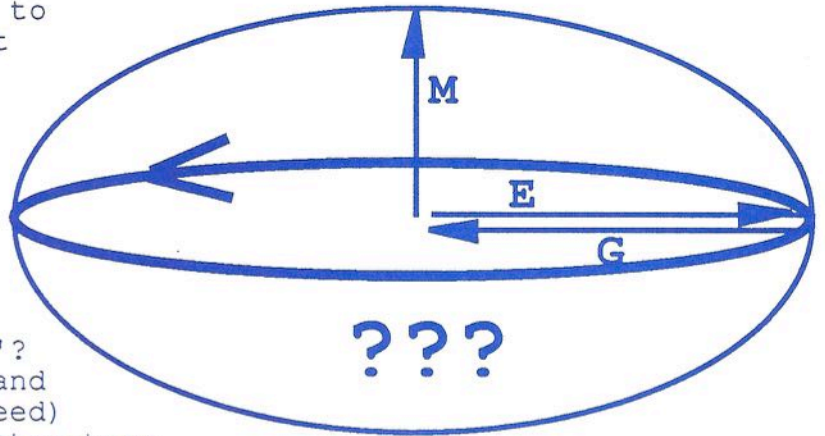

What is meant by 'scalar'?  
 By lateral and 'longitudinal'?  
 How do the concepts of spin and propagation (rotation and speed) relate to the true nature & structure of light, or enertia/aenertia?

Three to five years ago I was toying with the above visualization of the relationship of electric compression/rarefaction, to magnetic torsion, to gravitic acceleration -- limited by Pharis William's mathematical conception of 'Space, Time and Mass', and especially my own small (unharmonius) mind. More recently, I threw out the concept of gravity (like energy) as undefined, meaningless, ambiguous, and **just another word for acceleration**. Thus I asserted that there is no need for a principle of equivalence (between the general concept of acceleration, and the specific surface-gravity experience by humans on Earth.) i.e., I (over-)simplified the terminology and said gravity equals acceleration equals longitudinal pressure. The lateral field I equate with electric charge separation, the local axial field with magnetic spin, the macro longitudinal pressure field with gravity. [But this simplifies gravity to simply linear acceleration or longitudinal pressure; not all pressures or accelerations.]

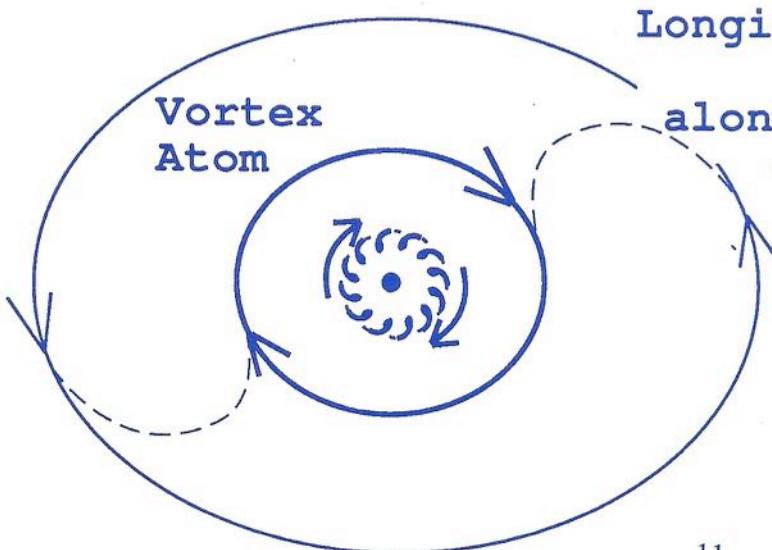

**Longitudinal Dimension --**

●  
 along the axis of spin,  
 out of the page

⋮  
**Lateral Dimensions --**

-----  
 up/down and left/right  
 in the page  
 ⋮

People, trees, and other 'standing' objects not only experience pressure or acceleration downward (and sometimes upward), they often accelerate **sideways** -- due to 'lateral' pressure waves (aka 'wind'). Add in our experiences (and those of clouds, tornadoes, hurricanes, and water drains) of the 'Coriolis' spin acceleration, clockwise in the northern hemisphere, counter-clockwise down-under.

Let's face it. Gravity is an undefined catch-all for a myriad of large group electromagnetic (aether) wave effects -- with lateral, spin **and** longitudinal components. [Clearly that is why the covert institution cannot do without it...] **Basically we are talking a whole lot of little aether particles** known as electrons, protons and atoms, and EM waves, added all together over their millions of billions of little teeny effects. The totality of these billions of millions of accelerations is a very large group pressure wave. [Try and illustrate that!] Longitudinal and lateral 'gravitational' experiences **are** different! A spacecraft at one AU from the Sun, in the ecliptic plane, **will** experience a different (qualitative and quantitative) acceleration at one AU over (above) the Sun's poles!

Half the planets, solar systems and galaxies in the cosmos are separating -- not falling together. Gravity never was, and never will be, an 'attractive' force. You and I, and even Jim Hodges and Chris Illert in Australia, are sucked and pushed to the surface of the Earth -- not due to attraction, but due to a myriad of little teeny electromagnetic forces, atmospheric pressures, and electrostatic and magnetic effects ('casimir' forces). [Note also: **the Earth is positively charged** with respect to our outer plasmasphere. The Sun is positively charged with respect to its heliosphere and the rest of our solar system. Ditto the galactic core, with respect to the outer Milky Way.]

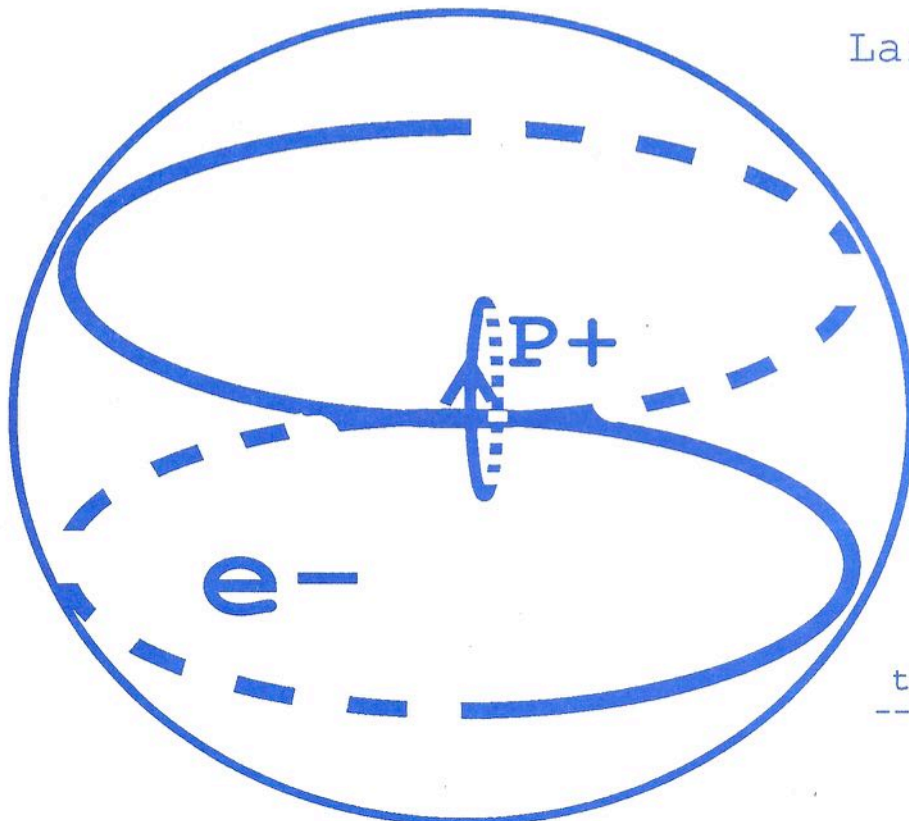

Large electron  
eats small  
proton!

You can see why,  
for simplicity,  
I like to begin and  
end all discussions  
with the structures of  
the electron and the proton  
-- or the New Hydrogen Atom!

Millennium

*Metric Relativity Proof*

*3 August 1994 Draft*

*MT*

## *The Undiscovered Physics*

by

**Millennium Twain**

© 1994

*That undiscovered country, from whose view  
No dreamer returns, puzzled still*

*And makes us rather flee the new  
Than knowing, act, in name of will*



# 4 Chapter 3: A Metric Relativity (Inertial Fields of Nature)

8/3/94 draft

## Physics Without Assumptions

This chapter is a proof of relationships, of the continuum of nature. Unlike the swarm of peer-reviewed linear 'theories' published in the 'physics' journals every month, this proof holds nature (not formalism) as both the means and ends of scientific research and technical achievement. Journals find sufficient justification in publishing a theory if the number of assumptions is infinite, and the number of predictions zero!

"First, we must  
learn to observe."

Contrariwise, my exploratory paper "Creating the Omniverse: A Primer on Field Geometry and Metric Relativity" sought to minimize the assumptions, and maximize the utility. It did away with the macroscopic concepts (energy, mass, charge, and momentum) which were undefined at the scale of the electron or proton, and eliminated the metric and geometric concepts which were equally meaningless (point, line, plane, cube, sphere, space, ether, universal distance, universal time).

In this work I will repeat and extend that success, and do it without introducing one single a priori assumption or axiom!

To do so I will begin with nature, and end with nature.

I will rename, reconceptualize and redefine the most basic and universal physical (inertial) experiences, to eliminate the ambiguous and often meaningless associations with the mythology of contemporary institutional physics. I will then explore the most basic physical topology or geometry of those experiences, and show the origin of metrics and the only descriptions of nature to which they may be applied.

This proof reveals the complete and rigorous structure, properties and interactions of all particle and wave-based experience -- upon which all of nature is constructed.

## A Metric Relativity

### A Metric Relativity

'Metric Relativity' is in some ways a misleading name for the fundamental metaphysical or qualitative preliminary understanding, conceptualization, definition, and analysis which must precede any discussion of physics.

What is described in this chapter is inertial field morphology or topology. 'Field' is used not in the sense of an abstract mathematical formalism, but in the physical or natural sense of a farmer's field, or a field of clover. [The continuous changing geometry of the furrows, clods, rocks and mud.]

That is just what the inertial fields of the cosmos are -- spinning and propagating regions of electric tension or rarefaction, magnetic moment or induction, and gravitic compression or contraction. Naming point-based matrices of abstract concepts 'fields,' is nonsense -- and so is the claim that such artifices describe nature!

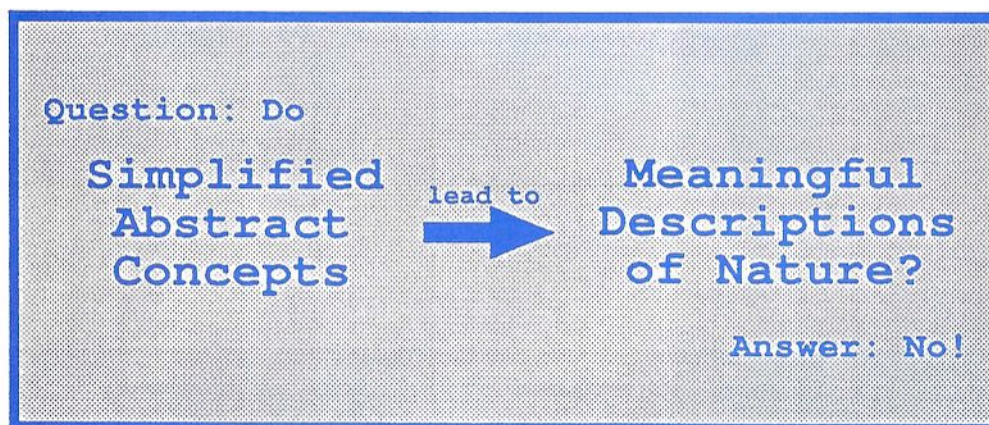

Indeed, all metrics (time and distance units) are artifices of limited utility. But when they are applied universally they lose all relationship to nature a.k.a. reality.

Metric Relativity is the qualitative mathematical analysis which identifies unique individual metrics with (and only with) unique individual particles and waves. It develops the description of the relationships (ratios) of the metrics between pairs of interacting particles and/or waves, and delimits the applicability of those new ratio metrics.

Clearly, concepts must follow nature. Nature is not dependent upon or derivative from humanity's simple-minded abstractions. To the extent that we recognize and respect the limits of conceptualizations, we may make use them in productive quantitative works.

Nature As Experienced By Humankind

The earth we walk on, the waters which support the life we know, the atmosphere we breath -- all are composed of two basic constituents or phenomena, charged particles and light.

A particle sea, named plasma, surrounds the earth in the ionosphere and plasmasphere, and girdles the planet in currents of electrons and protons.

Linking the electrons and protons to each other and all other matter are electromagnetic waves ranging from wavelengths of much less than  $10^{-15}$  cm up to the greatest scales of the cosmos. In their motion these waves follow the topological curvature popularly recognized as gravitation, and hence display the three known dimensional metrics of experience: up/down, in/out and forward/back. The changing or propagating phenomena of waves gives rise to the basic natural and human experience of then/now. Time.

Let me take these basic experiences of nature, no a-priori assumptions of mathematical abstractions, as the starting point for a complete description of all physics, all nature.

Thus will this proof be invulnerable to false assault, for it will begin and end with nature and will require no artifice. Further, it will be within the grasp of all peoples able to read it -- and therefore beyond the comprehension of all members of the covert institution of contemporary science!

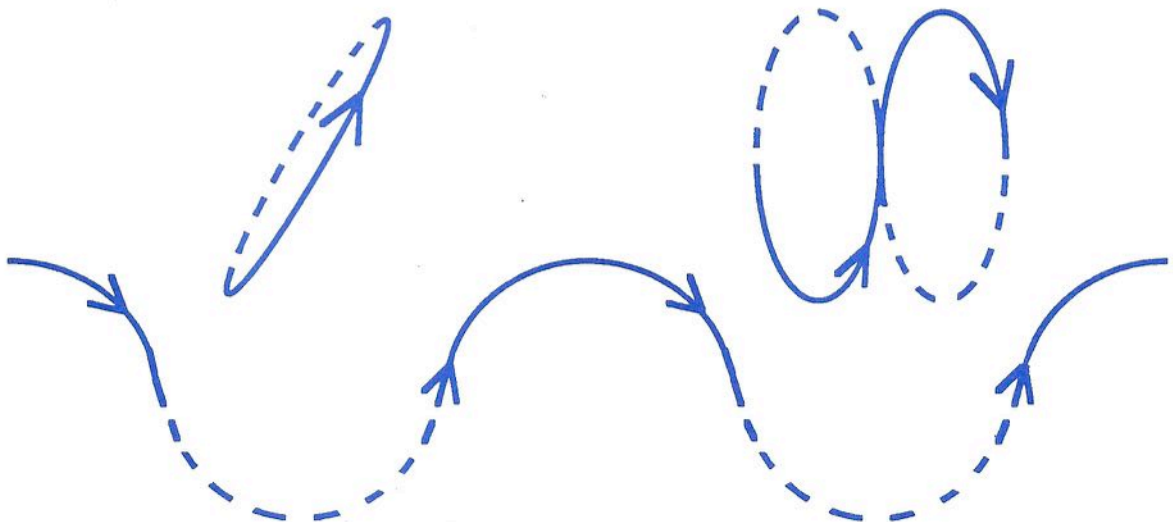

Light and Plasma are the foundation of all physical nature.

## Metric Relativity

### Inertial Wave Geometry of Experience

The entire world of engineering & science, and much of the arts, is intimately aware of the wide-ranging spectrum of electromagnetic 'radiation' (or light), and its characteristics of amplitude, frequency and velocity. The ubiquitous sinewave picture is common to physics, radio, electronics and music!

So too, the electron and the proton -- the stable charged particles from which are assembled all the atoms of the periodic table of the elements. Unlike the fanciful 'quarks' of the fables of government-paycheck particle physics, the role of charged particles in electronics, biology, chemistry, industry and the cosmos is well-known and unchallengable.

All elementary particulate forms and material bodies are the result of superpositions of waves. All. Everything in physics, in nature, in the cosmos. The reason that linear superposition fails for complex and particulate waveforms is that electromagnetic wave dynamics are not linear, and the theorists have neglected to take into account the obvious path geometry over which the waves propagate.

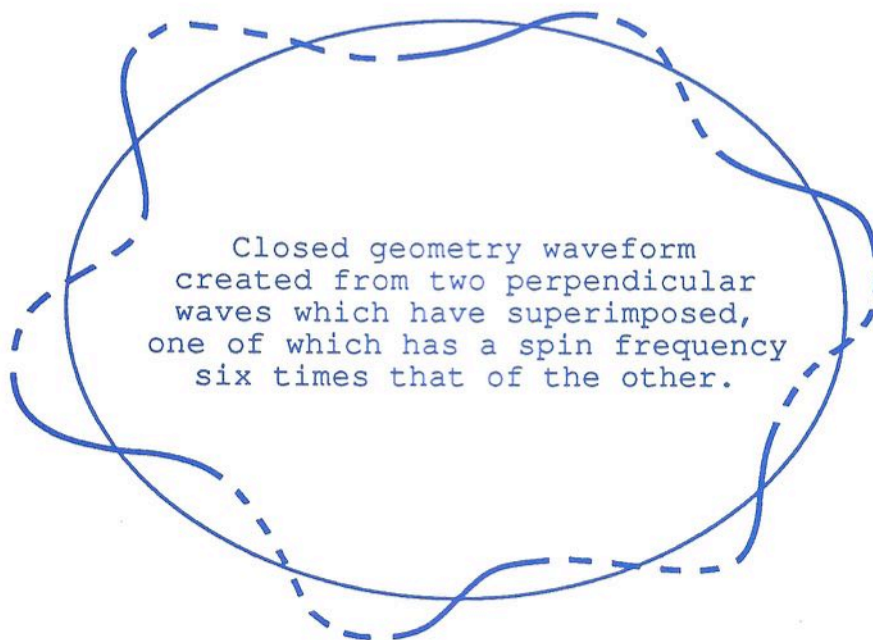

I name this nonlinear wave addition: complex superposition.

The path of propagation is a carrier wave to which the signal wave must be added. Only when the path is approximately linear, and the waveforms are simple transverse waves, does linear superposition provide approximately correct answers. Generally we must add in the curvature of the signal path, as well as the complex geometries of each wavepacket, particle and protoparticle (lightwave 'photon').

Origin and Identity

In contrast to "Creating the Omniverse" wherein I began the meta-physics by supposing a void, nothingness, then adding a metaphorical "pinch" -- here let me begin with a lightwave traversing the intergalactic cosmos, a known phenomenon in a (wishfully) known environment.

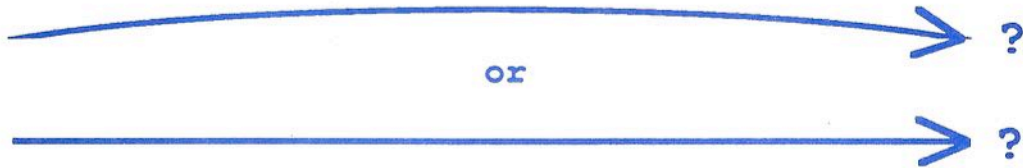

The electromagnetic wave traverses what conformists obligingly call the 'universe' on a geodetic propagation path generally approximated as a 'straight line.' The path geometry is in reality a section of a perimeter circle curving around the local 'centers of mass' of this 'matterverse,' as I name it.

[Another perspective: There are two kinds (and two kinds only) of motion, hence 'forces,' in nature: 1) attraction/repulsion ('linear'), and 2) rotational/spin (nonlinear).]

Our sample EM wave spirals around this perimeter curve, at the same time it propagates along it at approximately  $3 \times 10^9$  centimeters per second. Therefore, from the side, the high velocity spiraling motion looks like the familiar sinewave of physics, electronics and music. Thus we have two objects, entities, events, or references to compare with each other. When describing one, we utilize the other as 'observer' or the 'frame of reference:'

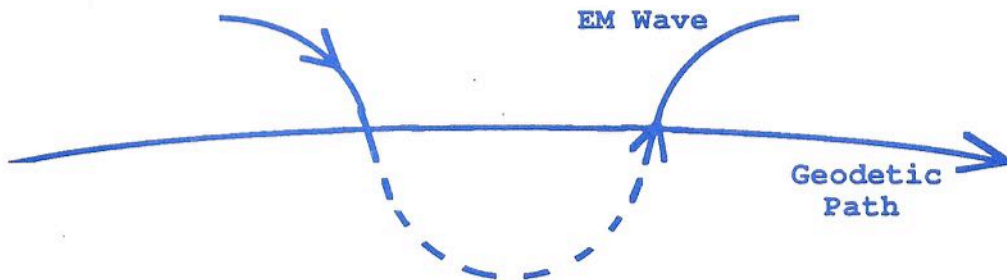

Note again: the reference path or observation frame is not a straight line. Straight lines, like mathematical points, create singularities or false 'infinities' which exist only in the minds of budget-drunk bureaucrats. They have no existence in nature, whether it be in an atom on the tip of your finger, or in the path of a gamma ray between galaxies.

## Metric Relativity

### Stepping Through the Motions

Simple Transverse Lightwave (No 'imaginary' 2nd freq)

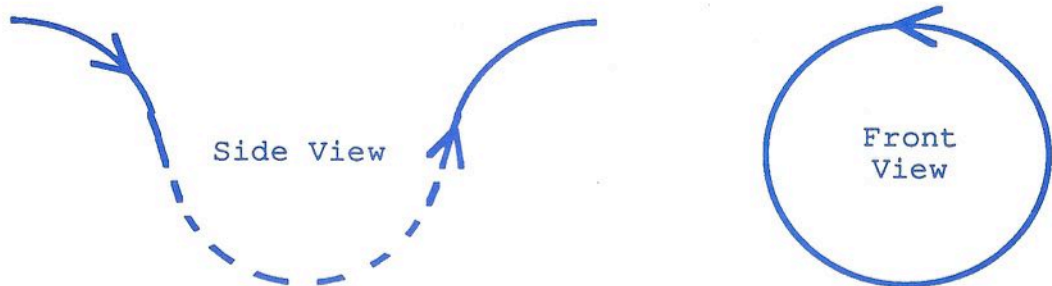

The above is a sideview of a pure electromagnetic wave, and a front view as if wave is coming towards you out of page. It spirals CCW, is propagating on an approximately linear geodetic path, and has no history of interaction to produce any 'imaginary' complex frequencies (undulations) in a perpendicular plane. It consists of one planar spin only, in addition to its 'linear' propagation motion.

Question: What happens to the motion topology due to the influence of the curvature of its geodetic path? The propagation path curve is equivalent to a very low frequency carrier wave, with the light being the superimposed signal.

Complex Transverse Lightwave (2nd frequency =  $90^\circ$ )



The electromagnetic lightwave acquires a 2nd planar spin frequency, an undulation, precession or wobble, causing the apparent frontview disk to oscillate back and forth at the 2nd frequency -- turning the sideview in-and-out of the page into a new dimension.

How can we describe this in terms of universal electromagnetic experience? Simple -- torqueing of the disk is an acceleration of its electric and magnetic vectors. Opposing (restoring) fields are generated, pushing the disk back in the reverse direction. A new 'AC' signal has been generated.

A second way to visualize this is as the perpendicular force transduction of a rotating gyroscope:

By attempting to push the top of the rotating EM disk, we induce a sideways twist response. Notice as the curvature acceleration continues with time, the magnitude of the 2nd planar frequency undulation grows:

Complex Transverse Lightwave (2nd frequency =  $170^\circ$ )



At the point visualized above, the 'imaginary' frequency has grown to be nearly one-half that of the initial primary frequency [One-half wavelength would be represented as  $180^\circ$ .] See how the new in-out twist of the lightwave has twisted it nearly completely out of the page. [The sideview sinewave is itself becoming an obvious helix.]

As the induced undulation exceeds  $180^\circ$ , the sinewave actually begins to curve around upon and behind itself:

Complex Transverse Lightwave (2nd frequency =  $190^\circ$ )

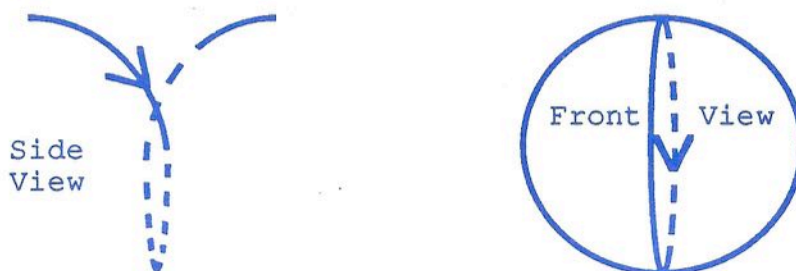

A third way to understand this is in terms of the longitudinal Amperé expansion/contraction discovery, praised by Maxwell, who then left it out of his equations of electromagnetism and electrodynamics. As a result, Einstein plunged ahead with his electromagnetism and electrodynamics (special and general relativity) without including a whole (unifying) description of the basic phenomena! Peter Graneau has re-discovered and popularized this nonlinearity.

## Metric Relativity

A 4th way to describe this I attribute to Jack H. Piddington's description of the way filamentary plasmas work in the Sun. Start with a propagating sequence of electrons, protons and ions in a strongly coupled mode known as a plasma filament. The waveguide envelope of this filament is simply an electromagnetic wave, a signal. It represents the spacing frequency of the filament's charged particles; or "plasma beads" in the Graneau description.

Complex Transverse Lightwave (2nd frequency =  $270^\circ$ )



When the filament is accelerated through curvature or by receipt of further electromagnetic radiation, the spiraling plasma particles speed up, thereby generating an increased axial magnetic induction field. [Their deBroglie wavelengths blueshift.] This axial induction field then, in a feedback relation, draws the spiraling particles in closer to the center of the filament -- acting as a pinch effect, that is, compressing elements of the filament sheath and core.

Lightwave Becomes Electron! (2nd frequency =  $360^\circ$ )

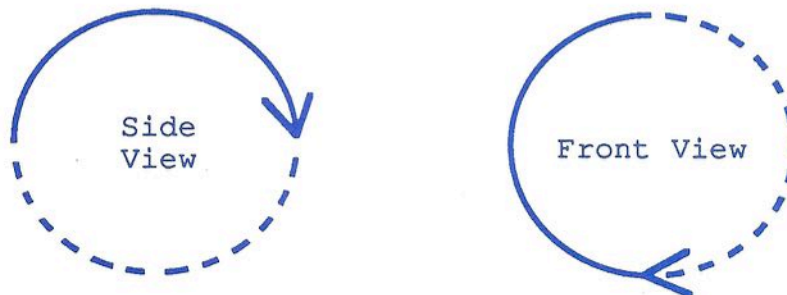

In the metric relativity inertial field model, until a lightwave becomes closed it simply represents the signal envelope of (or superposition with) the interacting plasma electrons. As it bends and becomes more complex, it acquires particle-like ('photon') properties of momentum. When the 2nd frequency ('imaginary') equals the original primary frequency ('real') -- closure due to electromagnetic reconnection occurs. It is now an electron.



## Simple Lightwave Becomes Complex, Becomes Electron

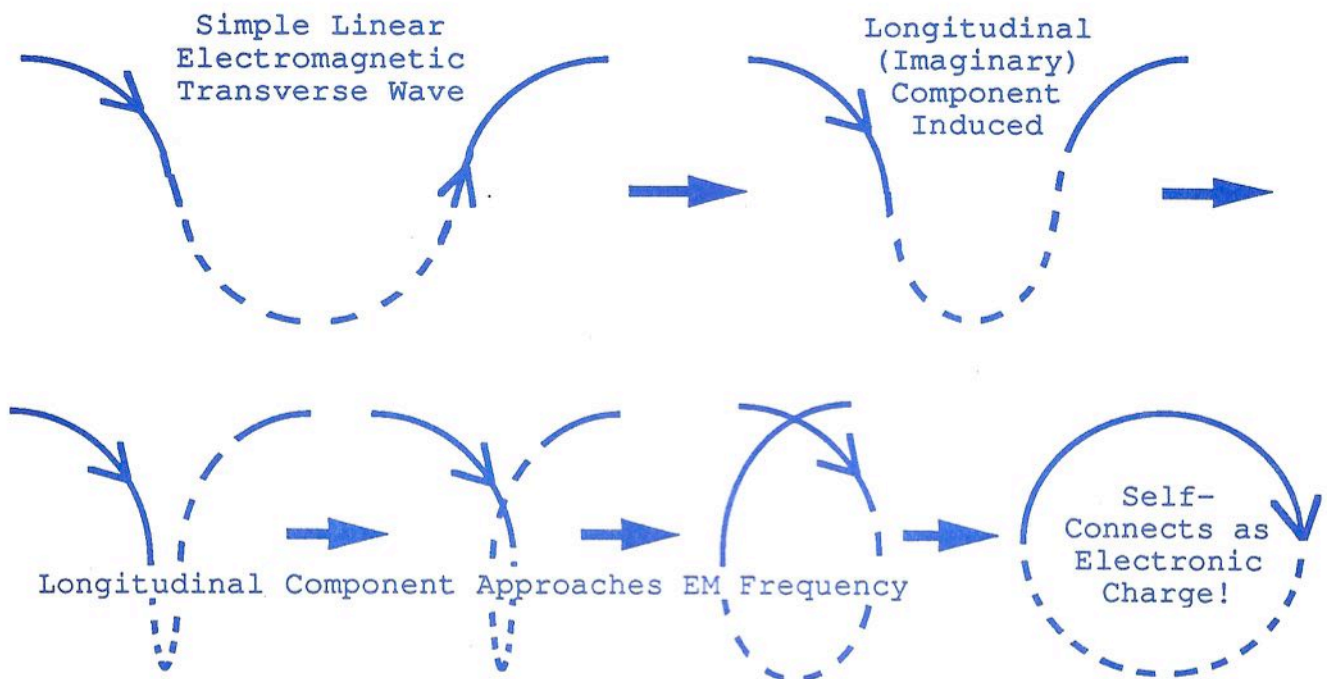

What the above step-by-step analysis demonstrates, as I stated earlier, is that there are two (and only two) types of motion -- and all dynamic geometrical experience in nature is the result of those two basic motions. The two motions are longitudinal (attraction / repulsion) and rotation (spin).

Linear motion simply describes the change of distance (attraction or repulsion) between two particles or objects. Measure the rotational spin for each electron, and 'time' is available to measure the rate of attraction/repulsion with respect to the ratio of their periods. Thus linear velocity.

Or determine the 2nd planar spin for one of the electrons, and you perceive an internal circulation velocity =  $C_e$  which is the ratio of the circumferential extent to the rotational period.

This internal balance (quantum condition) exists when the electric tension (amplitude potential) is exactly balanced by its gravitic compression (longitudinal curvature). That is, it expands outward at the same rate at which it contracts inward. The two gradients are in equal, but opposite directions.

The proton has a third internal frequency, yielding two internal levels of closure. One frequency is shared between each of the levels of closure. In the smallest, twist, level of closure the internal electric tension and gravitic compression are many times higher than that of the electron. Consequently the ratio of these two gradients,  $C_p$ , is a superluminal velocity.

## Metric Relativity

### Origin of Physics and Mathematics

As summarized in chapter 2, Proton and Neutron, I have identified the basic metrics and concepts of physics as derivative from the fundamental dynamic inertial fields of nature: electric tension, magnetic spin moment, and gravitic compression (or curvature). All these fields are embodied in the electron, creating our experience of 'space' or 'volume':

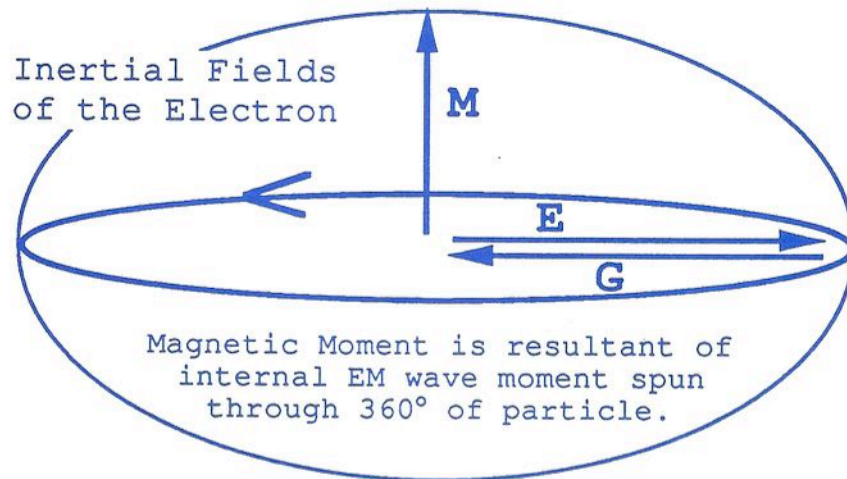

The derivative concepts and metrics are: radii (hence wavelength), period (times), frequency, circumferential velocity  $C$ ,  $\pi$ , and linear velocity.

All Dimension and Mathematics derives from  
EMG Lightwaves, the Electron and Proton

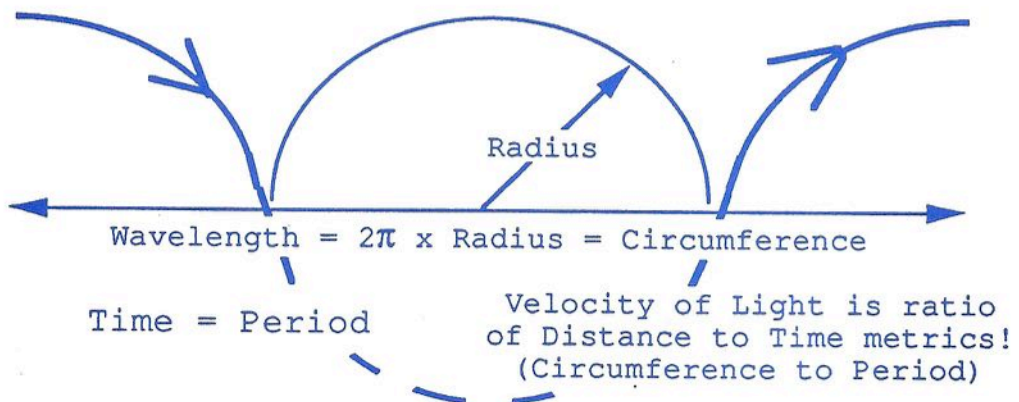

Addition and subtraction are not abstract concepts which can be accomplished simply through convention and artifice -- they are rigorously founded on the phenomenon of natural superposition in electromagnetism and electrodynamics! Multiplication and division also derive from nature -- being the process of comparing one wave or particle metric to another, producing concepts such as velocity and frequency.

$$\text{Velocity} = 2\pi \times \text{Radius} \times \text{Frequency}$$

$$V_{BE} \ll C, V_{FE} = C, V_N \gg C$$

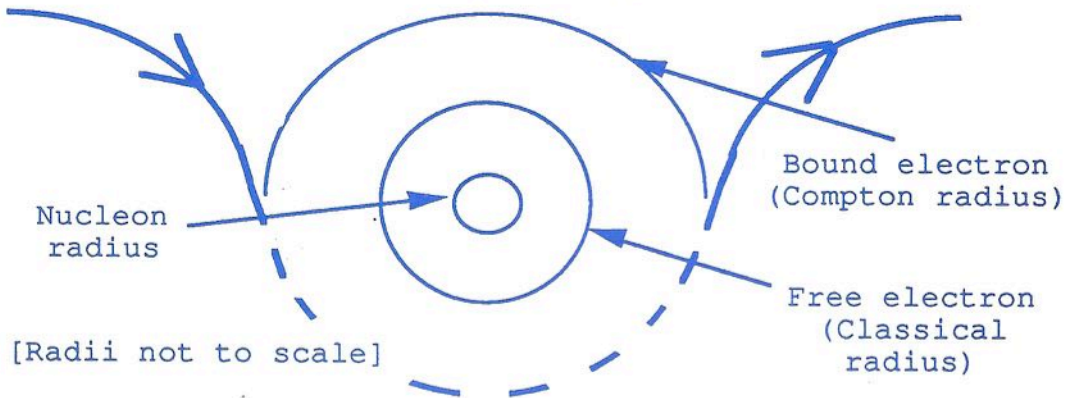

The origin of the velocity of light is the ratio of particle radius to spin period. That is,  $\text{Velocity} = \text{distance}/\text{time} = (2\pi \times \text{radius})/(\text{spin period})$ . Hence it can be used as a conversion factor between time and distance. EM waves propagate at the speed of light  $C$  because  $C$  is the circumferential spin velocity of electrons, the origin and carrier of EM fluctuations. If you were determining the 'size' of charges of matter by assuming a spin at the speed of light -- you would derive their circumference (hence radius) by assuming the frequency is directly proportional to the mass-energy. Your proton radius would be  $r_p = 1.53474 \times 10^{-16} \text{cm}$ . Too small by a factor of 200 to 400!

Why? Why is mass-energy not proportional to radius? Because  $\text{radius} = \text{velocity}/(2\pi f)$  -- and though you have derived a correct frequency for the proton spin, you have neglected the other variable, velocity!

The radius of the proton is 1/8th that of the free electron. Why so large? Because the proton achieves a higher energy-mass density the only way possible, by increasing the flux density of its E, M and G gradients. i.e., it must **spin** faster (curve 'spacetime' more) than an electron!

The reason that the proton has a radius much much larger than its mass-energy-frequency would predict, is that its spin velocity is much much larger than  $C$ . As a result the wavelength distance (circumference) covered in one frequency cycle is much much greater than it would be if it were simply moving at the speed of light.  $V = 2\pi r f$ , or velocity equals wavelength times frequency! No metric relationship is more fundamental.

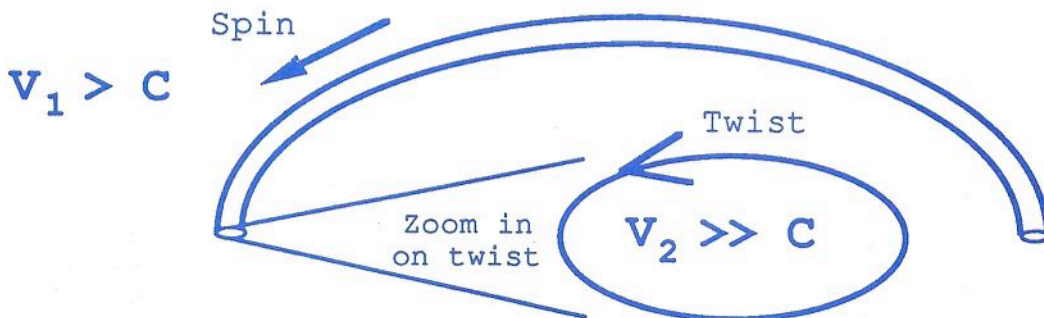

The proton wave helix has two internal velocities!

Inertia, Motion, and Geometry

The cosmos, as perceived and interpreted by the experience and mind of humankind, is a volumetric tossed sea of EMG waves and particles. The two-dimensional picture of these waves is a sine function (see previous illustration). The three-dimensional rendering is a helix (two perpendicular sine functions). Unlike meaningless zero-point-field (ZPF) mythologies which describe particles as points, and derive near-infinite energies across every  $10^{-33}$ cm of space -- the turbulent microstructure is simply the transient intercourse of open lightwave helices of all frequencies, and closed-helix particle plasma of all velocities.

We cannot dissociate the chicken from its egg, and hence can both discuss lightwaves as the geometrical consequence of plasma dynamics, as well as show the construction of plasma particles from their lightwave origins.

In any volume in experience, the displacement of one object results in the displacement of all adjacent objects, and so one without ending. When an electron expands or shrinks, or approaches or rebounds from an adjacent particle, that action precipitates an expanding helix (rotating spherical ellipsoid) wave emanation of reaction. [Visualize this as a big box full of eggs, with an empty balloon at the center. If you blow up the balloon, the eggs push away from the center. Similarly, if you were to break several of the eggs at the center, the other eggs would collapse inward, seeking to fill the gap.]

In the interplanetary, interstellar, or intergalactic medium of light and plasma this tendency to expand is interpreted as electric amplitude potential (here renamed electric tension), the tendency to induce spin (hence charge) is magnetic moment, and the tendency to consolidate is called gravity (gravitic compression). [To 'consolidate' is to match velocity and travel together]. Lightwaves expand away from the source of volume (geometry) change, sharing and distributing that change with all of the cosmos. This rotating expanding wavefront redshifts continuously, because its radius thus wavelength increases continuously. Associated with this wavefront are smaller signals (photons) of a more linear and particulate nature. These protoparticles are the 'straight' line scalar or compression wave impacts, and also the vector spin electromagnetic inertia conveyed to plasma particles 'receiving' and 'transmitting' the geometrical change.

All of these impacts, spins, expansions, compressions etc. are said to occur "at-a-distance". That is to say it has been known for over a century that no objects are discrete, or touch each other in any 'solid' sense. The surface of a solid, like the fluid of the sea or the force of the wind, is the result of electromagnetic spin interactions and velocity accelerations. Geometry is not a perfect sphere imagined in the mind, and a billiard ball is not a simple impenetrable surface. It is itself a sea of interacting ions, electrons and EM helix waves.

[The circles on this page represent particle quanta, helices are their lightwave interactions reflected back-and-forth].

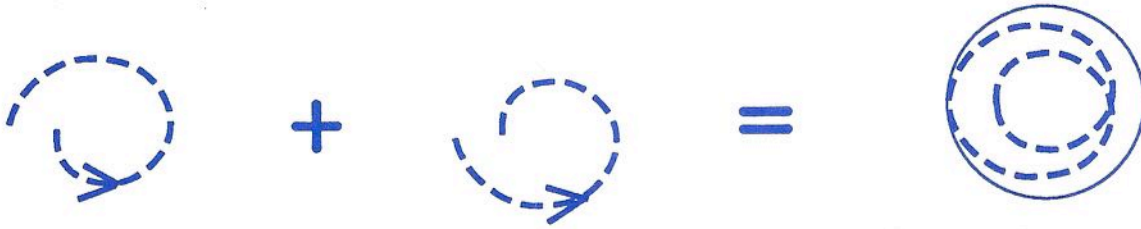

Expanding EM Wave Helix

Contracting EM Wave Helix

Charged Particle Self-Reflection (Closed Helix)

Charged particles are waves, maintained by internal wave pressure. They are not solid billiard balls. The 'feeling' of solidity is a consequence of the fact that you cannot push one lattice (your hand) through another lattice (the ball), without first decomposing one or both of the lattices into its separate particles. Even then, an ion from your hand may or may not pass through the ball lattice surface. It depends on velocity, orientation, frequency, phase and other characteristics (history) of the liberated ion.

[Using the term 'action-at-a-distance' leads to misinterpretation. "At a distance" from what? If every body and particle has extended fields of EM spin and gravitic propagation, and those fields occupy all regions of 'space' -- then the inertial waves are interacting everywhere in the intervening 'aether' between particles. 'Absolute space' is another, slightly better, term. The best picture is the superpositional light/plasma wave sea. Wave flux continuum!]

What does it mean for two or more objects to be connected, to touch? After all, atoms do not touch. Nucleons do not touch, electrons do not touch. The cells in our bodies do not touch. All are separated by EMG fields, superimposing & reflecting at all angles and phases.

Connectedness means -- associated geometrically (adjacent) in time or space! That is, they follow each other in time, on whatever trajectory, through whatever motions. The appearance of physical solidity means that we are observing an object with: 1) rotational frequency high compared to our observation frequency, or 2) linear velocity high with respect to us. i.e., we cannot match phase or velocity in order to get inside it. [Contrariwise, something that we can separate, can get inside of, is something of equal velocity or phase to us. We are connected to it. It's adjacent to, a part of, us. We are 'grouped' with it.]

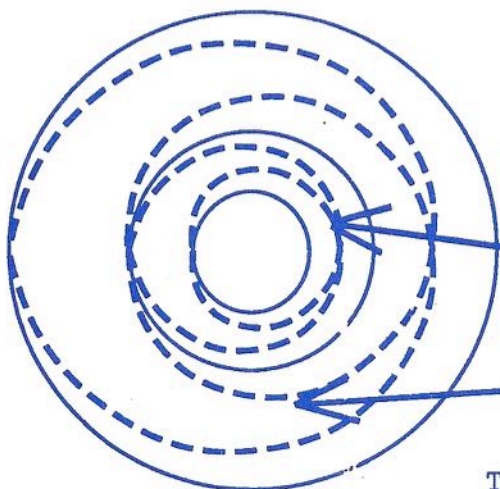

EMG Helix Atom

Atom's 'mesonic' environment between electrons and nucleus!

Lightwave 'absorption' or 'emission' environment between electron shells!

Thermal phonon helices fill the interatomic and intermolecular environments!

Electron Internal Wave Cycle

First we stepped 'through the motions' of capturing an electromagnetic wave in a gravitically-induced circle (or cycle). Then you patiently observed while I 'held forth' on the subject of the superpositional helical wave sea known as the cosmos. Now I will bend your mind in a last wrinkle of the wave foundation of charged particles. How does the lightwave behave now that it is bound in a loop?

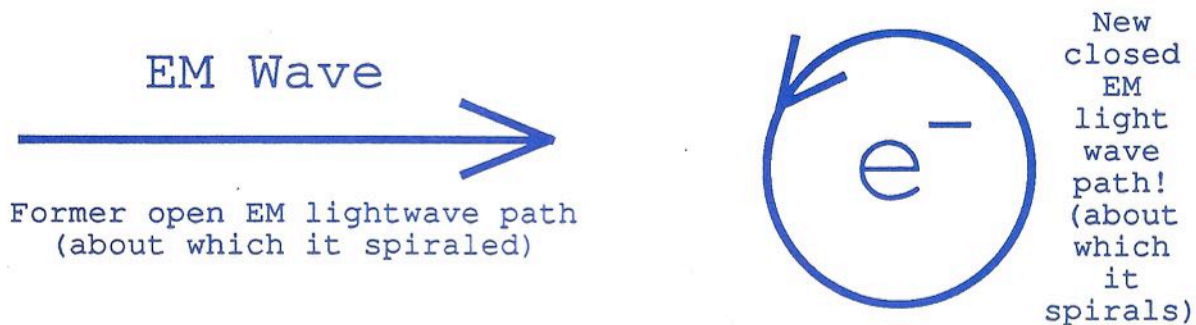

But where are the spiraling electric and magnetic vectors? And the gravitic vector curve?

The above illustrations only show the propagation path of the center of the spiral, they are the gravitic vector curves. Note the 'linear' path on the left should actually be slightly curved, as it is actually a geodesic. Now that we know where the geodesic lies, we simply have to put a spiral (like a slinky) around it to show how the EM vectors spin:

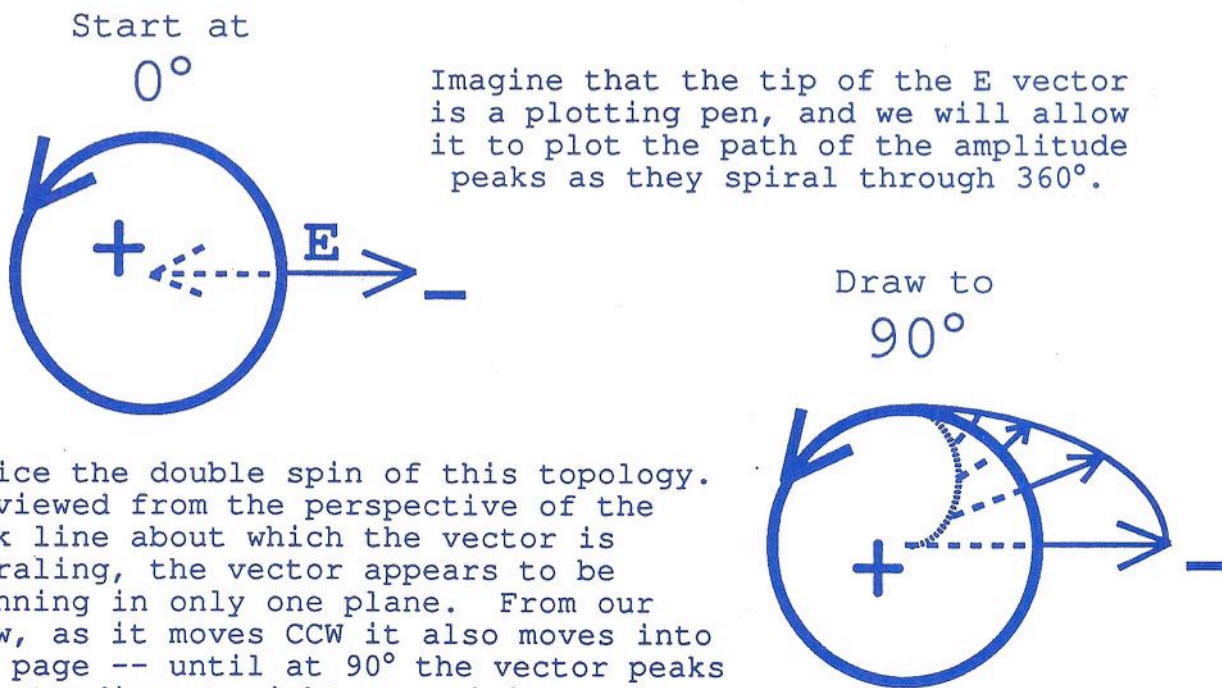

Notice the double spin of this topology. If viewed from the perspective of the dark line about which the vector is spiraling, the vector appears to be spinning in only one plane. From our view, as it moves CCW it also moves into the page -- until at  $90^\circ$  the vector peaks are standing straight up and down. At this point the vector magnitudes have reduced to zero (neutral), and are about to reverse sign and increase.

Draw to  
180°

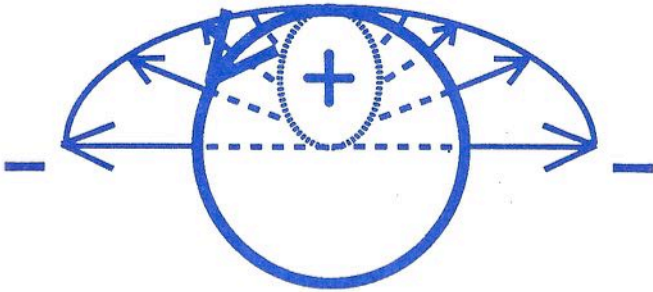

We are about to witness the world's first qualitative demonstration of the origin of charge -- simply a sleight-of-the-hand disappearance trick (topological folding).

After 90° the negative vector dwindled to neutral. From 90° to 180° it will now go from neutral to its positive peak. But what is this? It is now going into the interior, yet it is positive now! And it remains positive until 270° when it goes through neutral, and become negative again as it moves into the exterior!

Draw to  
270°

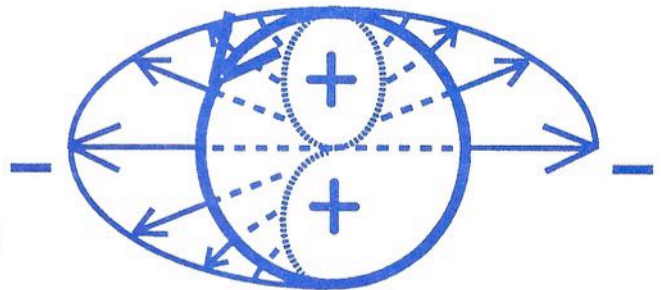

Draw to  
360°

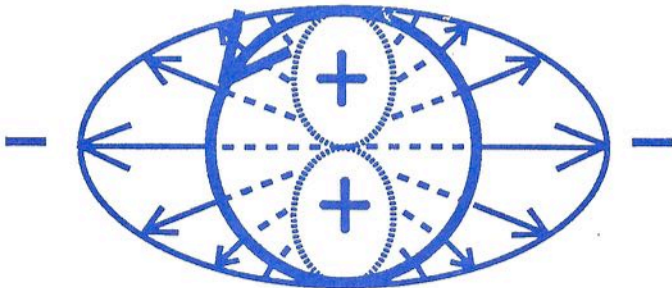

Very interesting! In the case of a spiraling lightwave the electric vector potential was open -- i.e., both the negative and positive ends of the vector lay 'outside' to influence the environment. Here, the negative end remains outside the particle -- and the positive end stays inside. Won't this have major consequences on electron/nucleon relations and shell topologies!

The electron achieves stability through closure. All its electric vector inertia (or energy) is self referential! Its external dominant negative electric field is established and maintained with respect to its internal positive electric field!

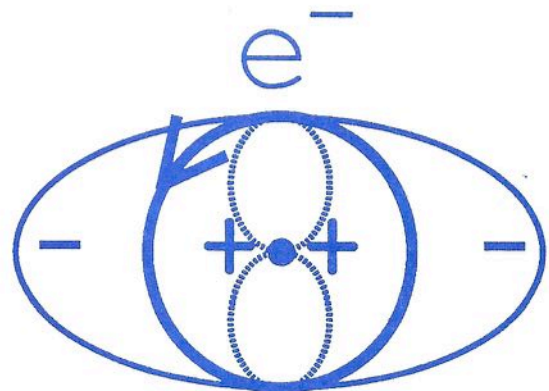

# A Metric Relativity

How does this topology translate into the corresponding models for the proton, and for antimatter? It is simply a matter of standing the electron illustration before a mirror to get the positron illustration. The spin reverses (CCW to CW) for the same polarity (north or south), or equivalently keep the spin and reverse the polarity. Then change the negative charge region to positive, and positive charge region to negative. Imagine here that you are holding a mirror parallel to the page and seeing the  $e^-$  reflected into an  $e^+$ .

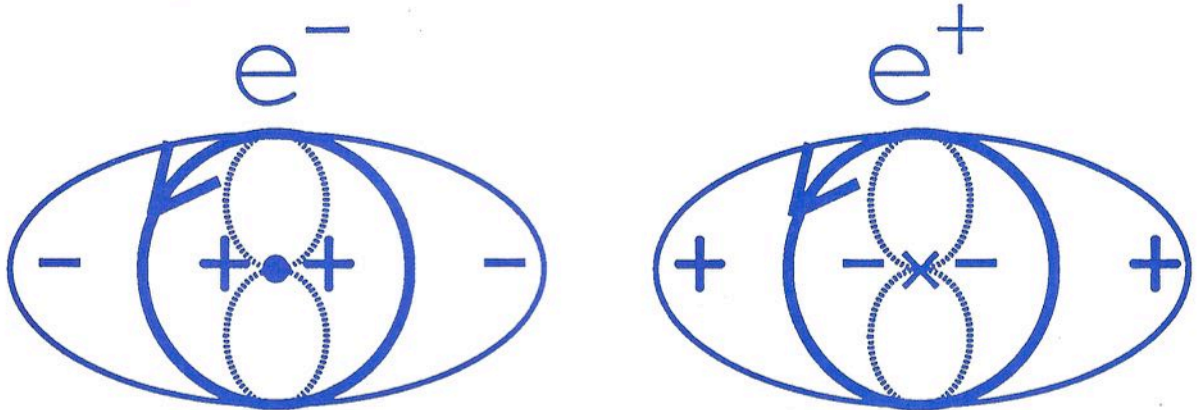

Another way of thinking of the electron or positron is visualizing its linear motion in a filament. Looking at the electron on the page, it is spinning CCW as it comes straight up out of the page at you (along the axis of its north magnetic pole). The positron can be imagined with an antipropagating (or 'time' reversed) linear velocity -- it plows into the page, following its northward magnetic pole.

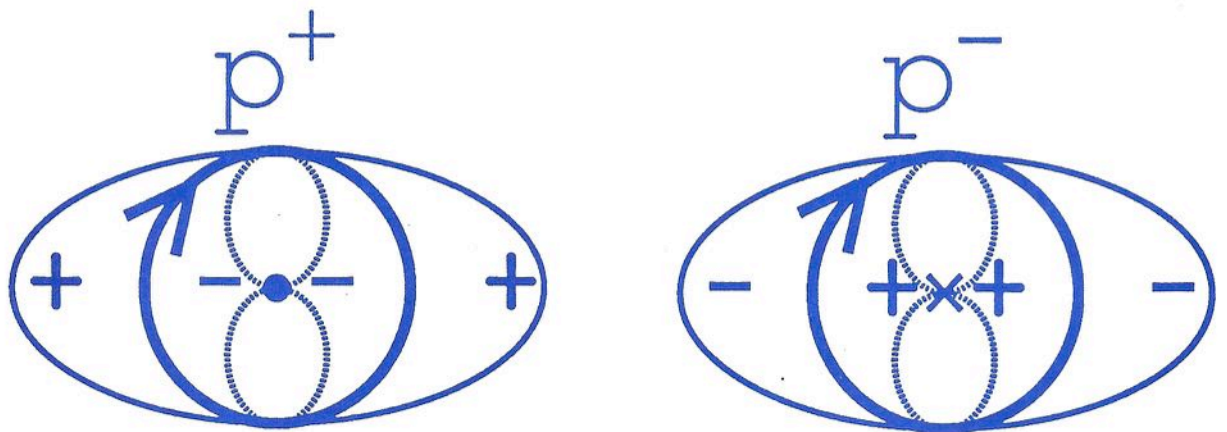

The proton belongs to the matterverse, like the electron, and hence also has righthanded spin, charge and polarity relations. It can be illustrated exactly the same as the electron, if we do not look at the fine detail. The fine detail is that the dark spinning circle in the electron illustration is not meant to represent any 'thickness'. In the proton however, that circle has thickness, the  $r_{p2}$  inner twist radius.



## Wave and Particle Properties

Light  
Wave

0/360°



90°



180°



270°



Wave OR Particle	$\mathbf{a} \times \mathbf{x} = \mathbf{c} = \mathbf{d}$			$\mathbf{d}$	$\mathbf{d}$	$\mathbf{d}$
	Electric Charge (Voltage)	Magnetic Moment	Spin (Hand Rule)			
0/360°	-0	+1	CCW -	+	+	+
90°	+1	-0	CCW -	-	-	-
180°	+0	-1	CCW -	-	-	-
270°	-1	+0	CCW -	+	+	+
Note: LightWaves are always CCW spin -- that is they are measure of electron (or virtual positron) current, not proton.				Matterverse EM waves are righthanded, yet positive charge phasecycle appears as virtual positron.		
$e^-$	-1	+(S)	CCW -	+	+	+
$e^+$	+1	-(N)	CCW -	-	-	-
$p^+$	+1	+(S)	CW +	+	+	+
$p^-$	-1	-(N)	CW +	-	-	-
<p>Note: Previous spin, polarity, charge &amp; parity 'standards'</p> <ul style="list-style-type: none"> <li>-- 1) Electrons flow in negative <math>\mathbf{E}</math> (voltage) direction;</li> <li>-- 2) Positive 'hole' current is opposite to electron flow;</li> <li>-- 3) Right-hand rule, fingers curl CCW, thumb is direction of 'hole' flow (North <math>\bullet</math>), hence South <math>\mathbf{X}</math> is electron flow;</li> <li>-- 4) Positive parity is matter, negative is antimatter.</li> </ul> <p>** I've conformed to rules 2 &amp; 4, but not to rules 1 &amp; 3 **</p>						

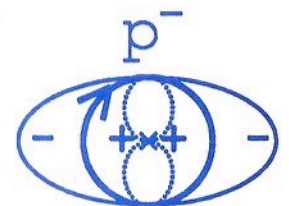
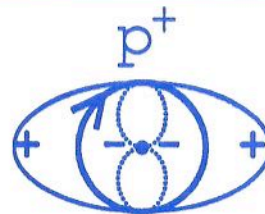
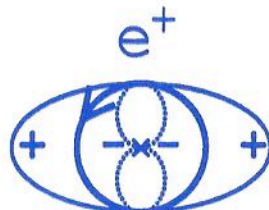
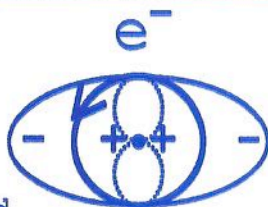

Charged  
Particles

## *The Five Matters*

© Millennium Twain  
20 May 1994

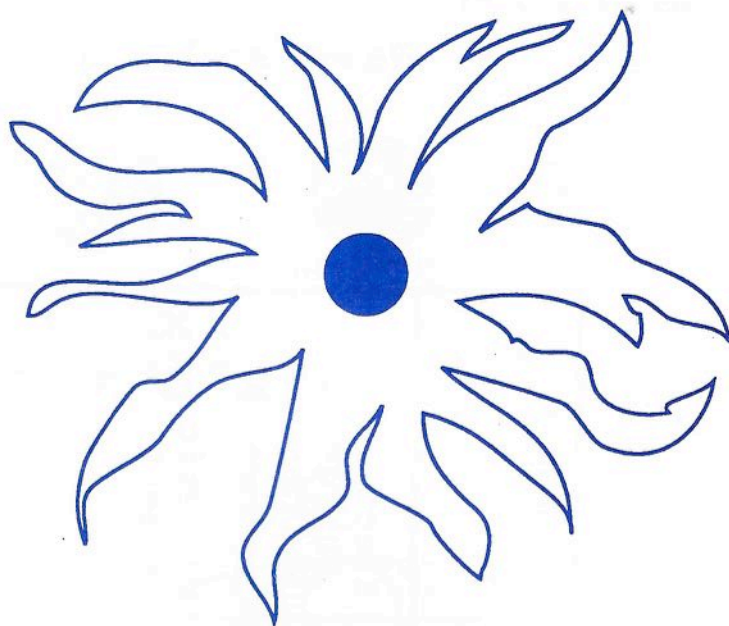

*The sky is made of fire,<sup>(2)</sup>  
Our heaven's filled with light.<sup>(1)</sup>*

*Smoke<sup>(3)</sup> and steam cloud my horizon,  
And shield true cosmic sight.*

*Water-<sup>(4)</sup> borne intellects,  
Trod solidly on this earth;<sup>(5)</sup>*

*Call pillared flames<sup>(2)</sup> a 'vacuum' --  
Infinite timeless rainbow,<sup>(1)</sup>*

*the 'night.'*

From Timothy:

### Question #1)

It appears to me that Millenniums' contention about light's unlimited and variable speed is both conflicting and not conflicting with Russell's Cosmogony. As Larry points out Russell did agree that light travels at velocity C and at the same time he said that all motion is illusory and nothing travels. He also said that all things are light or made up of Light. How are we to reconcile these points of view? I reconcile them by seeing that they are points of view.

If we see and agree (this agreement is an arbitrary language naming agreement) that all things are made up of Light we have made the word Light mean the the One thing there is, the undivided substance or you can call it spirit or whatever you wish. In this way the word Light is the same in meaning as the word ether (or aether, inertia, aenertia, etc...). It means the Only One thing there is; it is the point of view that sees Universe as One. It can also be the point of view where we stop dividing ( or analyzing) any thing into parts; or where we do not multiply parts into a whole. We emphasize and recognize the Whole One. In this way all things are Light.

If all things (parts of the Universe, parts of the ONE whole thing) are Light, then obviously these parts are all moving at variable speeds. The phenomena that science and we all recognize as 'light' has been measured and found to move at velocity C which is what at least part of the Michelson Morley (and Miller) experiments purported to prove. I understand that these experiments were supposed to prove the non-existence of the ether which I don't understand how it did or could have.

A paper by J.P. Vigier published in *Apeiron* Vol.4 Nr. 2-3 Apr.-July 1997 states that "What the text books do not say, however is that, although the Newtonian ether drift prediction did not have the anticipated magnitude (i.e.  $\sim 320$  km s in the apex of the observers absolute motion), *the observed effect was not zero in Michelson's famous experiment*, as later confirmed by a (presently almost forgotten) set of very detailed and very careful experiments by Morley and Miller. These experiments were ongoing from 1881 to 1925.

If the ether does not exist then what do we have in supposedly empty vacuous space? We have to be able to conceive a thing to conclude it. What does the concept of nothing or vacuum mean? I conceive that nothing means change of state and/or place (they both occur in all cases simultaneously). Nothing also means the reverse point of view same thing as infinity in that zero is the limit of dividing or subtracting while infinity is the limit of multiplying or adding. They are the limits of measurement. As such they are One concepts and words.

An absolute vacuum means no movement, no thermal hot or cold, electro/magnetic, light/dark, gravitation or radiation phenomena - period. This is a One concept. The whole Universe experienced or conceived as One could be named a Vacuum which in this case would carry the meaning of a One word or a word with no opposite. This then I understand to be the same as an infinite pressure condition as well. The concepts of infinity and zero are conditions with no opposite, the limits of measuring and limits of polarized conditioning. The whole Universe conceived as being in absolute balance is beyond polarity.

A relative vacuum is the same as a relative pressure condition that has more or less of ther-

mal, radiation/gravitation, in/out motion, etc...

I don't understand, can't conceive how space, vacuum or ether can be conceived any other way than as some thing or as I've outlined above. If the Michelson Morley experiments were supposed to prove the absolute speed of light at C and part of the proof were that there is no ether then it appears to me that it did not prove this. Again, as J.P. Vigier points out, ongoing experiments did prove the existence of an ether or continuous substance with varying densities. It appears to me that light must vary in its travel through varying substance, even in "free space" and this space also varies in density.

When Walter Russell says that nothing moves, that all motion is illusory, I can conceive of this as all motion is an equal and exact balance of inward towards a center and outward towards a periphery simultaneous motion that in the mutual cancelling sums to Zero. But I still move as I walk across the room or type these words even though each movement is balanced by its opposite and the whole Universe adjusts and / or moves in concert with my movement. Or, I am being moved by the Universe. Depends on point of view.

J. P. Vigier concludes in his article that the Michelson and Miller results showing a significant ether drift velocity are true and that a real ether exists that is compatible with relativity theory provided one introduces a non-zero photon mass. I agree with him and must echo that I can't conceive of any part of Universe having no mass. Mass or density is one of the eighteen dimensions that all parts of Universe possess in the Russell Cosmogony. Vigier feels this needs to be retested by new experiments.

The Russell's felt the Einstein equation was correct for one half of the journey of the whole

journey of mass into and out of more or less form or mass/density. See their *Home Study Course* units 10 & 11 and *Atomic Suicide?*.

Larry Tiegs says that a variable speed of light would be like changing the length of a ruler rather than a fixed one. I feel there is more to this concept that I need to understand but will express my vague musings about it now.

We generally differentiate things or parts of Universe by the light waves given off them that are at different wavelengths thus different colors. By what Larry said about the formula the speed of light = frequency x wave length, it seems that the idea is that if a wave is short compared to another, then science says that it will move as fast over the distance the wave travels as one that has a longer wave length by having a higher frequency. If that is so, then it still appears to me that one, I repeat one wave, that is longer than another, travels over a greater distance than a shorter wave and therefore must travel faster than a short wave if they "both travel at the same speed". How can a shorter wave cover the same distance in the same time as a longer wave? It seems that the idea science has in the frequency wave length formula means that say if a wave length of one step (distance) has a frequency of two (two steps occur sequentially in time over a distance of space) then those two steps will cover the same distance of a wave length of two that has a frequency of only one. But, that still seems to me that the light wave travels at different speeds. I suspect that point of view is important here but do not yet see the full implications of it. I do not know how to prove it at the moment.

I think that Russell mechanics i.e. the vortexual centripetal/centrifugal motions within the cube sphere wave field boundaries demands a

variable speed of light. If this model is a model for all things then it must be a model for light as it approaches or recedes from a gravity centre - even if he stated he believed the speed of light to be a constant C.

In reference to Larry Tiegs' comment that a radiating wave can not be called a gravity wave I refer to my book *In The Wave Lies The secret Of Creation* pages 32-33. These pages discuss what Russell said about Gravity and about gravity. He used the word in two different meanings. These I call a One (Gravity) meaning and a Many (gravity) meaning. In the many meaning he defines gravity as Larry states he does as only the inward bound compressive windup centripetally directed motion. An example is pg. 135 of *Atomic Suicide?* where it says, "There is no force of any nature which holds it (an atom) together by an inward pull. Nature does not attract nor does it repel. It compresses within a vacuum.". In the other One meaning for example on pg. 719 of *The Home Study Course*, he says Gravity, "both multiplies and divides by thrusting inward from without to compress and outward from within to expand". In this example the word Gravity carries the meaning of inward bound motion or gravity and radiation or outward bound motion.

### Question #2)

I think that Light is a vortex wave and more, i.e. it is a cube/sphere and all its variants and it is both a particle and a wave. We can have more than one point of view. The Russell's use the cube/sphere as the consummate form(s) of creation. As such this is a model for all things including light waves or particles. I see the particle or wave concepts as points of view that are taken for describing the phenomena we call and measure/ record/recognize as light. A wave has three space dimensions and a point

can too. Perhaps I am assuming that they meant the cube/sphere archetype to mean it was a model for all phenomena, but then if not that then what did they mean by the 'consummate form of all creation'.

I think Millennium's model is congruent with the Russell's model and you can judge for yourself by studying the letter printed in this issue he submitted to further explain his ideas about eliminating the word gravity and using the word/concept of inertia and more.....I think Millennium's model as being developed in this model and in further explanations that he has written me that I intend to publish next issue with his ok also are congruent steps that I have been attempting to take to describe the dimensional equations and geometry that unify all phenomena. Geometry is implicit in Mechanics and vice-versa.

Larry makes a point in his response that we live in a thought wave mind only Universe - that all else is imagination; and that any thesis demonstrating the relationship between light and all phenomena such as energy, heat, electricity and polarity will not be the long sought after grand unification theory, because you and I and what we perceive are only concepts and how can you unite what never was divided but only seems to be.

I know that nothing is (absolutely) divided (and only seems to be - if we do not see the whole connected cycle). My effort to give dimensional equations and express them as "equivalent" and a geometry for all phenomena such as gravity /radiation, heat/cold, electricity/magnetism, light/darkness is not to unite something divided, even though I used the term "unification theory". The purpose is to understand the universal mechanism sufficiently and in a way that will allow me and all

of you who might want to get this understanding to create a new technology from the understanding. If we can understand the geometry/mechanics of these phenomena and how they are all related then it appears to me that we can possibly make more obviously direct or maybe novel means of conversions of Heat to Gravity to Light to Electricity to etc and vice-versa.

In this sense I think there is a grand unification theory and that is my understanding of what attempts to unify all phenomena were partly about.

### Question #3)

I think that perhaps what Millennium means by lights' unlimited and variable speed being a function of frequency relates to what I suggested earlier about the relationship between a wave length and its frequency. Also I think that perhaps he means that the speed of light varies as it moves closer or farther away from a system center. In other words light traveling around the nuclear center moves faster than it moves at the periphery, i.e. the electron as a light entity is moving in Russell's' terms in a centrifugal spiral away from the nuclear centre and centrifugal motion is decreasing speed while a proton in Russell's' terms is a light entity moving in a centripetal spiral toward the centre and is increasing speed. Perhaps we sense or measure this motion as the frequency of light? What do you think? Is there a way to test this hypothesis?

Following are comments on Larry Tiegs' comments to my answers in the last *Fulcrum* : Russell's Cosmogony is complete in that it does give a universal systems model and with sufficient detail to be clear to even me that it is a universal systems model. Yet, at the same time it is not, in that he even wanted to write volumes more but did not live long enough to

do it nor did he give a model for all the phenomena I have listed that relates and differentiates while unifying them all. In other words he did not show what is the structure, the three dimensional wave body that we sense/measure as heat and what is its relationship to the structure... we know as gravity etc.... I do not think that the mathematical formula I am searching for is simply to satisfy "dual thinking, one-way minded scientists". If Russell had done what I am attempting to do I understand that it would have been true. Dimensional equations are not just numbers, they give the relationships between different phenomena and in doing this at least imply some geometry and mechanics. I think that both halves of nature's cycle can be measured. We can measure radiation as well as generation which are the two halves of nature's cycle which can also be expressed and measured from other views such as compression and expansion etc. What does Larry mean that the invisible half can only be known. What did Russell mean by similar statements? I think the answer to this is something like I can't know the taste of chocolate by measuring it but I can by tasting it and I can't know God by talking about God but only by experiencing God. Many mystics like the Yogis (who in my estimation are also scientists) say as Russell said that cosmic conscious illumination is experience of Reality disconnected from the senses of our temporary abode in this body. They say a lot more about it and this is what Russell hints at when he says the nature of the sensed electric wave universe had no reality whatsoever.

The "invisible" half of natures' whole two way electric wave cycle can be measured as well as known. We can measure gravity and radiation, heat and cold, electricity and magnetism, light and darkness, generoactivity and radioactivity and even life and death. I. E.: a young generoactively predominant element rotates slower

and revolves faster than an older one. When it reaches maturity it rotates and revolves in equal potential or it is a gyroscope straight up where before as a young element it was approaching perpendicular and vice-versa as an aging element. We can even measure a thought and thoughts “out” of our bodies. But where are the boundaries of our bodies if not the farthest reaches of Universe? But the measuring is not the same as being aware of the thoughts of others or even aware of our own thoughts!

I think the equations I am searching for and the Geometry will be simple once I have written it. Until then it seems vague and complex.

Larry, I think you are correct in that a unity equation will express our two way continuous changing Universe. Any such equation will have to sum to balance and express both halves of the cycle. But, I do not think the only unity equation possible is  $zero + zero = zero$ . Here is another one with the same ultimate meaning as yours,  $infinity + infinity = infinity$ . They both are unity equations and express the limits of measuring; but not the one I am looking for and they are not ones I can use to engineer more direct conversions of say gravity to heat or electricity.

Does  $zero + zero = zero$  as the only unity equation possible describe the “world we sense and the invisible world we can only know with our minds as a holographic cinema, ourselves the actors, the whole scene and all the actors as only a flicker in the Creator’s imagination.” ? It does but it is not the same as experiencing it and it does not give me much to create another version of the cinema with or even recreate a part we experience.

I also encourage the thought process involved

in developing a Grand Unification Theory and request that if any of you have one send it to me as well as to Stephen Hawking. If he gets two or three a week he has a lot to consider every week and I have had nothing but the ones suggested by Millennium Twain and Larry Tiegs in the last several months. You may come up with the model we need to manifest the new technology needed to support a sane and sustainable civilization.

I was not clear enough at least to Larry and likely to many in my comments about what I thought Russell might say in regards to the One or the Many being “real”. I will try again.

I do not think Russell was aware of the structure of language as being analogous to the universal systems model, the see-saw, they use in the HSC. They did not see the use of One and Many and Relationship words and their relationship even though they used the language machine well instinctively or habitually as most of us do more or less well. If they would have recognized the relationship between language and this model I think we all would have less to dialogue about in *Fulcrum*. In any case my speculations about their awareness of the language machine aside I will attempt to make myself clearer to Larry Tiegs if not to some of you and clearer to myself as well. I do not mean that the Many is effects or phenomena and the One is cause. The Many is awareness/recognition of the Universe as demonstrating individuation. The One is awareness and recognition of the ultimate unity of all individual parts. The ultimate meaning of any Relationship is identity - the parts are literally inseparably One. Relationship is awareness of the simultaneous reality of two or more things as being individual and as One at the same time. Awareness of the nature of reality is embedded in our language.  $2+3=5$ . Two of any

things plus three of any other things are related, connected, and detected as being five things that are all ONE. Two and three are awareness of the many. Five is awareness of the One. Plus and equals are awareness of Relationship.

Russell's Cosmogony recognizes that the Universe is made up of complementary opposite aspects of which he gave many examples such as centripetal and centrifugal motions, compressed and expanded conditions, and male and female polarities. These are what I mean when saying I understand him to recognize the reality of the Many. He did not deny that these exist. He expressed that to see them as literally absolutely alone or separate was an illusion. He also said that these seeming opposite conditions or aspects were a unity or One and therefore the One is also reality. By stating that polarized conditions are a Whole the Russell's in effect say the ultimate meaning of any relationship (which is another name for polarized condition) is identity.

It appears to me that when a person habitually sees or is aware of their world as being sharply individuated that they are more aware of this and give more reality to the Many aspect like a scientist tends to do. A mystic tends to be aware of their world as One and Philosophers are more aware of relationship. For example each of us can be aware of the Russell work from these aspects. Their work contains science or a measuring, or Many aspect like the science diagrams for example and it contains broad generalizations and summations like the Divine Iliad poem which emphasizes the One and it contains philosophy which emphasizes Relationship such as Lao's book *Love*. Of course all of their work contains all aspects in every part; just the emphasis differs in one aspect of the work from another.

When I said it was my opinion that Russell emphasized the One or "spiritual" Universe as being reality I meant it in the context as just given and by not giving it was not clear enough for Larry to understand what I meant. It appears to me that the bulk of Russell's work is more in the vein of a mystic with the emphasis on the One aspect of reality and a greater use of language in that mode as opposed to the other valid modes available.

If any of you care to understand more about the "language machine" I refer you to *In the Wave Lies The Secret Of Creation* where I relate language to the universal systems model the Russell's used. The model they used is the see-saw or lever, the simplest machine, which can be a model for the language machine too.

I think Russell's statement that the sensed electric wave universe of motion, "had no reality whatsoever" is worthy of contemplation and questioning. What does this mean to you? How do you live with your understanding of this statement?

Larry suggests that it is better yet to understand the "field" if I wish to produce an octave of elements. I agree and say that when I can fully express my understanding of the field I will be able to express the geometry of the field and express it as dimensional equations that relate say the field science calls heat to the field called gravity, and the field called electric, called etc. To make clear what is meant by such expressions as "field" is what the search for a GUT is all about for me. I think Millennium Twain is uncovering the same thing in his questioning and attempts to model the hydrogen atom, the electron and a light wave, etc. Larry and Millennium are helping me uncover it by dialoguing with me about the subject. That is what dialogue in *Fulcrum* is about, uncovering



or becoming aware of reality.

#### Question #4)

Here is what I have been able to uncover about a scalar wave thanks to my associate Toby Grotz. If we run two currents in opposite directions right next to each other, say in two wires, then what are called the E and H fields ( the electric and magnetic fields respectively) cancel each other out. We know these E &H fields exist and are named such because a compass needle will respond to and in the H field but not in the E field and gold foil leaves will respond to and in the E field but not in the H field. This is why science names these fields as such. When the wires are oriented in this specific shape (geometry, mechanics) they zero sum vectorially and we do not witness the compass needle and gold leaf effects anymore. Yet there is a potential, something there that we can measure with an interferometer as shown in the Bohm - Aronov experiments where the A field ( the curl free magnetic vector potential) still exists. This A field the curl free magnetic vector potential is the scalar field. We sense its existence as the interferometer responds to the A field. The A field reveals itself when a light beam is split into two paths that travel the same distance and travels near but not in another field that should not effect the split light paths just as there is no interference when the split beam paths travel without this other nearby field. The nearby field is created by a solenoid which creates its own fields around it but it does not extend out to touch the light beams. Yet when this field is near the light beams no longer cohere when they reach the target; thus the A field reveals itself. This all sounds again like proof of the ether to me. There is no absolutely void space in Universe, just varying densities of the One (substance or spirit).

The E and H fields appear to correspond to what Russell called the centripetal and centrifugal directed generative and radiative fields that constitute the Gravity field. The whole One or the Gravity field of Russell appears to correspond to what is called an A or Scalar field. The radiative and gravitative fields do sum to zero in Russell's thinking just as the E and H fields do in scalar waves and both have potentials within them.

In Russell's thinking the carbon atom or wave as the most perfect expression of the archetypal cube/sphere geometry demonstrates the greatest apparent ability to attract and repel. It demonstrates the greatest potential. This appears to be analogous to a scalar wave potential. In Russell's Cosmogony each individual unit ( the Many) has its boundary planes of zero curvature that insulate it from and yet relate it to every other boundary plane/field (relationship) in Universe (the One) Every such individual system has its potential and can be measured perhaps just as a scalar wave potential is measured.

The following diagrams illustrate the E and H fields and Russell's two way fields:

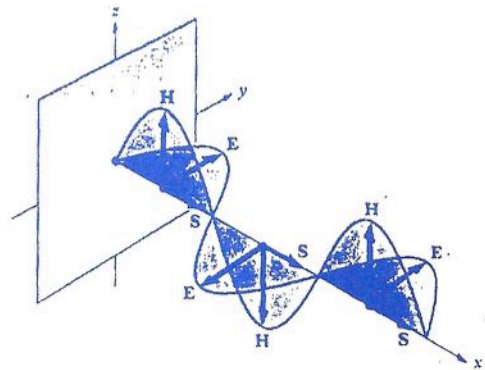

Fig. 36-10. E-, H-, and S-vectors in a sinusoidal electromagnetic wave traveling in the positive x-direction.

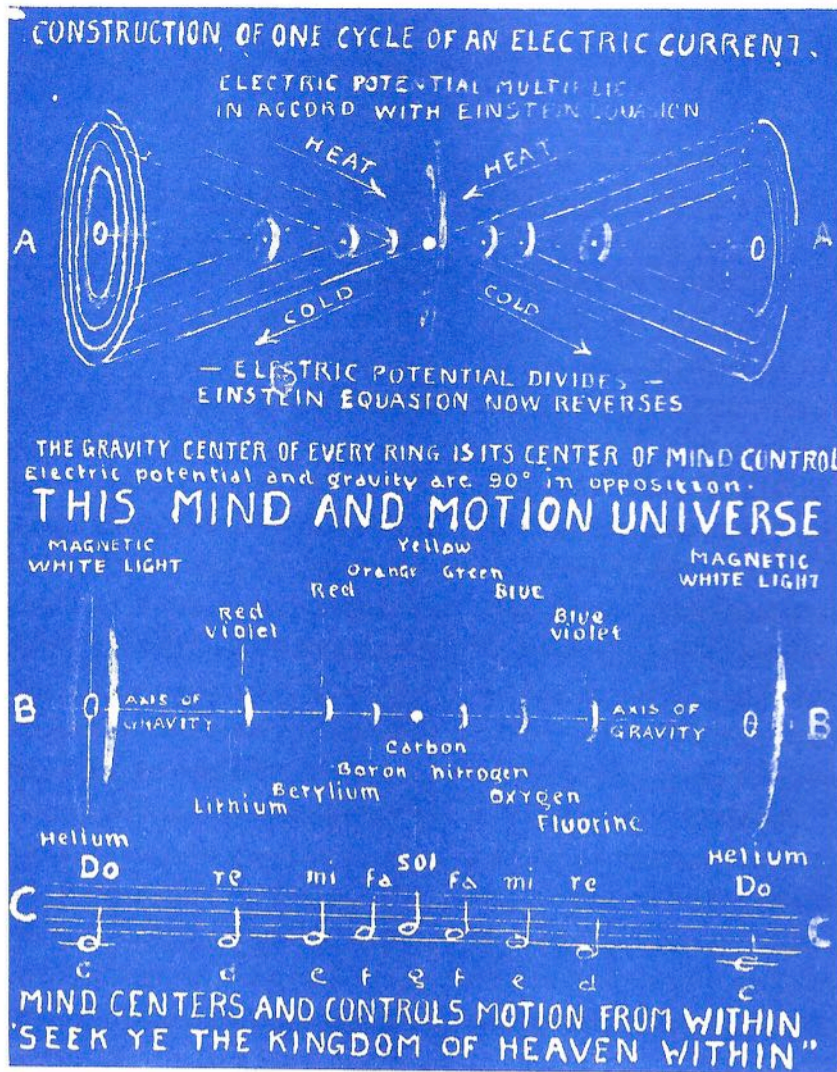

Fig. 42. Three examples of tonal rhythms of the electric current. Every cycle of an electric current is a complete octave of four pairs and an inert gas keynote. All motion in Nature is tonal and rhythmic. Its rhythms are geometrically and mathematically cube-based.

Another way to consider a scalar wave is to think of squeezing a ball between your hands. The pressure of your hands on the ball cancel each other or sum to zero so there is no apparent major movement of the ball to one side or the other. Externally nothing appears to be happening. Internally there are stresses on the ball; motion, heat, electric currents and more are created. This is similar to a scalar wave potential. And, the ball moves some.

I do not know how this might be considered a "gravity wave" other than that scalar and gravi-

ty waves both appear to pass through everything and can be perhaps measured/detected by similar means. Some scientists like Greg Hodowanec and Bill Ramsey who have written about this in the *New Energy News* have claimed to have measured "gravity waves" by using capacitors connected to operational amplifiers to detect voltage fluctuations in capacitors. Capacitors are E field storage devices; therefore we might consider they are detecting changes in the ether which are changes in gravity and they measure and make electric fields directly from gravity. Ramsey

has recorded the effects of planetary alignments using gravity wave detector circuitry and recorded these changes on audio cassette tapes which sound like Gregorian chant. It is the sounds of the Universe talking to us.

How might we engineer this to demonstrate a new technology? Perhaps as Tom Bearden has suggested in his many books about the subject it already has been engineered into weapons and communication systems that are undetectable by our usual technology. I do not yet have suggestions for how to engineer it; but having some grasp of the concept gives me a starting chance. This sounds related to Russell's goal of wireless transmission of ener-

gy just as Nikola Tesla was reputed to have said he had done. Create a balanced hidden potential, a scalar wave, give it longitudinal direction to wherever desired and release the potential in a non-hidden transverse form that we recognize as electricity/magnetism, heat/cold, explosion/implosion. The patent paper and Archival materials may have some bearing on this. The Russell's intention to research and develop wireless power projection like Tesla's intentions hints of scalar transmissions.

Abstracting energy from the atmosphere even if from radio transmissions suggests similar ideas. Why not abstract any of the energy that is there? Why only radio transmissions? Do any of you have any suggestions?

## Letter to the Editor

10 April 1997

Dr T Binder  
Fulcrum Science Journal  
P O Box 250  
Waynesboro  
VA 22980

138 Ochiltree  
Dunblane  
Perthshire  
SCOTLAND  
FK15 0PD

Dear Dr Binder

I would be most grateful for your assistance in my quest for information regarding Biblical prophecy. My enquiry may of be of interest to researchers in Theology, Archeology or Time physics areas.

For many years I have tried to find the method of prophecy used in ancient times, not the visions reported by "sensitive" minds, but the time and place predictions as in the old Testaments that I believe were derived from a knowledge of space / time geometrics. I have found evidence that ancient monuments were constructed not only as astronomical observation tools, but they could calculate vast numbers used to compute space / time geometrics. The basics natural units of measurement and geometry of the Universe being understood, determination of cyclic events was achieved.

The best testbed of space / time geometrics I have come across is the the works of Piazzzi Smyth and Adam Rutherford on the Giza pyramid. I have been able to identify space / time geometrics within the measurements and dates that the stone mathematical puzzle appears to give. I have tried to understand ancient science from the works of W Russel, John Michell, Robert Lawlor, Bruce Cathie, Ernest McClain and many others. I believe that at least once in human history the techniques of prophecy were applied because of a complete understanding of the laws of the Universe. We appear to be in a dark age at present basing our science on effects rather than cause, and

"chaos" statistics.

I have had great difficulty in collating ancient geometry as it is a different approach to the modern view of Universe. My interest in the Jewish connection comes from my only knowledge of the Jubilee time pattern of 49 and 56 years. I found recurring patterns of various 40, 49, 56 and 81 years, months, weeks etc. Also a series of 40-81 interlocking octave type system in other racial and cultural monuments and sacred symbols, but not mentioned as freely in the present days festivals and Jewish symbolism.

I would be grateful for any references to others who have investigated and correlated the ancient science of prophecy and the remnants of this hidden knowledge kept by the inner core of organised religion. There seems to be a similar system in the Indian religions where festivals and events are practiced to identify humans with the Universe, but the knowledge associated with the space / time geometrics of the ceremonies are lost or hidden.

I realise that many of my interpretations of ancient monuments and maths, organised religions, and the apparent inability of modern "chaos theory" and random Universe maths to generate the Biblical time periods puts me well outside the accepted academic views. I would be most interested in any correspondence with others who could furnish me with any information, also anything to prove my deductions are spurious and save me going down the wrong avenue of research.

I would be very pleased to recompense for any postage etc incurred by any replies.

Yours sincerely

  
James H Affleck

## Featured Articles

The following article first appeared in the *Journal of New Energy*, Vol. 1, No. 1, 1996. It is published by the Fusion Information Center, P.O. Box 58639, Salt Lake City, Utah 84158-0638. A quarterly journal subscription, \$150; single issues, \$45. It has been reprinted in *Fulcrum* with permission.

### MECHANISMS OF LOW-TEMPERATURE TRANSMUTATION

G.S. Rabzi

Ukrainian International Academy of Original Ideas. Southern Branch. Odessa, Ukraine

I feel it my first and foremost duty to express my sincere gratitude to the Distinguished Professor Bockris who spared no effort in providing for my visit here. It is largely because of the enthusiasts like him that science can progress.

All relevant literature on cold fusion available to date is basically a mere record of the results obtained from electrochemical cells. Everybody agrees that time is apt for an unorthodox theory capable of accounting for uncommon phenomena. I will try to patch this flaw by proceeding to theory from our experimental results.

[Samples of before and after materials here passed to the audience.]

A glimpse of the available samples persuades a viewer that something rather peculiar has occurred to the samples. And it has. An ordinary steel nut acquired the color of copper and diminished in size; magnetic stainless steel turned antimagnetic; asbestos became a ceramic-like material. What you can see is the outcome of low-temperature transmutation. Our experimental scheme is conceptually the same as many use for cold fusion. Those cold fusion cells are not unlike, featuring varied arrangements neglectful of the specific media therein entailing varied field patterns with respective varied interaction forces. The randomized fields thereof can be blamed for the divergence in the results. Our electrolyte-free device was constructed to allow for the specified control of the effect of those fields that provoke certain forces to trigger the transmutation process. We utilized the combined effect of both geoelectric, artificial fields, and temperature field. The latter can be described by a vector of temperature field gradient misaligned with vectors of the electric fields. We started our experiments in an attempt rather to observe transmutations in solids and liquids directly than to investigate, for example, particular behavior of hydrogen in metals. Resemblance between our schematic concepts inspires me to assume that similar phenomena produced by both cold fusion and our experiments must be likewise grounded in the same common laws.

But experimental results must be examined first. The history of our device dates as far back as 1958 when its first embodiment was developed with my colleague Arnold Fabrikant, a mechanical engineer. In our device, the following materials were processed: zinc, carbon, graphite, lead, table salt, silica sand, fuel oil; and different liquids (wine, alcohol, sunflower oil, etc.). Materials of the field-inducing electrodes varied for different experiments: copper, aluminum, titanium, or stainless steel. Now is as good a time as any to applaud Dr. Michael McKubre from SRI International who does not hesitate to confront the orthodox cold-fusionists with the physical, as opposed to chemical, nature of the processes involved in transmutation [1]. We support him with our results and theory.

1. Zinc has transmuted into copper (see sample). I brought here to show you the parent zinc sample; zinc in the process of transmuting into copper; the vessel where transmutation occurred with the residue of zinc pellets; the resulting copper product. In addition, here I have samples from zinc processing that were not lucky to be analyzed. The copper electrode plates with the implanted zinc are surprising with their overlayer of relative density  $9.59 \text{ g/cm}^3$ , while copper is known to have  $8.89 \text{ g/cm}^3$  and zinc  $7.1 \text{ g/cm}^3$ .

Other attributes of the composition still wait to be decoded. A slide shows the drastic difference between the parent and the processed Zn samples. The samples were investigated and micrographed by my colleague Dr. Kostenko whose does work on  $\alpha$ -irradiation.

2. Copper was implanted into a steel nut (see sample). No such composition is known to exist on Earth. The processed sample underwent qualitative spectral analysis. Fe appeared substituted by (Cu). The processed sample displayed mere traces of Fe. The reference nut after soaking for 6 hours in sulfuric acid lost 11.6% of its weight, while the processed one only 0.4%. It became corrosion-resistant and antimagnetic. Corrosion is 29 times weaker. Relative density of steel is  $7.78 \text{ g/cm}^3$ , density of copper is  $8.89 \text{ g/cm}^3$ . While density of the obtained composition is  $6.41 \text{ g/cm}^3$ . Other characteristics were left undetermined.

3. A stainless steel plate turned antimagnetic following implantation of the accelerated lead particles. After a number of years the sample still features antimagnetic behavior. I want to draw your attention to the stem. Though a part of the steel plate body, it was not affected by field and thus still is magnetic. Let me please remind you that lead is the finite product of uranium and thorium decay, therefore its transmutation is of special interest to us. Analysis suggests actual transmutation of lead into a group of elements (gold, cadmium, silver, germanium, palladium, osmium, platinum, etc.) absent in the parent sample and placed in the Periodic System ahead of lead (Fig. 1). This observation supports the claimed transmutation in our device.

Fig. 1

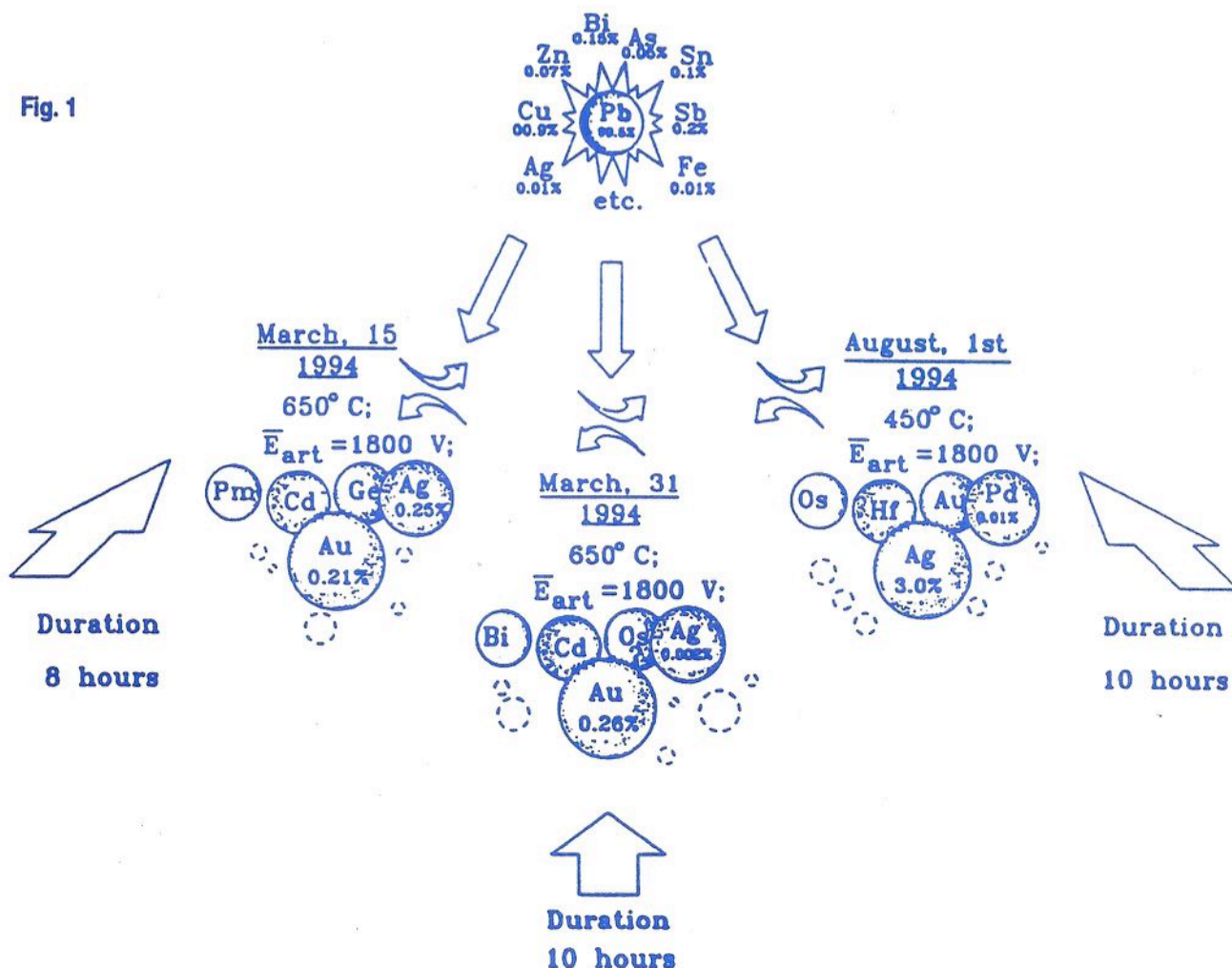

SOME EXPERIMENTAL RESULTS ON LEAD TRANSMUTATION

4. Transmutation of asbestos, high heat resistant sealing material, into a hard and light-weight mass took place under temperatures 750-800°C (see sample).

Electric field and energy utilized in our device made us persist in disclosing unambiguous mechanisms of their impact on material bodies and digging out the roots of transmutation and its stages. The available results furnished by both cold fusion cells and our device indicate inexplicability of their phenomena due to the absence of clear understanding of the processes involved. Studies by Louis Kevran in biologic field of knowledge corroborate the universalism of transmutation [2].

So far we have heard nothing about the excess heat liberation reported for the so-called cold fusion process. Such excess heat can result from certain inner forces liberated as energy that manifests itself, whether as an excess heat, or transmutational process, or both, depending on experimental conditions. Thus, energy is a manifestation of a certain process. To make my arguments more obvious, I invite you to have a look at this Ni-Cr coil with the implanted heavy particles of lead -- which fact, as we were taught, has no right to exist. Spectrochemical analysis of the processed coil revealed 0.05 - 0.08 percentage of lead. Such results cannot be achieved today except in very expensive and sophisticated reactors, while our device involves not only transmutations proper but also self-acceleration of the fission particles up to high energies at temperatures not exceeding 750-800°C. No radioactivity was observed in any of our experiments. I do not specify experimental conditions and arrangement of the device because these are things to be protected by patent (in process). Our device also claims to transfer radioactive atomic waste into nonradioactive waste.

It was not our prime goal, however, to well-instrument and protocol our experiments against possible fraud accusations, the sole purpose was getting the brief insight into the origin of the processes involved, be they transmutation or cold fusion.

The clue to this problem is a terrestrial charge that forms a vector of the geoelectric field in our device. It is widely recognized, but never substantiated, that the Earth is charged negatively. Should the terrestrial charge be "-", grounding would be impossible due to the electrons of current that ought to be repelled by the like charge. Lightning is known to strike earth, and what is lightning if not an electron beam? Should the terrestrial charge be negative, then ionization of atoms without heat input never would occur. But an atom is known to be environmentally-ionized. If the terrestrial charge is negative, atoms with orbital electrons would be ousted far upward -- which is never observed. It is simply another of the misleading shibboleths. In order to verify the positive terrestrial charge it is necessary to ascertain the processes in the Earth's core that generates the charge.

Radioactive processes in the Earth's core are accompanied by the stripping of the electron shells of disintegrating atoms with simultaneous liberation of huge energy. In this manner more heavy elements transmute into the lighter ones and are transferred to the upper part of the Periodic System. With their electron shells empty, the newly formed light elements expose the positive charges of their nuclei to produce the "+" charge of the Earth. Thus we know that  $^{238}\text{U}$  decays under the neutron exposure to engender Ba, La, Ce. Their atomic weights are lighter than uranium. Uranium nucleus with its  $238-82=146$  neutrons loses, while Ba, La, Ce are formed, respectively:  $146-81=65$  neutrons,  $146-82=64$  neutrons,  $146-82=64$  neutrons. These 65, 64 and 64 neutrons undergo fission accompanied by beta-particle emission and proton formation. Such a decay of uranium provokes a rise in the "+" charge of the nuclei, which is responsible for the Earth's positive charge. One example more. Ionizing the hydrogen atom by removing its electron makes the heavy proton escape into the protonosphere [sic] as high as 2,400 km from the Earth's surface, while light-weight electrons adhere to the Earth. It is only possible if the Earth is charged positively.



All material bodies in the near-Earth space are polarized in the manner of dipoles with positively charged upper parts which further supports the positive charge of the Earth. The number of the examples to prove the above statement are numerous.

The arguments were backed up by a 21-hour run where a glass disc 50 mm in diameter and 2 mm thick was continuously weighted by ordinary analytical balance in the artificial electric field. The disc was preserved between the electrodes throughout the experiment. When the anode "+" electrode was under the disc its weight increased, while switching the anode "+" sign to "-" brought a loss in its weight. With no artificial field present the weight of the disc was unaffected. Thus, I state that coupling of the positively charged geoelectric field  $E_R$  (that never in the past history was included into calculations), with the  $E_{art}$  artificial one involves a gain in weight of the disc, and removal of the field results in the loss in weight. [Can this be related to the Townsend bifield effect?]

Another proof, though indirect in favor of our reasoning: voltage reduces from 130 V/m near the Earth surface to 2.5 V/m at the height of 12 mm, which also supports the "+" charge hypothesis because the field intensity is widely known to be maximum around the charge.

The more orbits and electrons which the nucleus has, the better it is shielded from the direct interaction with the external geoelectric field. It is a well-known fact that shielding of the nuclear charge is included into the so-called effective charge  $Z_{eff} = \sum_{off} e^+$ . Effective charge is a fraction of the net nuclear charge that "shines" through the shield of orbital electrons. Out of 10 units of neon charge only 2.52 units manage to "shine through", while the remaining part is shielded by 10 electrons (Table 1).

Table 1 Effective charges of the atomic nuclei.

Atom	$Z_{eff} = \sum_{off} e^+$	Atom	$Z_{eff} = \sum_{off} e^+$
H	1.0	C	1.82
He	1.345	N	2.07
Li	1.26	O	2.0
Be	1.66	F	2.8
B	1.56	Ne	2.52

Hence  $\sum_{art} e^- > \sum_{art} e^+$ .

The difference between the net and effective charges is suggested to be called the acting charge  $\sum_{act} e^-$  which increases with the order number of an element [3,4]. The acting charge is expressed in terms of a number of orbital electrons. Their interaction with the geoelectric field involves formation of the effective electric charges in atoms throughout the near-Earth space, across the Earth, in its depths, and in the cosmos. The charge value  $\sum_{art} e^-$  exceeds the effective nuclear charge  $\sum_{art} e^+$ . Hence, the acting charge will be  $\sum_{act} e^- = \sum_{art} e^- - \sum_{art} e^+$ .

Interaction of  $\sum_{act} e^-$ , acting atomic charge, of any element or individual body with the terrestrial charge is governed by force

$$F = \sum_{act} e^- \cdot E_R = \sum_{act} e^- \cdot \frac{e_R^+}{R_R^2}$$

where  $E_E$  is the intensity of geoelectric field  $E_E = \frac{e_E^+}{R_E^2}$ ; where  $e_E^+$  - terrestrial charge in Coulombs, and  $R_E$  - radius of the Earth in meters.

Then 
$$F = \sum_{act} e^- \cdot \frac{570000}{(6370000)^2} = 1,405 \cdot 10^{-8} \cdot \sum_{act} e^-, N \quad (1)$$

Equation (1) shows that the  $\sum_{act} e^-$  value introduced here to describe the acting charge of orbital electrons is the principal factor that controls all sorts of atomic transmutations, radioactivity included.

The atomic charge is constant for every element and increases continuously from the lowest in hydrogen, to the highest in uranium with its poor decay resistance. Thus,  $\sum_{act} e^-$ , the acting charge, is a measure of the atomic radioactivity.  $\sum_{act} e^- > 0$  for all elements. So we conclude that atoms of the elements are not neutral with regard to the external field but negatively charged.

An atom and its nucleus can be destroyed or brought to decay by stripping electron orbits. We can induce nuclear decay and obtain a less radioactive element. For this purpose radioactivity of the parent element  $\sum_{act} e^-$  is achieved by removing a sufficient number of electron's atomic orbits to obtain for a new element the expected decay byproducts.

This virgin-fresh equation is introduced here for the first time. It enabled us to also estimate absolute atomic weights of all the elements in the Periodic System and to place the zero, initial group. Following this equation hydrogen was placed firmly in the rear of a non-atomic product, namely neutrino (Table 3). With regard to hydrogen it is necessary to obtain an insight into the origin of the fantastic coincidence of proton and electron absolute charge values, as opposed to differences in their masses and properties.

The proton absolute charge  $e_p^+$  cannot equal that of an electron  $e_e^-$  because specific charge of the electron  $\frac{e^-}{m_e}$ .

is 1837 times higher than that of proton  $\frac{e_p^+}{m_p}$ .

Masses of proton  $m_p$  and electron  $m_e$  differ. The proton mass  $m_p$  is 1837 times higher than that of electron  $m_e$ . Therefore, a single particle with specific charge  $\frac{e^+}{m_e} = \frac{e^-}{m_e}$  is able to equilibrate with the

specific charge of an electron. Only the positron meets this requirement. A positron can be anchored in a proton only by an electron, thus producing an electron-positron pair (Fig. 2). Nuclear charges of atoms are generated by the terminal positrons in protons. **The fact is beyond all doubt because the identity both of masses and the largest opposite specific charges of electrons and positrons cannot but couple them constantly into the electron-positron pairs.** Mutual attraction between electrons and positrons gives birth to a new particle. The particle is oblate because the attraction force is directed along the geoelectric field. But what size is this oblate particle? As a proton consists of 1837  $e^-$  or 1837  $e^+$ , then proceeding from the classic radius of  $r_0 = 281.7938 \cdot 10^{-17} \text{cm}$ , the radius of the oblate pair will be

$$r_{obl} = \frac{2.817938 \cdot 10^{-15}}{1827} = 0.15 \cdot 10^{-17} \text{cm}. \text{ The force to oblate electron with positron is equal}$$

$$F_{e^+ \cdot e^-} = \left( \frac{e^- \cdot e^+}{m_{e^-} \cdot m_{e^+}} \right) \cdot \frac{1}{r_{obl}^2} = \frac{(1.602 \cdot 10^{-19})^2}{(0.15 \cdot 10^{-17})^2 \cdot (0.91 \cdot 10^{-27})^2} = 1.373 \cdot 10^{52} N \text{ [Newtons]}$$

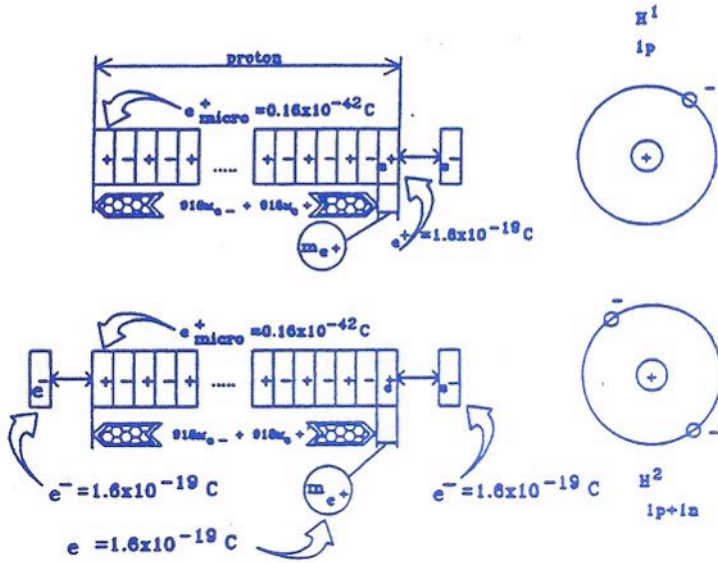

Fig. 2 Electron-positron pairs that constitute proton and neutron are essentially matter, eternal and non-exterminal – the basis of the Universe. Radius of the oblate electron-positron pair of  $0.15 \cdot 10^{-17} \text{cm}$  allows for constructing the nucleus with  $r_{nucl} = 10^{-13} \text{cm}$  from a large number of these pairs. The recognized mass of a proton  $m_p = 1837 m_e$ , mass of a neutron  $m_n = 1837 m_e$ . But since the masses of both electron and positron are equal, as well as their specific charges (though opposite in sign), we can represent the mass of a proton as consisting of 918 electron-positron pairs plus a terminal positron  $m_{e^+}$ , that is  $m_p = 918 m_{e^-} + 918 m_{e^+} + m_{e^+}$ , while a neutron consists of  $918 m_{e^-} + 918 m_{e^+}$ .

Attraction between the spatial electrons and positrons produces couples with underequibrated non-exterminal charges that do not annihilate. External noncontiguous surfaces of both charges preserve their stability in the couple as surface microcharges "+" and "-", that is neutrino. Thus, neutrino is an electron-positron pair. The value of neutrino microcharges can be derived using the mass of the neutrino. At the Institute of Theoretical and Experimental Physics in Moscow, the neutrino mass was found about 20,000 times lighter than that of electron [5].

From the above, mass may be defined as the product of the active negative charge of bodies and geoelectric field intensity. Hence, neutrino mass is  $m_v = \frac{m_{e^-}}{20000} = \frac{9.105 \cdot 10^{-31}}{20000} = 4.5 \cdot 10^{-35} \text{kg}$ . To verify the introduced notion of mass, let us disclose the dimensional units of both the right-hand and left-hand sides of the Einstein's equation

$$\begin{aligned} W &= mc^2 ; \\ W &= [ \sum_{act} e^- \cdot E_E ] \cdot c^2 ; \\ [J] &= [Newton] \cdot c^2 ; \\ \left[ \frac{kg \cdot m^2}{sec^2} \right] &= \left[ \frac{kg \cdot m}{sec} \right] \cdot \left[ \frac{m^2}{sec^2} \right] \text{ [sic]} \\ \left[ \frac{kg \cdot m^2}{sec^2} \right] &= [0.102kg] \cdot \frac{m^2}{sec^2} = 1Newton = 0.102kg \\ [kg] &= [kg] \end{aligned}$$

Identity of both sides is achieved, but in the case of mass it is as a measure of acting charge  $\sum_{act} e^-$  interaction with a geoelectric field. Originally Einstein's equation lacked equality of left-hand and right-hand sides which made him assume that mass and energy are equivalent. While I showed to you that there is no such necessity if we accept my definition of mass. Thus we define mass in the only possible way as a measure of interaction between the acting electric charge of a material body and

the geoelectric field. I must stress here that no similar approach has ever been suggested in the available literature.

Taking the neutrino-to-electron mass ratio as an interaction measure with the geoelectric field let us proceed to the neutrino surface microcharge. Note that neutrino is an electron-positron pair.

$$m_\nu = e_{micro}^{+-} \cdot E_E = (e_{micro}^+ \cdot E_E) + (e_{micro}^- \cdot E_E) = e_{micro}^+ \cdot 2 \frac{e_E^+}{R_E^2}$$

$$e_{micro}^{+-} = \frac{m_\nu}{E_E} = 0.16 \cdot 10^{-42}, C \text{ [Coulombs]}$$

"+" and "-" microcharges of a neutrino interact both with another neutrino microcharge and the geoelectric field, thus producing in the first place neutrons and then, after coupling with a positron, protons. The attraction force between the coupled neutrinos that brings them together to form a neutron is equal:

$$F_{el.-pos.pair} = \left( \frac{e_{micro}^- \cdot e^+}{m_\nu \cdot m_\nu} \right) \cdot \frac{1}{r_{orb}^2} = 5.6 \cdot 10^{18}, N$$

Neutron is attracted to positron to form proton. Attraction force between them is

$$F_{n+e} = \left( \frac{e_n \cdot e^+}{m_n \cdot m_{e^+}} \right) \cdot \frac{1}{r_{orb}^2} = 7.5 \cdot 10^{27}, N$$

The geoelectric field should be expelling protons into the protonsphere. But it is not what happens during the formation of an atom. The terminal positron of a proton attracts only the electron that is decelerated by geoelectric field, thus preventing its adherence to the proton's positron. Attraction force between an

$$\text{orbital electron and proton's positron is } F_{orbit} = \left( \frac{e^- \cdot e^+}{m_{e^-} \cdot m_{e^+}} \right) \cdot \frac{1}{r_{at}^2} = 3.1 \cdot 10^{32}, N$$

Attraction force between proton/neutron pairs (p-n):

$$F_{p-n} = F_{el.-pos.pair} \cdot 2 \cdot 918 = 5.6 \cdot 10^{18} \cdot 2 \cdot 918 = 1.028 \cdot 10^{22}, N$$

Evaluation of forces participating in nuclear formation in an atom evidences that their nature is common - electric. An electronic coat covers the nucleus according to the charge conservation law [6]. It protects the nucleus from the direct interaction with the geoelectric field. A stable atom is born. The atom is electrically neutral but its nuclear charge and that of orbital electrons interact with geoelectric field in unlike fashion.

Following the removal of orbital electrons, the fields between the positrons of the nuclear protons and orbital electrons collapse. Emerged are the balanced, open-for-field effect, positrons of the nuclear protons. Driven by the geoelectric field, positrons escape from the protons that are coupled to neutrons (p-n). A proton without a positron decays together with its twin neutron. This is the native nuclear decay of every elemental atom. Nature-born native radioactive decay stems from weakly bound terminal electrons in atoms that need nothing more than the geoelectric field to be stripped off their orbits. It follows from Eqn. (1) that natural radioactivity is more a causal process than a spontaneous one. It is controlled by the continuous constant geoelectric field with strict correspondence of its nature to the physical essence of matter.

The radioactive nuclear decay described by Eqn. (1) is the specific case of the universal mechanism of transmutation of all material bodies in the Universe. By superposing an artificial  $E_{art}$  (V/m) field onto a geoelectric  $E_E$  one with simultaneous heating, we can control and accelerate nuclear decay of any element from the Periodic System by simply varying both values ( $E_{art}$  and  $E_E$ ) and the quantity of the supplied heat.

$$F = \sum_{act} e^{\cdot} (E_E + E_{art}) \tag{2}$$

Reproducible results of the experiments in a device constructed according to Eqn. (2) verified its validity. A variety of elements underwent decay, lead included, while being the finite product of thorium and uranium decay. New elements were detected that are placed to the left of lead in the Periodic System. We can suppose that the transmutation processes in our device are identical to the radioactive decay processes in the Earth's core.

Now let us model low-temperature nuclear decay, or transmutation (Fig. 3). The directional field  $E_{dir} = E_E + E_{art}$  and heat exposures start ionization of an atom; electron  $e^{-orb}$  escapes from its orbit, thus provoking collapse of the field between  $e^{+}$  positron of  $p_1$  proton and an orbital electron. Field-free positron  $e^{+}$  of proton  $p_1$  is separated from the nuclear proton due to  $E_{dir}$  force. The proton positron  $e^{+}$  couples with an orbital electron, and the proton that has lost its positron transmutes into an antiproton  $\bar{p}_1$ . The directional field  $E_{dir}$  induces further decay of antiproton  $\bar{p}_1$  to produce  $e^{-}$  electron and an electron-positron pair, that is neutrino  $\nu$ . The above antiproton transmutes further into a  $p_2$  proton open for interactions with  $E_{dir}$  field. Neutron  $n_1$  and proton  $p_1$  in the nucleus form a couple (p-n). Therefore,  $\bar{p}_1$  antiproton decay involves  $n_1$  neutron decay accompanied by isolating both  $e^{+}$  positron as a twin to  $e^{-}$  electron from  $\bar{p}_1$  antiproton and  $\nu \downarrow$  neutrino as a twin to  $\nu \uparrow$  antineutrino. Neutron  $n_1$  transmutes into  $\bar{n}_1$  antineutron, and antiproton  $\bar{p}_1$  -- into  $p_2$  proton. Transmutation proceeds further on in like manner: antineutron  $\bar{n}_1$  transmutes into  $n_2$  neutron, and proton  $p_2$  -- into antiproton  $\bar{p}_2$ . Thus, the nuclear decay results in the following couples: antiproton-proton ( $\bar{p}_1 - p_1$ ), antineutron-neutron ( $\bar{n}_1 - n_1$ ), antineutrino neutrino ( $\nu \uparrow - \nu \downarrow$ ), and an electron  $e^{-}$  [7-10].

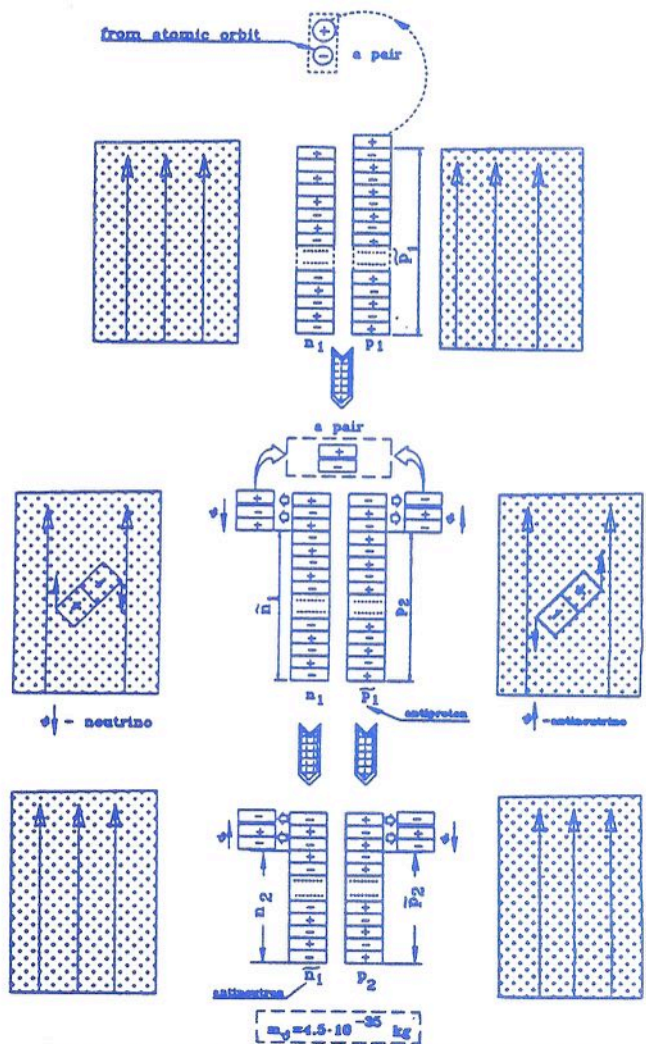

Fig. 3 MODEL OF PROTON AND NEUTRON TRANSMUTATION

Obtained speculative sequence of the nucleons' decay into antinucleons is valid and can be verified by the results from sophisticated hot-fusion accelerators in the U.S. as far back as 1955 and 1956 when antiprotons and antineutrons were received [7]. Antinucleons are of principal interest for us due to their interaction with nucleons. When antinucleons  $\bar{p}_i, \bar{n}_i$  and nucleons  $p_i, n_i$  meet, huge energy is liberated

$$W = 2m_N \cdot c^2 = 2\sum_{act} e^- \cdot E_R \cdot c^2 = 2.81 \cdot 10^8 \cdot \sum_{act} e^- \cdot c^2 = 1900, \text{ MeV.}$$

Irreproducible or scarcely reproducible experiments with cold fusion cells evidence at least two facts: first, continuously active natural forces are not taken into account; second, electrolytes and cell elements react to these forces.

Both electric fields and energy induce transmutation that expands (or becomes more advanced) when the artificial electric field  $E_{art}$  is backed by the geoelectric field  $E_R$ . Transmutation slows down when they are uncoupled. Change of polarity sign in the cold fusion cells entails the related change in the direction of acting forces. [sic - We are not aware of what is meant by change of polarity. We assume it means "if one changes the polarity." --Ed.]

The above concepts enable us to suggest that all phenomena in the electrochemical cells associated with Pons and Fleischmann, and in the wide range of their diverse constructions, are nothing else than the outcome of low-temperature transmutation. Neutrino, nucleus, atom - these are three inseparable constituents of a single whole, the Holy Trinity that is God Himself.

I hope to have introduced by my theoretical study a fresh understanding of cold fusion as an essentially natural cold fission, a mere stage in the universal transmutation.

Thank you.

#### LAST MINUTE CONSIDERATIONS

In the isolated system, the net electric charge, i.e. algebraic sum of the positive and negative charges, stays constant. An isolated system is a system whose boundaries are impenetrable for any other substance. The net charge of the isolated system (atom) is a quantity that never changes.

The charge conservation law would be violated if a positively charged particle is created without simultaneous creation of a negatively charged one. The event is never observed. The charged particles are born in pairs, with equal and opposite charges. This absolute equality of charges, as well as equality of masses, displays some universal symmetry of nature inherent in particle and antiparticle [6].

It appears that conservation of charge results from some more general conservation law that governs the emergence and decay of particles.

It must be more probable, that conservation of the net charge in the isolated system is the primary requirement which all other laws obey. Here is a valid substantiation: the transmutation mechanism in the Earth's core gives birth to all the elements of the Periodic System - this is the basis of the universe having all the forces to support transmutation. Its mechanism is actuated into continuous operation by the never-violated conservation law: the net charge of an isolated system being the primary requirement that transmutation obeys. Hence, transmutation is the all-embracing process in the universe that proceeds eternally, differing in time and in objects.

Transmutation is present in the cold fusion cells too, but as a low temperature transmutation and not fusion. Artificial violation ionization, stripping of orbital electrons of the net electric charge in the isolated system results in the immediate, accelerated and controllable nucleus transmutation. It leads to restoring the conservation law by the compulsory formation of a new element that is placed in the Periodic System higher than the decaying one. Continuous transmutation of all materials proceeds in the universe with different rates. These rates can be controlled by artificial means.

## REFERENCES

1. E.F. Mallove and J. Rothwell, *Cold Fusion*, May 1994, vol 1, no 1, p 51.
2. L. Kervran, *Transformation l'Energie du Faibles*, Paris: Malon, 1975, 150 pp.  
L. Kervran, *Prenvens en Biologie de Transmutation a Faibles Energies*, Paris: Malon, 1975, 210 pp.
3. A.K. Barnard, *Theoretical Basis of Inorganic Chemistry*, Moscow: Mir Pub., 1968, in Russian.
4. K.V. Ovchinnikov, S.A. Shchukarev, *Electrons in Atoms*, Moscow: Khimia Pub., 1970, in Russian.
5. E.N. Velikhov, *Science and Life*, 1987, no 11, in Russian.
6. E.M. Purcell, *Berkely Physics Course, V.2, Electricity and Magnetism*, Moscow: Nauka Pub., 1967, in Russian.  
Max Jammer, *Concepts of Mass in Classical and Modern Physics*, Moscow: Progress Pub., 1967, in Russian.
7. Jay Orear, *Physics, V.2*, Moscow: Mir Pub., 1981, in Russian.
8. Isaac Asimov, *The Neutrino - Ghost Particle of the Atom*, Moscow: Atomizdat Pub., 1969, in Russian.
9. W. Greiner, A. Sandulescu, *Sci. Amer.*, 1990, nol 262, no 3.
10. K. Mukhin, *Introduction to Nuclear Physics*, Moscow: Atomizdat Pub., 1965, in Russian.

Table 2

Groups of Elements							
Period	Row	0	I	VII	VIII		
1	I	v 45.696 · 10 <sup>-50</sup>	H 1 14.03 · 10 <sup>-26</sup>	H 2 27.57 · 10 <sup>-26</sup>			
2	II	He 2 32.503 · 10 <sup>-26</sup>	Li 3 39.0 · 10 <sup>-26</sup>	F 9 148.986 · 10 <sup>-26</sup>			
3	III	Ne 10 170.136 · 10 <sup>-26</sup>	Na 11 210.487 · 10 <sup>-26</sup>	Cl 17 324.751 · 10 <sup>-26</sup>			
4	IV	Ar 18 342.252 · 10 <sup>-26</sup>	K 19 382.488 · 10 <sup>-26</sup>	Mn 25 509.313 · 10 <sup>-26</sup>	Fe 26 523.445 · 10 <sup>-26</sup>	Co 27 546.86 · 10 <sup>-26</sup>	Ni 28 574.16 · 10 <sup>-26</sup>
	V		Cu 29 587.47 · 10 <sup>-26</sup>	Br 35 707.017 · 10 <sup>-26</sup>			
5	VI	Kr 36 733.897 · 10 <sup>-26</sup>	Rb 37 839.08 · 10 <sup>-26</sup>	Tc 43 979.6 · 10 <sup>-26</sup>	Ru 44 1006.5 · 10 <sup>-26</sup>	Rh 45 1028.5 · 10 <sup>-26</sup>	Pd 46 1050.0 · 10 <sup>-26</sup>
	VII		Ag 47 1074.8 · 10 <sup>-26</sup>	I 53 1191.2 · 10 <sup>-26</sup>			
6	VIII	Xe 54 1210.65 · 10 <sup>-26</sup>	Cs 55 1218.7 · 10 <sup>-26</sup>	Re 75 1645.23 · 10 <sup>-26</sup>	Os 76 1664.71 · 10 <sup>-26</sup>	Ir 77 1680.5 · 10 <sup>-26</sup>	Pt 78 1690.0 · 10 <sup>-26</sup>
	IX		Au 79 1734.65 · 10 <sup>-26</sup>	At 85 1785.1 · 10 <sup>-26</sup>	Rn 86 1793.15 · 10 <sup>-26</sup>		
7	X		Fr 87 1840.21 · 10 <sup>-26</sup>				

# The Web of Life from Soil to Humanity and the Role of Ancient Mineral Deposits in Agriculture, Animal and Human Nutrition and Medicine

by Timothy A Binder

## A to Z of Minerals = Azomite & Seaweeds

The following article relates my personal experiences with a colloidal silicate clay montmorillonite mineral deposit and other mineral deposits that I feel are important in maintaining healthy soils and plants and the human and other animals that live on them. This knowledge is important for humanity's survival and vitality.

### Humanity's Experiment with Chemically Fertilized/Poisoned Soils/Foods

I will describe humanity's experiment with chemical farming the last 100 some years very simply as follows: Analysis was attempted to determine what plant life essentially consisted of and was erroneously simplified by recognizing the macrominerals nitrogen, phosphorus and potassium while ignoring the trace minerals. Agriculturists were able to produce a temporary increase in yields (quantity) and overlooked or were unaware of the decrease in quality. As the plant quality declined pests became more abundant. I suggest that the function of plant pests as well as the function of "germ" pests in animals and humans is to get rid of unhealthy plant, animal or human life. In this sense the germs and the bugs are scavengers, garbage cleaners and undertakers - the hit men of the biological world. Dr. Albrecht at the University of Missouri in the 1930's demonstrated this in plants. He had a row of good mineralized soil with no bugs right next to a row of demineralized unhealthy soil that was producing sickly plants and a profusion of bugs. While I do not presently have exact references to cite of his work it is available in various editions of the 1930's yearbooks of the US Department of Agriculture. I have a 1938 yearbook with some of this info in it.

The idea that we need to have NPK fertilizers and especially nitrogen is so pervasive that even with all the progress made in awareness of the benefits and superior quality of organic agriculture practices, our scientific journals still feature articles that miss the points I am making in this article about the importance, need and place of broad trace mineral rich rock dust soil conditioners in producing quality poison free food in quantities needed to sustain our world population. The July 1994 issue of *Scientific American* has an article titled *Global Population and the Nitrogen Cycle* by Vaclav Smil that talks about traditional practices that used green manure crops and other means to add nitrogen, phosphorus and potassium to the soil, but claims these are not enough to sustain our population and we must use the synthetic nitrogens to produce enough quantity of food protein. There is no mention or apparently any awareness of how NPK fertilizers progressively reduce the trace minerals although he does mention adverse effects such as poisoning soils and waters through nitrogen buildup. Nor is there any mention of how rock dusts sustain the soils nor experiences/experiments such as those of the people of Hunza. My guess is that no awareness of transmutation and how transmutation is part of Universal Processes is the



root of this lack of awareness. Back of this is unawareness of how Universe works. It is ignorance of fundamental comprehensive generalized knowledge like that taught through the University Of Science and Philosophy.

By adding NPK fertilizers ( nitrogen phosphorus and potassium) to our soils we have used up the trace minerals and the soils are becoming non-productive as well as producing unhealthy offspring. The addition of chemical pesticides and herbicides does not correct the underlying mineral deficiencies and adds a toxic burden in addition. These chemicals enter the plants and the animals and humans that consume them. We witness the results in a profusion of degenerative diseases, increasing sterility and social disintegration in poisoned and sickly plant and animal life.

### **Solutions/Alternatives**

A solution to this problem is to remineralize our soils and cease the use of the toxic pesticides and herbicides. This is where the use of *Azomite* and other mineral deposit soil conditioners can play a role in restoring health and vitality to our soils, plants, animals and humanity.

In the latter 1800's a German I believe named Julius Herschel penned a book titled *Bread From Stones*. He demonstrated that ground rock dusts added to the soils were sufficient to keep them productive. His work was allegedly vigorously attacked by the fertilizer companies who were already making money from the sale of NPK.

The Hunzas in a small kingdom near Kasmir and Tibet are legendary for their health and longevity. They live in a tiny mountain valley and eat very little animal foods and have little to no fertilizers or human or animal manures that are used on their fields. They have kept their fields productive for a thousand years by simply flooding them twice a year with rock

dust laden water from the glacier above the valley that is filled with glacial silt. They have accomplished a thousand year scientific experiment for us demonstrating the simple method that we can imitate to produce healthy soils, plants, animals and people. Simply add ground rock dusts and especially silicate rock dusts to the soils.

Silica appears to play a special role in the soil as the Russell's pointed out somewhere in their works. I am unaware of the special place of silica. Are any of you aware of its actions that merit this claim?

John Tobe and Joseph Rodale both wrote books about their travels to Hunza. Mr. Tobe related that he observed at the meals he ate with the Mir, the "king" of Hunza, that they all were drinking this grey milky colored water while his was clear. He asked them why the difference and was told they preferred to drink the glacial silt laden waters but thought he would prefer clear water. He informed them otherwise and proceeded to drink the vital life enhancing mineral rich waters with them.

### **The Whole Cycle of Nature**

How do minerals produce this effect on soils or how can we get bread from stones? The answer lies in understanding the whole cycle of nature which is as follows: There are microorganisms (bacteria) in the soils that transform/transmute (eat) the rocks. The plants then eat the bacteria or their roots sidle up to the soil's bugs and suck the protoplasm from their bodies. The animals and humans then eat the plants and other animals that eat the plants that eat the bugs that eat the rocks. The plant and animal (and the microorganisms ) bodies all return to the soils to be part of the recycling/transmutation/transformation processes. Micro-organisms in our gastrointestinal tracts may play a similar role in transforming non chelated colloidal minerals into protein bound chelates so that we may

absorb and use them in our bodies. They may also engineer transmutations of elements up and down the octaves including transmutation of radioactive elements into non-radioactive elements.

If the rocks are in a colloidal form they are available for the soil bacteria just as they are in this form available for our G.I. tract bacteria. So, a one pound rock in the ground provides a relatively small surface area for the bacteria to eat from, whereas this same rock ground into fine colloidal size rock dust powder makes the entire rock available right now as soil bacteria food.

*Azomite* contains roughly the same minerals that are available in seaweeds and in similar proportions but it is almost wholly mineral matter – about 98% mineral matter and 2% organic (plant body fiber) matter. Seaweeds are about 2% mineral matter and 98% organic matter. In this sense I can say that two pounds of *Azomite* contains the mineral equivalent of about one hundred pounds of seaweeds. It is lacking in the iodine that seaweeds have as it has been leached out by iodine's easy water solubility. For this reason I advocate the eating of some seaweed even if you eat *Azomite* or other mineral deposits that might not contain iodine.

It appears that a broad mix of trace minerals are necessary for healthy micro-organisms, plants and animals to thrive. The role that transmutation plays in this scenario is largely unknown to me at this time. There are suggestions in the works of Louis Kervran. G. Rabzi's paper in this issue has suggestions for how all elements are created/transmuted throughout the earth's core and surface. Of course Russell's work has suggestions too but no one I'm aware of has revealed anything but a skeleton key that will unlock the secrets of any and all transmutation processes in nature. All the steps are yet unknown.

There is evidence from Dr. Albrecht's work and contemporary human nutritional studies that trace minerals are the "cures" for many diseases. Selenium which in Russell's *Cosmogony* is a harmonic of oxygen (and it is a harmonic of sulfur as sulfur is a harmonic of oxygen) is touted as being an "anti-oxidant" mineral and essential in the prevention of cancer. Ditto for the trace mineral cobalt that forms the base of vitamin B-12 and thus prevents and cures pernicious anemia. I have found the trace mineral vanadium to be a cure for many cases of oedema and especially swellings or water retention in the lower legs. Vanadium is also an oxygen carrier or catalyst and helps fight infectious diseases as the free oxygen radical is the rascal that destroys viruses and bacteria via the white blood cells. I conceive of an anti-oxidant like selenium as being a substance that facilitates the use of oxygen by the body in any of its forms, free or bound. Sulfur has oxidizing properties and I suspect that selenium does too and they may be super-oxidizing properties as older stages of the idea/form of oxygen.

### *Azomite* Stories

With the preceding as background I will now relate some personal experiences and stories about the *Azomite* deposit and what it can do.

I first became aware of *Azomite* in the late 1960's and attempted to sell it to farmers in Colorado with no success. They were so enamored with chemical farming that I could not get them to listen. But, there were those who were listening and one of these was the Clover Club potato chip company who had experimented with it and found it to be phenomenal. They did not want the competition to know of this secret to incredibly good tasting potatoes and high yield but finally consented to let the *Azomite* company tell its story as an inducement for others to try it. Clover Club found that with a 600 # per acre application they got a 92% increase in yield. For every dollar

invested they got back \$1,333!

When I was attending Chiropractic and Naturopathic colleges in Portland Oregon I met a farmer through friends at a health food store who was desperate to try something to save his farm. The year before I met him the cannery did not want his berries, because they were so puny and poor in quality. On 21 acres of berries he had about a 70 ton harvest. I had him put down 400 pounds per acre directly in the row as it will not burn the plants as nitrogen fertilizers do. That year he got a 140 ton yield, doubled it, and the berries were the sweetest tasting most delicious berries you could ever get. I am including pictures of these berries and some from an adjacent comparative test field that were not *azomited* so you can visually appreciate the difference. The *Azomite* berries of course are the larger, juicier, more delicious berries.

From the investigations I did I found this *Azomite* deposit had more trace elements and in greater quantities than any others I was aware of. It has approximately 100 to 1000 times the amounts of trace elements that other deposits have. While this appears to be the case it also appears that almost any mineral deposits would help our demineralized soils and thus plant and animal foods raised on them and thus humanity.

I knew the man who discovered the deposit, his name was Rollin Anderson. I last talked to Rollin about 8 years ago and he was about 95 years old at the time. He told me that of the around forty some people who were aware of his discovery about 40 years ago at that time, that half of these people were still alive and the other half had died. The half that were still alive had been eating the *Azomite* ground into a powder daily and the other dead half had stopped eating it some many years ago. The oldest living member of the group at that time he said was a 104 year old lady! I have eaten

this mineral off and on for years and do now daily. I have raised two children who ate it frequently and they have yet to have a cavity at ages 26 and 30.

## Other Mineral Sources

In lieu of being able to eat foods grown on any highly mineralized, let alone *Azomite* mineralized soils, I recommend that people eat some source of colloidal minerals, several of which I will recommend. I feel the *Azomite* is a preferred source over those sources that are not fossilized plant and animal sea creatures but simply ground or dissolved rock deposits of various sources because I intuit that having been through the "organic" life process as ancient sea plant and fish creatures endows *Azomite* with a greater availability to becoming absorbed into our bodies than just ground or dissolved rock deposits.

The source should be in colloidal form meaning small enough to not settle out in a solution so that it can be absorbed into our bloodstreams after being bound or chelated to proteins in our G.I. tracts. Some part of any ground rock deposits will be in colloidal form but the more and finer the grinding the more that will be in colloidal form. Virtually all of dissolved rock springs waters will be colloidal.

## Other Sources

There are several different brand names of and/or sources of *Clark's Original Mineral Formula* that are being marketed including "Body Toddy" and other names. I first became aware of this mineral source when in Chiropractic college under the name of "vitaminerals 120" and have seen it called "Minrasol" "Golden Nectar" and other names. It will be recognized by its distinctive very sour taste and amber or golden brown color and it is a liquid. It comes from a Utah mineral springs that emanates from water that apparently has been trapped in underground rock

pocket formations for millions of years. It is obviously colloidal. This is the best remedy for burns I know of. If you cover a burn with cotton soaked in the solution and cover it with plastic and close it with tape so that it does not evaporate it will remove the pain of a burn within about twenty minutes. I have used it to heal horrible third degree burns with no residual scarring. I have not used the *azomite* yet, but it has occurred to me that the powder wetted and plastered on and covered with plastic to keep it moist might work as well as the "Clarks" mineral waters.

*Clod Buster* is a Texas mineral source that has helped farmers remineralize their soils and there were some dolomite deposits from Nevada and Colorado that I know have proven useful as well. But none of these appeared to have the broad trace mineral content, quantities

and power of *Azomite*.

The most easily available mineral source for people to get is seaweeds. The addition of several kelp tablets to your daily diet or any of the many seaweeds can be used in soups or in other dishes as a good source for the missing trace elements in our depleted soils and thus depleted foods. Seaweeds also have been through the organic life process and most of the minerals will be chelated or bound to the plant proteins for easy absorption.

Ordering information and prices for *Azomite* and *Clark's Original Mineral Formula* can be obtained by writing or calling Health Yourself / Binder Educational Services, 173 Blodgett Camp Rd., Hamilton, MT 59840 or call 406-363-4041.

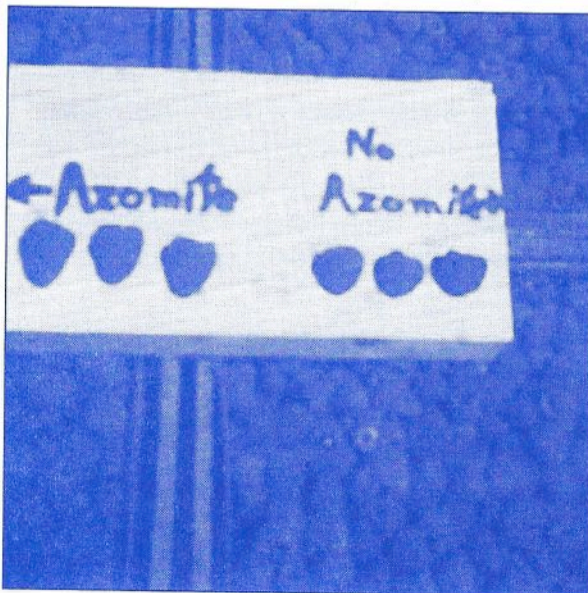

# AZOMITE

ALL NATURAL MONTMORILLONITIC COLLOIDAL SILICATE MINERALS

and

TRACE ELEMENT CATALYSTS

with

ION EXCHANGE FACTORS

IN THEIR NATURAL SYNERGISTIC RELATIONSHIP

NONSWELLING

NONTOXIC

## COMPREHENSIVE ANALYSIS

ELEMENT	SYM-BOL	AT. NO.	Energy Potential Atomic Weight	Ion Exchange + Cation - Anion	Valence	Nature	Element Classed As	Element As Plant Nutrient	Element As Animal Nutrient	Percentage Of Total As Oxides
HYDROGEN	H	1	1.008	+	1	Gaseous	Primary	1**	3****	.1936*
LITHIUM	Li	3	6.940	+	1	Metallic	Trace	2***	4*****	Trace
BORON	B	5	10.82	+	3	Nonmetal	Trace	1	4	.007
CARBON	C	6	12.01	- +	2-3-4	Nonmetal	Primary	1	3	.63
NITROGEN	N	7	14.008	- +	3-5	Gaseous	Primary	1	3	1.88
OXYGEN	O	8	16.00	-	2	Gaseous	Primary	1	3	1.5364*
FLUORINE	F	9	19.00	-	1	Gaseous	Trace	2	3	.02
SODIUM	Na	11	22.997	+	1	Metallic	Secondary	2	3	2.74
MAGNESIUM	Mg	12	24.32	+	2	Metallic	Secondary	1	3	.71
ALUMINUM	Al	13	26.97	+	3	Metallic	Trace	2	4	13.99
SILICON	Si	14	28.06	+	4	Nonmetal	Trace	2	4	66.08
PHOSPHORUS	P	15	30.98	- +	3-5	Nonmetal	Primary	1	3	.058
SULPHUR	S	16	32.066	- +	2-4-6	Nonmetal	Secondary	1	3	.06
CHLORINE	Cl	17	35.457	-	1-3-4-5-7	Gaseous	Secondary	1	3	.20
POTASSIUM	K	19	39.096	+	1	Metallic	Secondary	1	3	2.75
CALCIUM	Ca	20	40.08	+	2	Metallic	Secondary	1	3	3.68
TITANIUM	Ti	22	47.90	+	3-4	Metallic	Trace	2	4	.08
VANADIUM	V	23	50.95	+	2-3-4-5	Metallic	Trace	2	4	Trace
CHROMIUM	Cr	24	52.01	+	2-3-6	Metallic	Trace	2	4	.01
MANGANESE	Mn	25	54.93	+	2-3-4-6-7	Metallic	Trace	1	3	.09
IRON	Fe	26	55.85	+	2-3	Metallic	Secondary	1	3	1.72
COBALT	Co	27	58.94	+	2-3	Metallic	Trace	2	3	Trace
NICKEL	Ni	28	58.69	+	2-3	Metallic	Trace	2	3	Trace
COPPER	Cu	29	63.57	+	1-2	Metallic	Trace	1	3	.01
ZINC	Zn	30	65.38	+	2	Metallic	Trace	1	3	Trace
GALLIUM	Ga	31	69.72	+	2-3	Metallic	Trace	2		Trace
ARSENIC	As	33	74.91	+	3-5	Nonmetal	Trace	2	3	1ppm
STRONTIUM	Sr	38	87.63	+	2	Metallic	Trace	2	4	.025
ZIRCONIUM	Zr	40	91.22	+	4	Metallic	Trace	2	4	.02
MOLYBDENUM	Mo.	42	95.95	+	3-4-5-6	Metallic	Trace	1		Trace
SILVER	Ag	47	107.880	+	1	Metallic	Trace	2	4	Trace
TIN	Sn	50	118.70	+	2-4	Metallic	Trace	2	4	Trace
BARIUM	Ba	56	137.36	+	2	Metallic	Trace	2	4	.025
LEAD	Pb	82	207.21	+	2-4	Metallic	Trace	2	4	.004
ORGANIC MATTER										2.63
TOTAL PCT.										<u>99.1490</u>

\*Moisture shown as Hydrogen - Oxygen

Combined Energy-Potential or Atomic Weight of each Atom Present in the Elements of the whole

1858.606

1.73

- \*\* 1 Element established as an essential plant nutrient.
- \*\*\* 2 Element identified in plants but not established as essential.
- \*\*\*\* 3 Element established as an essential animal nutrient.
- \*\*\*\*\* 4 Element identified in animal tissue but not established as essential.

—Source of Data: U. S. D. A.

The major part of all living tissue and the food assimilated by plant and animal consists of material in the colloidal state.

“CATALYST” is a word coined by the great Swedish chemist Berzelius to describe substances that speed up chemical reactions, but which come through these reactions themselves unchanged.

“Emphasis on soil colloids (especially the fine clay) stimulated by Milton Whitney led to the discovery that clays are crystalline. Knowledge about the properties of these clay mineral systems has become a cornerstone of modern soil science.”

—U. S. Department of Agriculture Yearbook, 1957, page 8

Colloids are often gelatinous in fine subdivision or dispersion permeable by crystalloid solutions, and not at all or very slightly diffusible through animal or vegetable membranes. “In general, colloids with a relatively high silica content are better able to hold plant nutrients than those low in silica.”

—U. S. Department of Agriculture Yearbook, 1938, page 40.

“Cation exchange is an important consideration not only in respect to nutrients already present in soils but also in relation to those applied in commercial fertilizers and in other ways. It is no wonder that cation exchange, next to photosynthesis, is said to be “the most important chemical reaction in the whole domain of agriculture.”

—Colloids in Agriculture, by C. E. Marshall, page 79.

“ONE BY ONE, new elements have been added to the list of those known to be necessary for plant growth and health. Some of these elements are needed in only a few parts per million of soil; yet without this trace, plants — and animals also — suffer from serious diseases. This is one of the most interesting fields of modern research in plant and animal nutrition.”

—U. S. Department of Agriculture Yearbook, 1938, page 807.

“Valence” indicates the combining capacity of the atoms or groups of atoms in the elements (or radical) as shown above.

NOTE — Being a natural product, analysis may vary. The above analysis is based upon the report of findings, Laboratory No. 1115, as made by the Dijkers Biochemical Laboratory, Los Angeles.

# AZOMITE\*

## **A Natural Composition of Colloidal Silicate Minerals and Trace Element Catalysts with Ion Exchange Factors all in their Natural Synergistic Relationship.**

---

**Colloidal Silicate Minerals** or clay mineral systems are Nature's storehouse for the largest group of chemical elements in the mineral kingdom.

**Colloidal** is a condition and not a kind of mineral; the fine dust-like mineral particles pass into the colloidal state or minute degree of fineness upon reaching a critical particle size when their activity prevents them from settling out as molecules of their particular inorganic element. Particles larger than one micron are generally regarded as outside the colloidal range. Mineral elements in a colloidal state are largely in an available condition ready for immediate utilization by plant and animal life.

**Trace Elements** – the basic word is elements, all of them used by Nature in trace or minute quantities. Webster defines "trace element" as a chemical element used by organisms in minute quantities and held essential to their physiology – a branch of biology dealing with organic processes, activities, and phenomena incidental to an organism or any of its parts, and characteristic of life or of living matter.

The role of trace elements is catalytic, although not necessarily exclusively so. They play a most important part in many organic processes which they help to regulate when present in quantities as small as parts per million or parts per billion; e.g. copper is reported to be effective in plant life when present in a concentration as low as one part per 10 million (dry matter); molybdenum is effective when present in one part per 200 million, and cobalt is effective when present in one part per billion.

While the quantity of any one element may be small and effective, compared to another, no element functions alone, but only in conjunction with others equally as important.

**Montmorillonitic** (2:1 lattice type) identifies the more extensive electrically charged surface areas or greater points of contact in aqueous solutions, by virtue of the minute particle sizes characteristic of the particular colloidal structure. These distinguish them from the lesser ionic exchange capacity group (1:1 lattice type) of silicate mineral compounds.

**Ion Exchange Factors** are associated with the electrical phenomena of growth. All organic activities and processes of growth in any living organism, or any metabolic function associated with sustaining life of any kind, requires elements of ion exchange. *Cations* (+) carrying a positive electrical charge, and *anions* (-) having a negative potential are constituents of acids, bases, and salts that become active as electrolytes (conductors) in aqueous solutions. Thus, life in its broadest sense is electrical – derived from chemical elements.

Obviously, as the list of essential mineral elements continues to increase, the significance of **The Architect of The Universe** forming man (*Gen. 2:7*), and animals, and fowl (*Gen. 2:19*) out of the apparent dust-like mineral particles of the ground or earth – long forgotten or ignored – will have a more profound meaning as scientists advance in their studies and research in biology, the science of living things; cytology, dealing with the structure and function of cells; and histology, dealing with the minute structure of plant and animal tissues.

As **The Good Book** states (*Eccl. 1:9*): "There is no new thing under the sun." It is only the discovery that makes it seem new.

**Nontoxic**, as the word implies, are elements in quantities that do not exceed the tolerance level and safety index established by scientific research. As far as is known, the danger of elements exceeding tolerance levels is remote in the natural nonswelling montmorillonitic type of colloidal silicate mineral compounds.

**Nonswelling** permits the free action of colloidal silicate elements to function efficiently with the elements of the atmosphere in the aqueous solutions of the soil, or plant or animal life.

**The Synergistic** – *working together* – relationship and mineral inter-relationships between trace elements and other nutrients is helping to develop new concepts of the function and vital importance of trace elements, which at one time were regarded as contaminants and were not studied with any great interest until recently.

---

# AZOMITE

A Product of  
AZOME UTAH MINING CO.

## Luminon - Does Increased Lamp Efficiency Utilize An Element Predicted by Walter Russell?

Wireless Engineering, Inc. has been investigating the use of switching circuits that provide better conversion of electrical energy to light by using Spectral Amplitude Shifting circuitry in gas discharge lamps. Current research has centered around the use of a Spectral Amplitude switching circuit that nearly doubles the light output from mercury vapor lamps while doubling efficiency. The chart below (Fig. 1.) indicates the effect that this circuit has on lamp operation.

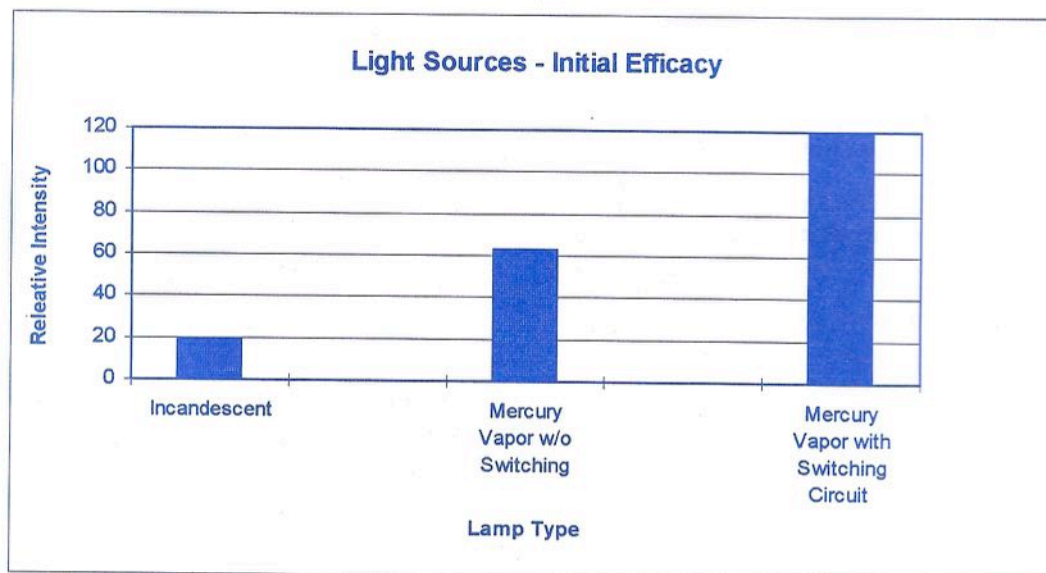

Figure 1. Effect of switching circuit on mercury vapor lamp. Output of standard incandescent is shown for comparison of relative intensity.

### 1. OVERALL BACK GROUND AND TECHNICAL APPROACH

Two methods have been used to reduce the energy consumption of gas discharge lamps. These are refinements in lamp design and new methods of providing ballasts for the lamps. Using techniques such as voltage control, pulse width modulation, and electronic switching circuits, designers have greatly improved the efficiency and performance of lighting systems.

Wireless Engineering has recently experimented with circuits and frequencies that cause a spectral shift and an increase in the light output from a gas discharge lamp. The graphs in Figure 2 and Figure 3 show data from tests performed during the last year.

The tests of conventional gas discharge use a passive circuit element as a ballast. The lamp intensity vs. power is shown in Figure 2 as the curve marked  $\Delta$ -ballast. As expected, when the voltage across the lamps under test is increased, the light output increases linearly as power dissipation increases. This effect is shows the linear relationship between power supplied to the



lamp and the resulting relative lamp intensity. This mode of operation allows an increase or decrease of lamp output by varying the voltage to the lamps in a manner similar to standard lamp dimming systems.

### LAMP INTENSITY vs. TUNING & CONVENTIONAL BALLST

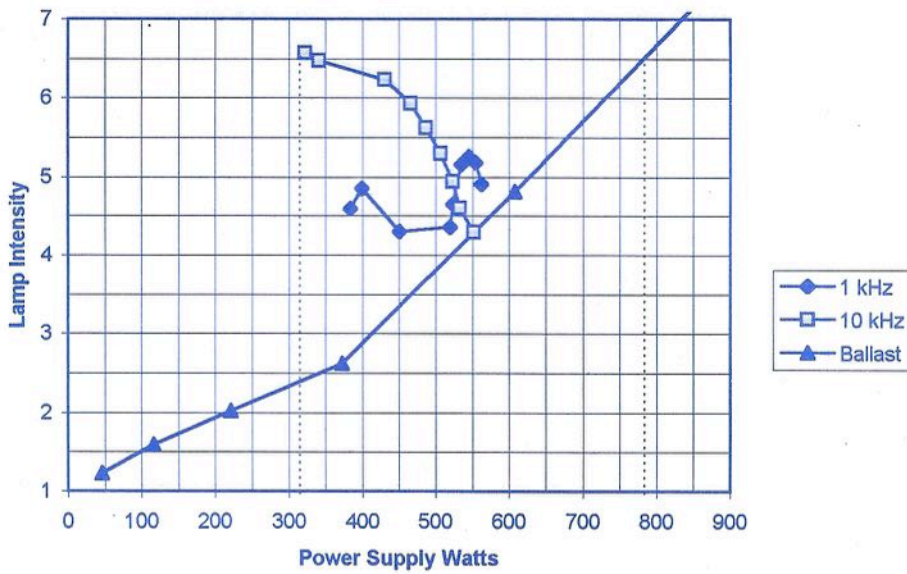

Figure 2. Plot of Lamp Intensity vs. Power using standard ballast as compared to Intensity vs. Power using a specially developed Switching Circuit operated at 1 kHz and 10 kHz.

When the lamps are used with a circuit that causes Spectral Amplitude Shifting, the lamps may be operated at a point where the power required to produce a given light output is almost half of that used when operated with the standard ballast. The curves of data taken at 1 kHz and 10 kHz are also plotted in Figure 2 and illustrate this point. The curve of operation at 10 kHz reaches a maximum value at a power consumption of 320 watts. The standard ballast circuitry requires 2.4 times more power to achieve the same lamp intensity.

### Use of a Switching Circuit to Control Spectral Amplitude Shifts and Increase Lamp Intensity

The switching circuit that was used to produce spectral changes can be operated over a continuous range from 0 to 16 kHz. In addition, the circuit topology can be varied at each frequency allowing the circuit to be tuned for maximum lamp intensity. The Circuit Tuning is adjustable within a range from 20 to 100 percent. As presented here, the Circuit Tuning can be considered as a measure of switching circuit tuning. As shown by the data in Figure 3, maximum lamp intensity is obtained when the switching circuit is tuned between 20 to 30 percent.

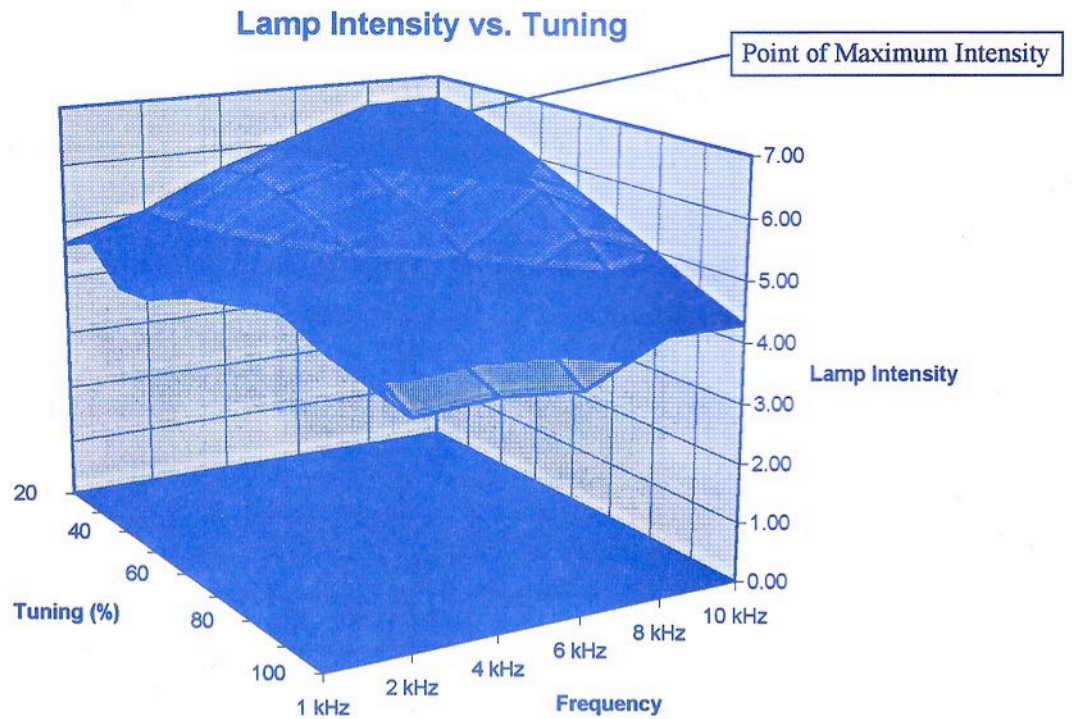

Figure 3. Plot of Lamp Intensity vs. Tuning using a specially developed Switching Circuit.

The plot of Lamp Intensity vs. Circuit Tuning (Figure 4) shows the range of control over which the tuning circuit can operate. When the circuit is tuned to 20%, the lamp intensity is maximum and the power is minimum.

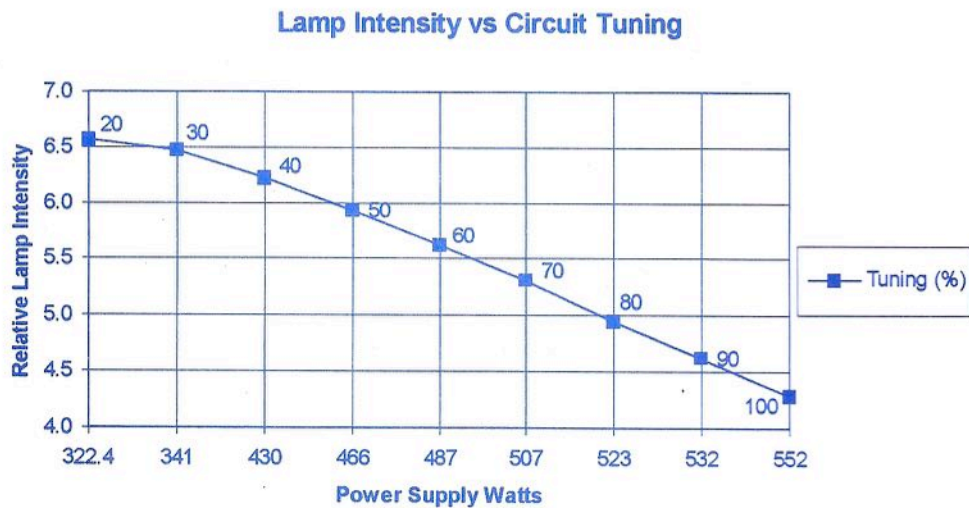

Figure 4. Lamp Intensity vs. Circuit Tuning at 10 kHz. The lamp intensity is at a maximum value when the Circuit Tuning is set to 20 percent. At this point of operation the lamp consumes half the power that a conventional ballast would use.

The point of maximum power expenditure is obtained when the circuit is operating with only a conventional ballast. These measurements and this curve are in direct contradiction of the results of measurements made by previous investigators using only conventional or electronic ballasts.

#### The Effect of Spectral Amplitude Shifting on Lamp Temperature.

A plot of data collected while the circuit was tuned over a range from 20 to 100% shows a drop in temperature as the circuit is tuned from 50 to 20 percent. This is of significance because the

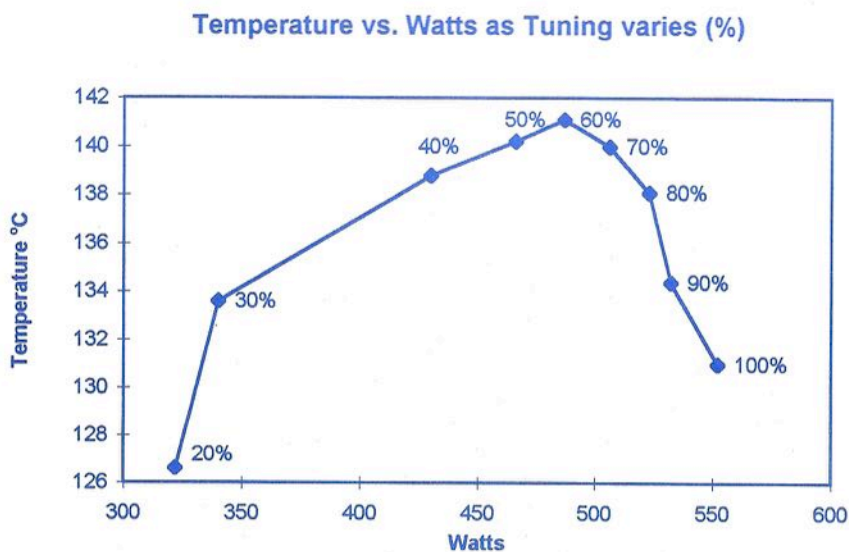

Figure 5. The temperature curve at 10 kHz as the switching circuit was tuned from 20 to 100%.

maximum brightness occurs near 20% yet the bulb temperature is at the coolest point of operation during maximum brightness and minimum power consumption. In other words, the temperature of the bulb when the lamp is consuming half the power but producing more luminous output, is cooler than a bulb operated with a standard ballast. The lamp appears whiter and brighter to the eye when operated under these conditions.

**Luminon** was an element predicted and shown by Walter Russell on his periodic chart of the elements. This gas was predicted, as the name implies, to be useful in lighting applications. Is it possible that there are transmutation byproducts occurring during the circuit operation that include the production of Luminon? The next phase of research to be conducted on the Spectral Amplitude Shifting effect will include the use of Quadrapole Mass Spectrometry to determine what elements are present in the discharge during lamp operation.

## 2. COMMERCIAL POTENTIAL

A full analysis of the output spectrum from the lamps under test has been made to verify the spectral shift. Spectral analysis plots of the lamp output at 30% tuning and at 90% tuning follows this text which shows the increased spectral output corresponding to increased efficiency.

The commercial potential of this research applies to the Gas Discharge Ballast Market. At this stage of research, the available market consists of mercury vapor high intensity discharge lighting (HID). The World Ballast Lamp Market is shown in Figure 6. The potential application for spectrum shifting for increased lighting efficiency includes lamps displayed in the graph.

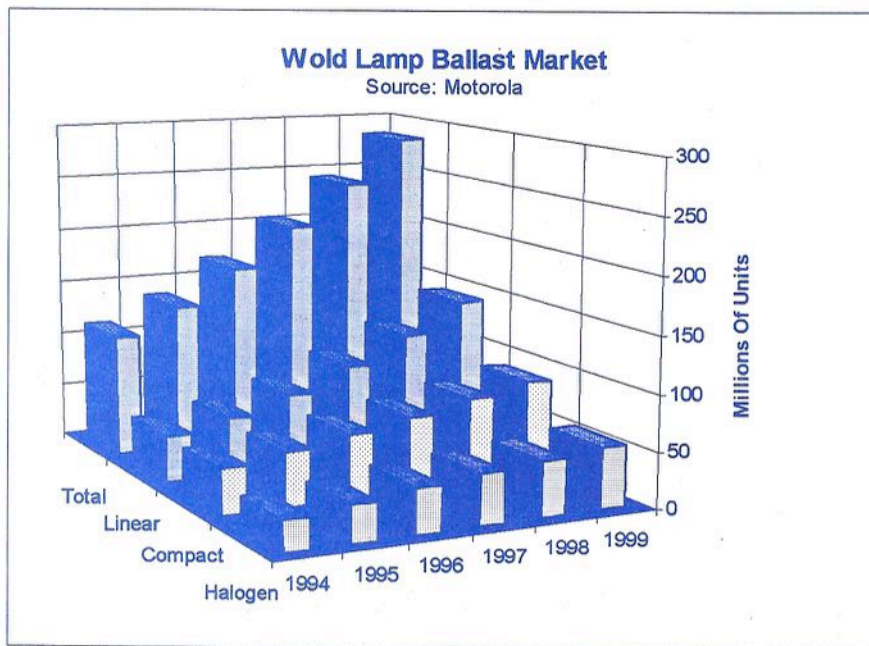
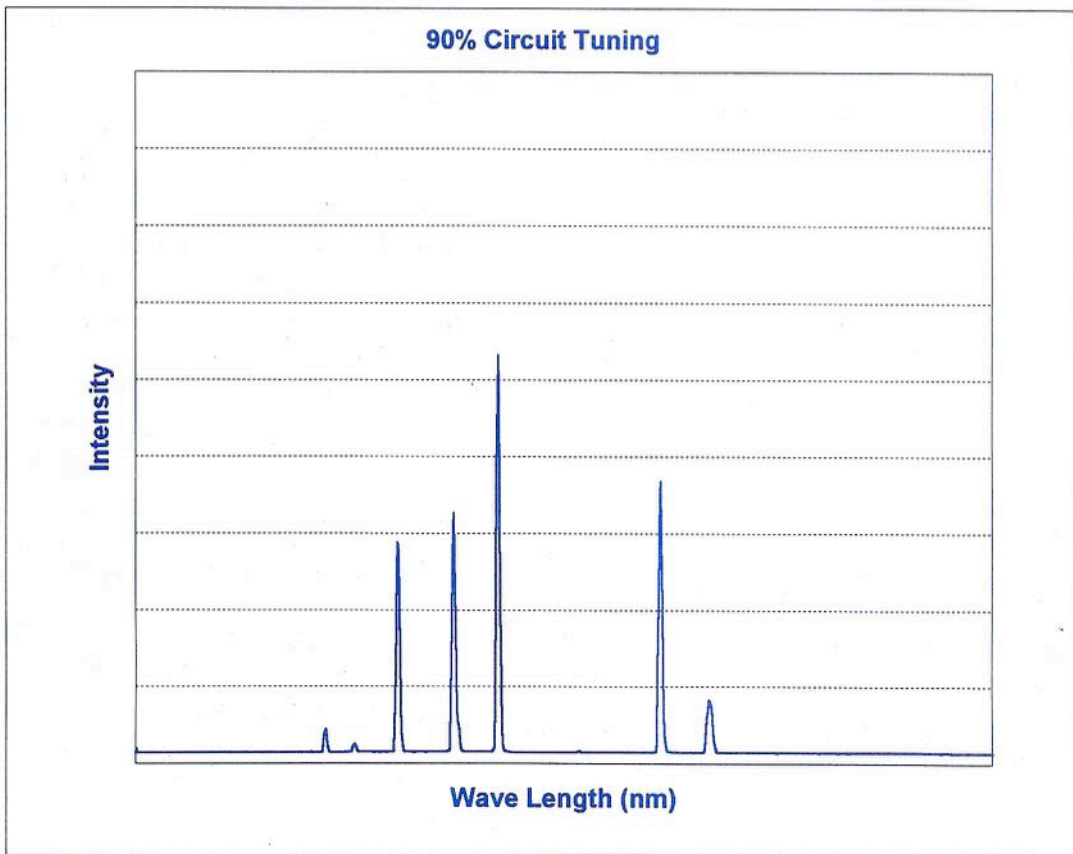
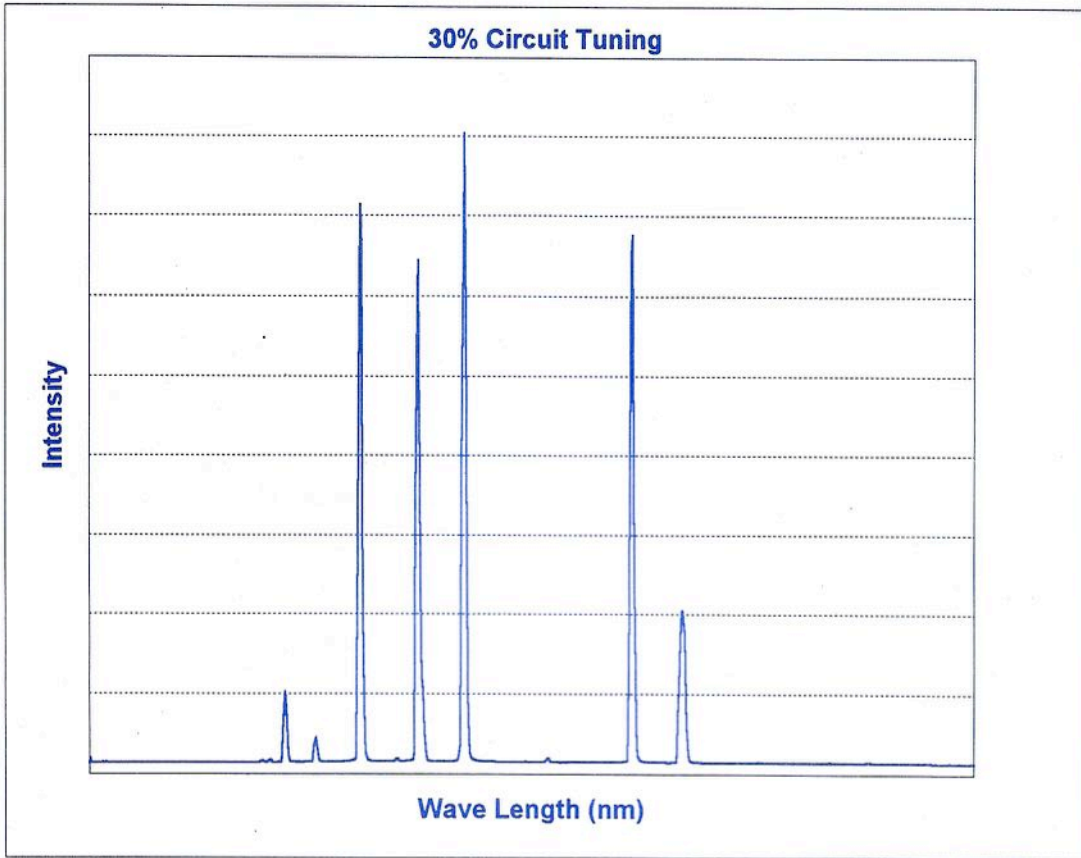

Figure 6. World Wide Sales Of Electronic Ballasts. Application of Spectral Amplitude Shifting has the potential to be used in a world wide market that predicts the use of over 250 million units per year by the year 1999.

Adaptable to present installations, spectrum shifting will allow users to cut their power consumption in half. Spectral Amplitude Shifting can also be used for new installations of gas discharge lighting. The switching circuit can be incorporated into the lamp fixture and it can provide a new generation of energy efficient lighting. The research as described in this proposal is expected to fluorescent, sodium and metal halide discharge lamps.

Given the wide spread use of gas discharge lighting, it is expected that the commercial potential is as large as the installed base plus the number of gas discharge lamps sold each year.

Wireless Engineering is seeking partners in development of this technology. Inquiries should be addressed to Wireless Engineering, Inc., 760 Prairie Avenue, Craig, CO 81625.



## Preliminary Results of Electron Microscopy and Electron Diffraction Spectroscopy of Carbon-Carbon Arc Experiments

Toby Grotz, Don Rapp

Recent experiments<sup>1</sup> have failed to verify transmutation of carbon (C) to iron (Fe) in carbon arc discharges using carbon rods and carbon powder. Because microgram quantities were reported by J. Sundaresan and J.O'M Bockris<sup>2</sup> during arcing over a much longer time (24 Hrs) than used in our experiments (10 mins.) we decided to pursue examination of the results of arc discharging in air using scanning electron microscopy (SEM) and electron diffraction spectroscopy (EDS).

Using the SEM to identify particles of interest, EDS is then used to zero in on small sections of a microscopic particle and x-ray scattering is used to identify the elemental composition of the particle. The carbon powder used during this test was graciously provided by Kenjin Sasaki of Nagaiki Company. Ltd., Tokyo, Japan.

Several samples of carbon subjected to carbon arc discharge were analyzed in the laboratory of Professor John Dash at Portland State University. The photos of two types of particles found in the carbon and the elemental analysis accompany this text.

During the course of this investigation, we noticed that extremely powerful 2"x2"x1/2" neodymium magnets were able to remove very fine particles of magnetic material from the carbon before the arcing process was begun. These particles resemble the type in the photograph and graph labeled as "Japanese Carbon ..After Reaction" Because these particles also appear in the material after processing in addition to the type in the photograph labeled "Japanese Carbon Discharge Sample", we formed the following hypothesis.

1. During the grinding process used to pulverize and produce powdered carbon, contaminants in the form of small particles of steel are added to the carbon powder. These contaminants have a characteristic shape and composition. The source of these contaminants is probably the grinding surface of the machines used to produce the powder, e.g. the balls in a ball mill. These particles have the form, shape and composition of the material detailed on the graph labeled "Japanese carbon discharge sample".
2. Once these contaminants are removed, another type of particle can be extracted from the carbon powder after carbon arc discharges. The composition of these particles differs from the former in the lack of silicon (Si), but have Aluminum (Al), Chromium (Cr) and a much higher ratio of iron to calcium (Fe/Ca).

Although much more analysis need to be done to determine if low energy nuclear changes (transmutation) are occurring in carbon arc discharges in air, it appears that there may be transmutations that are producing iron, chromium, and aluminum. Much more testing is needed before decisive conclusions can be made.

---

<sup>1</sup> Grotz, T. "Investigation of Reports of the Synthesis of Iron via Arc Discharge through Carbon Compounds", *Fulcrum*, Vol. 4, No. 3, October 1996.

<sup>2</sup> R. Sundaresan and J.O'M. Bockris, Anomalous Reactions During Arcing between Carbon Rods in Water", *Fusion Technology*, Vol. 26, Nov. 1994.

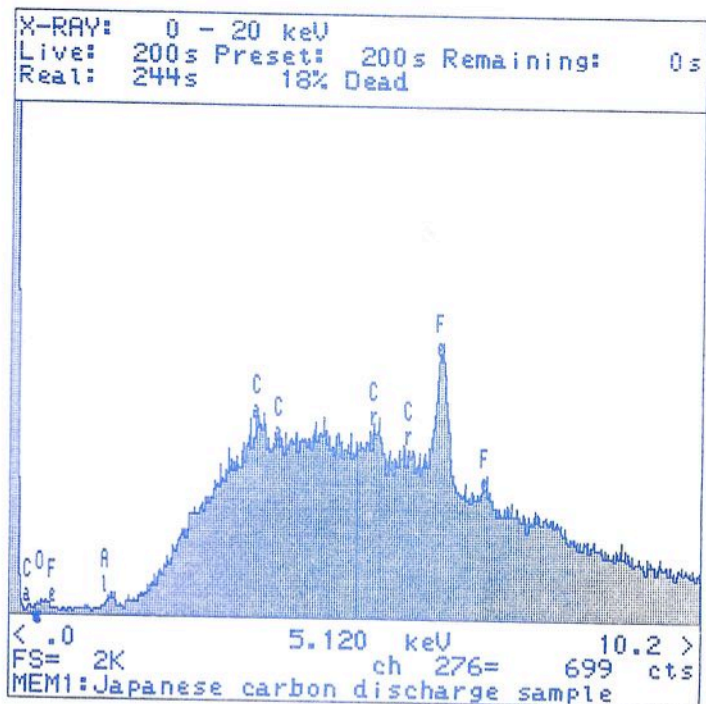
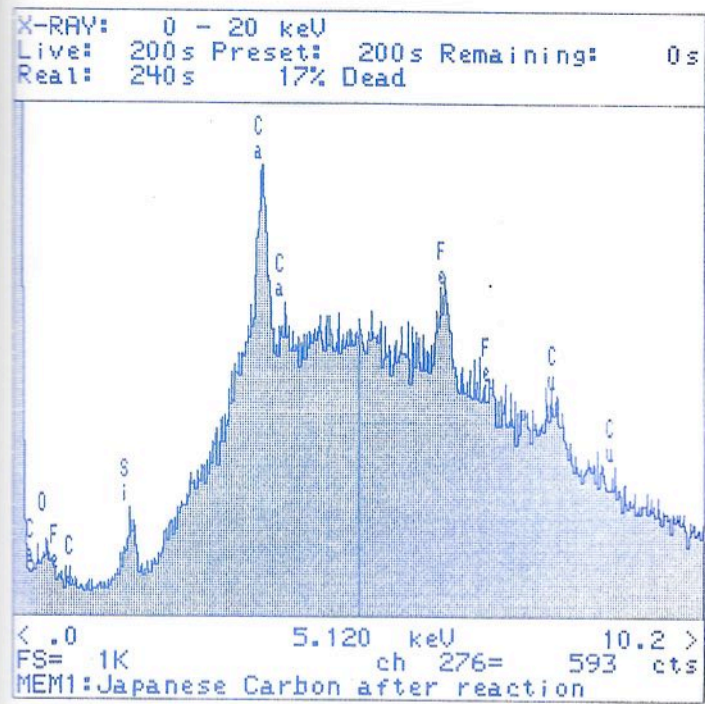

MEM1: Japanese Carbon after reaction

WINDOW LABEL	START keV	END keV	WIDTH CHANS	GROSS INTEGRAL	NET INTEGRAL	EFF. FACTOR	%AGE TOTAL
N Ma	.16	1.90	88	9710	-23686	1.00	124.57
CaKa	3.56	3.92	19	13450	2839	1.00	-14.93
FeKa	6.16	6.56	21	12071	1834	1.00	-9.64

MEM1: Japanese carbon discharge sample

WINDOW LABEL	START keV	END keV	WIDTH CHANS	GROSS INTEGRAL	NET INTEGRAL	EFF. FACTOR	%AGE TOTAL
Al YbMa	1.40	1.68	15	1074	309	1.00	5.18
CrKa	5.28	5.56	15	10739	1094	1.00	18.34
FeKa	6.20	6.56	19	15908	4157	1.00	69.69
Fe Ln	6.92	7.22	16	7957	405	1.00	6.79

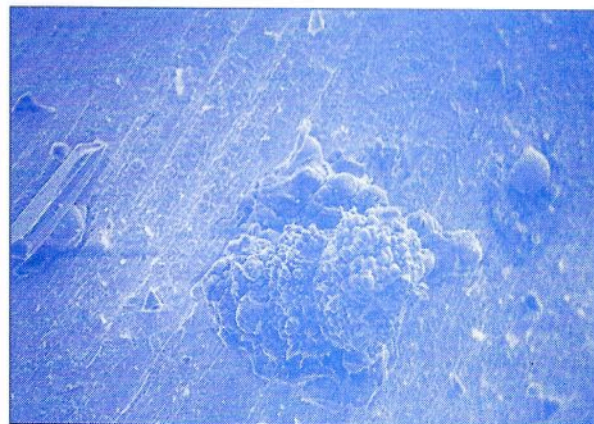
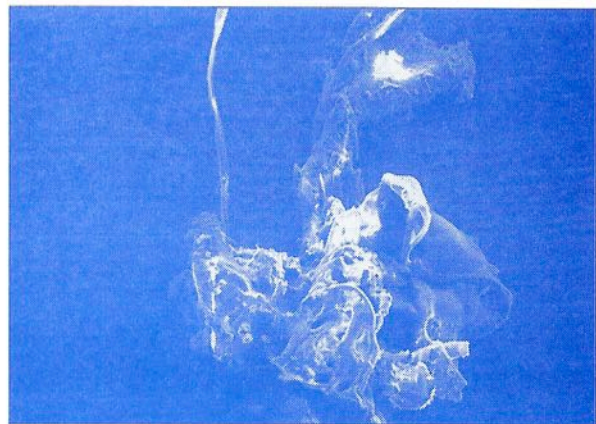

## From The Archives

July 1/59

Dear Howard;

That certainly is nice of you to make that offer of help to us in our effort to get one essential thing into patentable shape before the book comes out. The hostility of science to cosmically acquired knowledge makes it impossible for us to secure even minor grants while any nincompoot with a penny sized idea can get grants of hundred thousand dolla: sizes with the greatest of ease.

The small scale lenses I need should not cost over that amount and the metal parts would not cost half that. I will make accurate drawings and specifications for sizes and ask how much they will cost. If they exceed \$200. I will scale down the sizes; but they are but "toy " sizes anyhow.

Our season is a nightmare. Only 26 on a beautiful Sunday where we used to have 300. The same everywhere. Down at the motor court Scanland had only 29 of his 60 rooms rented - 31 on Saturday and 41 is a high spot in contrast to full houses of sixty and turning away over a hundred. All of the tourist business is less than half. Thank goodness we have our book sales and the course with a big inventory, but we only break even at that. This book will break through science this time and make them eat the dust of humiliation, or I do not know my onions. Lao's part of is equally marvellous. Yesterday we worked together all the afternoon - which was a great treat, for we hardly get together till after dinner. I work over at Arthur Jones cottage which we call Blue Ridge Cottage. It is quiet there and I sleep in the air and ride my bicycle about four times a day for two or three minutes. I find it helps mt patella ligaments.

Yes, the lucite cubes will be all right for this purpose I need them for - which is to do things to them and photograph the results. If it was for optical effects I would need glass or quartz, and I will have them that way some day.

I never felt better in my life. Would never go back to that diet of poison. Many children are sick and the doctors do not know what is the matter with them. They do not even ask what the child eats - just gives them a shot. They probably eat Kellogs breakfast food cereals which are embalmed with formaldehyde to keep them crisp. What is the matter with the M. D's? There should be a law limiting medical practice to chiropractors and osteopaths. By the way, a group of Canada Ohiropractors are coming all the way down here on the 17th & 18th to ask a lot of questions. They are nice chaps. A Dr. Reinhardt heads the party.

Lao joins me in sending her love and a couple of hugs.

Always yours,

*Doctor*  
*Walter Russell*



Knowing of your interest in our scientific work through our valued friend and co-director Dr. H. Walter Lavender, who informed us of your proposed visit, we felt that a perusal of the enclosed proposal prior to your visit would be helpful to you.

A revolutionary change in your power producing machines by doubling their current potential and inductive powers, would be the first step toward unlimited fuel by transmutation - and at negligible expense.

I know that you are aware of my husband's conspicuous contributions to science, which are more specifically detailed in the introduction to our recent book, "ATOMIC SUICIDE."

Dr. Russell would make the unknown secrets of Nature applicable to your chemical and electrical processes as more specifically outlined in the attached proposal and program. The first of Nature's supreme secrets which he would reveal would be her method of transforming the static condition of space to the dynamic condition of matter and motion. This has been said to be a hopelessly insoluble problem.

The basis of this transformation lies in the Russell coil, which conforms to Nature's processes, and is the key to the science of tomorrow. Naturally the owner of the patent rights to this revolutionary coil would possess the greatest of all assets in power production, for, as you know, the solenoid coil is its basic tool for multiplying power, which the present coil only weakly approximates.

We are looking forward to your visit and trust that you and your associate will be our guests for this occasion.

With our kindest regards, I am  
Sincerely yours,

UNIVERSITY OF SCIENCE AND PHILOSOPHY

Lao Russell, President

PROPOSAL FOR MULTIPLYING POWER  
by the  
RUSSELL COSMOGONY

The Russell Cosmogony is based upon the control of matter and energy by its CAUSE in the invisible light of space instead of from its EFFECT in matter.

Program for plan to be carried out in three stages in a suggested period of three years.

FIRST STAGE

POWER MULTIPLICATION - ELECTRICALLY - BY VISIBLE LIGHT

This stage to be demonstrated by the new principle of transforming the static condition of the invisible light of space to the dynamic condition of the visible light of motion. The mechanical means to be used in this demonstration are as follows:

- 1 - The Russell coil built in accord with Nature's principle of power production and designed to double productive power of previous coils.
- 2 - The Russell dynamo completely re-designed to double inductive power of present machines.
- 3 - A new armature constructed on Nature's principles which eliminates the gramme ring.
- 4 - A new core, built on Nature's principles, which eliminates the "drag" of the present one.
- 5 - A new yoke which also eliminates drag.

This stage is now ready for launching in accordance with the program herein attached.

Time allowed for demonstration of first stage - six months

SECOND STAGE

POWER TRANSMUTION - ELECTRICALLY, CHEMICALLY & OPTICALLY

Power transmutation is based upon the new tonal principle of matter.

The first objective of this new power is to obtain a plentiful supply of free hydrogen at negligible cost to take the place of the dangerous atomic power now planned for future power generation. The knowledge which is necessary for this process can be applied to gases only for its first period. When this stage has been mastered solids can then be transmuted by first reducing them to gases.

Time allowed for demonstration of second stage - one year.

THIRD STAGE

POWER PROJECTION - WIRELESSLY - BY INVISIBLE MAGNETIC LIGHT

Power projection is based upon the new optical principle of the invisible light of space.

The primary purpose of power projection is its commercial value of eliminating cables for power transmission through knowledge of the control of Nature's manner of power transmission by light-waves, by means of which she causes every thing which happens anywhere to repeat itself everywhere. Its ultimate purpose is to make war impossible by making every nation invulnerable from attack by any other nation without need of armies or navies. This third stage will begin when the first and second stages have become commercially operative.

Time allowed for demonstration of third stage - one to two years.

\* \* \* \* \*

PROGRAM FOR FIRST STAGE REGARDING MULTIPLIED  
POWER PRODUCTION

This stage will be covered by a series of approximately five lectures and necessary question periods. They will be copiously illustrated by color diagrams, models and Crooks tubes to visualize principle in vacuum, under high frequency current.

PROGRAM FOR FIRST STAGE CONTD.

Subjects to be:

- 1 - A preliminary talk upon the nature of space and its hidden secrets, which will become the basis of the science of tomorrow. The Russell coil and dynamo will be the first application of the new science.
- 2 - An explanation of the optical nature of the universe and its relation to gravity and the magnetic field. Also an explanation of the lenses and mirrors of Nature and their relation to radar, the wave and electricity.
- 3 - An explanation of anti-matter and the cathode-anode relation to cathode rays in the creative process. Comparison of the cathode with the wave fulcrum from which the wave lever of motion is extended to simulate energy in matter instead of in space.
- 4 - An explanation of the new science of space-geometry.
- 5 - The cube basis of space and the sphere basis of matter. (This explains how the invisible universe of zero curvature in its wave-field forms creates a curved universe of rings and spherical forms.)
- 6 - The nature of fire and water to each other and to space and matter.
- 7 - The tonal principle of Nature as manifested in the octaves of the elements.
- 8 - Explanation of the relation of the magnetic field to chemistry, and more especially, to the chemical bond and crystal structure.
- 9 - What the electron is and HOW it is created, together with its relation to electricity and magnetic field.
- 10 - Comparison of the relation of the armature of a dynamo to the sun of a solar system. Explanation of why the present armature is not representative of the sun, as it should be.
- 11 - Explanation of what electricity really is - and why the word electricity, and the terms positive and negative, have no meaning in Nature.
- 12 - Explanation of the rings, spirals and spheres in Nature.
- 13 - Explanation of the unknown process of inside-out and outside-in process of Nature.
- 14 - A final analysis of the present dynamo as compared with the Russell dynamo; unit by unit - the yoke, the core, the gramme ring and the armature. Also an explanation of "lines of force," which have no existence in Nature.

# Patent Papers

Nov. 12, 1957

L. R. CRUMP  
 POWERING ELECTRICAL DEVICES WITH ENERGY  
 ABSTRACTED FROM THE ATMOSPHERE  
 Filed March 12, 1954

2,813,242

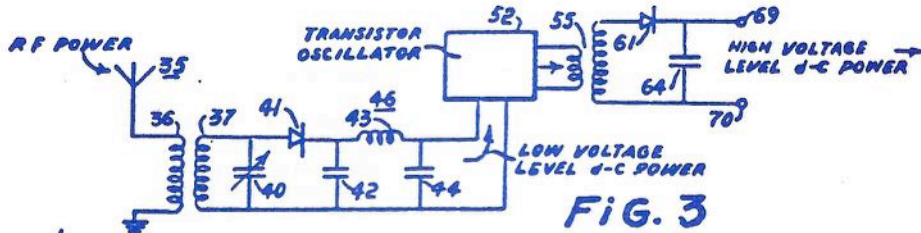

FIG. 3

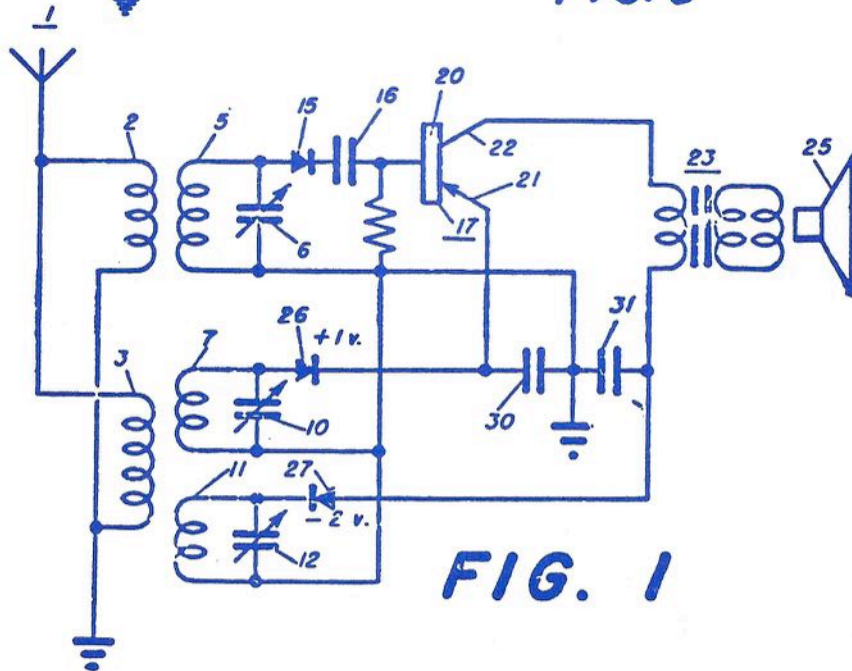

FIG. 1

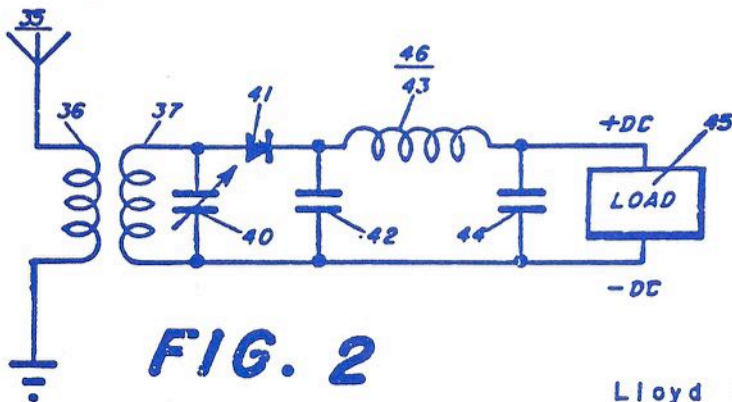

FIG. 2

INVENTOR  
 Lloyd R. Crump

BY *W. E. Philbodeau & A. Ill Dew*  
 ATTORNEYS

1

2,813,242

## POWERING ELECTRICAL DEVICES WITH ENERGY ABSTRACTED FROM THE ATMOSPHERE

Lloyd R. Crump, Silver Spring, Md.

Application March 12, 1954, Serial No. 415,986

1 Claim. (Cl. 321-2)

(Granted under Title 35, U. S. Code (1952), sec. 266)

The invention described herein may be manufactured and used by or for the Government for governmental purposes without payment to me of any royalty thereon.

This invention relates to the convenient and economical provision of power for the operation of electronic circuits and devices using transistors, and of other electrical devices having modest power requirements.

A great advantage of transistors, and a major reason for their enthusiastic reception since their introduction a few years ago, is the fact that they will operate satisfactorily with very low supply voltages and currents. One milliwatt or even less is sufficient to power a transistor in many applications. Various batteries have been developed to provide, in a minimum of space, the relatively minute amounts of power needed by transistors.

My invention provides methods and means that permit transistor circuits, and also other low-powered electrical devices, to be economically and conveniently operated without any batteries whatever, and indeed without any power supply whatever as power supplies are ordinarily conceived.

The invention centers around my discovery that it is practicable to construct operative transistor circuits that are able to abstract from the atmosphere sufficient electromagnetic energy to provide all necessary supply voltages and currents for their own operation. Circuits and devices powered according to my invention will operate indefinitely without any local power source whatever.

I have successfully constructed and demonstrated such circuits. For example, I have constructed a batteryless transistor radio receiver on which I have listened to either nearby or distant broadcast stations as desired, using either headphones or a loudspeaker; this receiver has been powered entirely by electromagnetic energy abstracted from the atmosphere.

From the successful operation of this receiver, and from other experimental work, it becomes clear that, by the methods and means of the invention, a great variety of practical and useful transistor circuits can be powered entirely by energy abstracted from the atmosphere.

Furthermore, as will become apparent below, my invention is applicable to the powering of other electrical devices requiring relatively small amounts of power.

An object of the present invention is to provide methods and means for powering transistor circuits entirely from radiofrequency energy abstracted from the atmosphere.

Another object is to provide methods and means for powering remote radio receivers, low-powered radio transmitters, and other low-powered electrical devices, with energy received by radio from a master station, so that no local power supplies are needed by the devices and so that the powering or non-powering of the remote device is under the control of the master station.

A further object is to provide methods and means for powering transistor circuits and other low-powered electrical devices with radiofrequency energy received from one or more remote radio transmitters.

2

Other objects, aspects, uses, and advantages of the invention will become apparent from the following description and from the drawing.

Figure 1 is a schematic diagram of a transistor radio receiver in which all necessary power is supplied by energy abstracted from the atmosphere in accordance with the invention.

Figure 2 is a schematic diagram showing a general application of the invention to provide direct-current power to a load.

Figure 3 is a schematic diagram of a system for obtaining a high energy D.-C. source at a high voltage level using energy abstracted from the atmosphere.

Referring to Figure 1, a receiving antenna 1 is connected to antenna coupling coils 2 and 3, the other ends of which are connected to ground. A parallel resonant circuit consisting of coil 5 and capacitor 6 is coupled to coil 2. A second parallel resonant circuit consisting of coil 7 and capacitor 10 is coupled to coil 3. A third parallel resonant circuit consisting of coil 11 and capacitor 12 is also coupled to coil 3.

Coil 5 and capacitor 6 are tuned to the frequency of a radio transmitter from which it is desired to receive information—for instance, an amplitude-modulated standard broadcast station. The signal received from this transmitter need not be strong. The signal is detected by diode 15 to obtain an audio-frequency information signal. This audio signal is coupled through a capacitor 16 and is amplified by a circuit that includes a transistor 17 having a base 20, an emitter 21, and a collector 22. The amplified audio output of the transistor is coupled through an audio transformer 23 to an electroacoustical transducer, preferably a permanent-magnet dynamic loudspeaker 25 as shown.

The novelty of the invention lies largely in the method and means by which the necessary direct-current power is supplied to the emitter and collector circuits of transistor 17. This method and means will now be described.

Coil 7 and capacitor 10, and also coil 11 and capacitor 12, are tuned to receive radio signals of relatively high strength. It does not matter whether these signals contain information. These power signals are rectified by diodes 26 and 27 to provide direct-current power that is filtered by capacitors 30 and 31. The D.-C. power thus obtained is utilized to power the transistor 17.

In the circuit shown, two tuned circuits (coil 7 and capacitor 10, and coil 11 and capacitor 12) are tuned to power signals and the D.-C. voltages obtained from each are connected in series. The tuned power circuits may be tuned to the same or different power signals. Under certain circumstances it may be desirable to use more than two tuned power circuits and to tune them to more than two power signals; in this way power can be obtained from several signals and combined. On the other hand, if a strong power signal is available, a single tuned power circuit may suffice to give the needed D.-C. power.

Even weak information signals can be received successfully. A plurality of transistor amplifier stages can be used if desired, or other circuits such as superheterodyne circuits can be used. It is merely necessary that a sufficiently strong power signal or signals be available to provide the small amount of D.-C. needed to power the transistors.

If the information signal happens to be strong, it can be used as the power signal; all of the tuned circuits (coil 5 and capacitor 6, coil 7 and capacitor 10, coil 11 and capacitor 12) are tuned to the information signal.

Engineers who have observed my invention in operation have been surprised at the unexpectedly good results obtained, even with readily available power signals of quite moderate strength. For instance, sufficient power for satisfactory operation of a loudspeaker at low volumes is

3

readily obtained from a 5-kilowatt standard broadcast station 5 miles away, using only an indoor antenna to pick up the power signal as well as information signals. In typical operation under these conditions a D.-C. voltage of about 2.5 to 3 volts is obtained between the emitter and the collector, at a current of about 250 microamperes; D.-C. power input to the transistor is thus of the order of 0.5 to 1 milliwatt. So far as I am aware, no one has ever before discovered and demonstrated the practicability of this method of powering a radio receiver.

Because existing broadcast stations within a radius of a number of miles provide adequate power signals, the invention is readily practicable with existing power signals in almost any location in or near any city in the United States.

Although I have described a transistor radio receiver powered by my invention, it will be readily apparent that the invention is applicable to the powering of any transistor circuit using one or a number of transistors, and to the powering of other devices requiring relatively small amounts of power. For instance, sensitive electro-mechanical, electrochemical, or electrothermal devices can be operated by the method of the invention.

Referring to Figure 2, which shows a more general embodiment of my invention, an antenna 35 picks up radio-frequency energy from the atmosphere. This energy flows through coil 36, which is coupled to a tuned circuit consisting of coil 37 and capacitor 40. The radio-frequency voltage across capacitor 40 is rectified by diode 41 and filtered by a low-pass filter 46 consisting of capacitors 42 and 44 and choke coil 43. The resulting D.-C. voltage is applied to a load 45.

In the practice of my invention, larger amounts of power can be obtained for short periods of time by storing received energy in a suitable energy storage device. Stored energy may then be withdrawn at intervals at a more rapid rate than that at which it was received and put into the storage device. In this way the invention can be used to provide short pulses of relatively very high electrical energy. This result can be readily obtained by charging a relatively large capacitor with direct current and then discharging the capacitor rapidly into a load when desired. This rapid discharge can be initiated automatically when the voltage across the capacitor reaches a certain level, or it can be initiated when a transistor radio receiver receives a certain information signal.

Higher voltages can be obtained with the invention by means of well known devices for raising D.-C. voltages as shown in Figure 3. The D.-C. voltage output from the capacitor 44 can be used to power a low frequency transistor oscillator 52 whose A.-C. output is raised to a higher voltage level by the transformer 55. This relatively high A.-C. voltage can then be rectified by a diode 61 and fed to a capacitor 64 to provide a high energy D.-C. source at a relatively high voltage level at the terminals 69 and 70. If desired, energy can now be withdrawn from the capacitor 64 at intervals in short pulses of high energy at a high voltage level. Pulsed radio transmission is one of the possible uses for this form of the invention. Other uses would be to provide a single relatively powerful pulse needed to actuate an electrothermal or electromechanical device.

As has been indicated above, in many locations and particularly anywhere in or near most American cities, power signals normally present in the atmosphere are readily available for the easy and convenient practice of the invention. However, the invention also has important applications in systems in which the necessary power signal is generated and transmitted specifically for the operation of the particular system. Such systems can, for example, comprise a master station transmitting all the power that is needed for hundreds or thousands of fixed or mobile transistor receivers or other remote devices over

4

a range of many miles. This eliminates the need for hundreds or thousands, as the case may be, of local power supplies. At the same time, such a system has the advantage that all of the remote devices can be simultaneously activated or deactivated at the will of the master station, simply by starting or stopping the transmission of the power signal. In such systems it will often be advantageous to use power signals of frequencies sufficiently high to permit the use of resonant receiving antennas of small physical dimensions for signal pickup at the remote devices. In addition to the power signal, the master station may transmit an information signal on the same or a different carrier.

Certain types of devices powered entirely by received radio waves are of course well known. The well-known "crystal set" of the early days of radio, which used a diode rectifier to demodulate an amplitude-modulated radio-frequency signal, is an outstanding example of such a device. My invention is readily distinguishable from such prior devices, however. In typical prior devices a modulated radiofrequency signal is applied to a diode to obtain unidirectional half-wave pulses whose amplitudes vary with modulation. These pulses are integrated by means of a capacitor to obtain a unidirectional signal the amplitude of which follows the audiofrequency modulation envelope. If the radiofrequency signal is received with sufficient strength the audio signal may have sufficient power to operate headphones or similar utilization device without power amplification; but the signal is utilized for its information content, rather than to supply non-information-containing power.

My invention, on the other hand, entails the utilization of received radiofrequency energy to supply power to at least one pair of circuit points (across capacitor 31 in Fig. 1, for example), such circuit points requiring power solely for its power content and not for any information or modulation it may contain. In other words, my invention entails the utilization of radiofrequency energy to supply power that would otherwise have to be supplied by batteries, generator, or other local power source.

It will be apparent that the embodiments shown are only exemplary and that various modifications can be made in construction and arrangement within the scope of the invention as defined in the appended claim.

I claim:

An electrical device for obtaining a high energy D.-C. source at a high voltage level using energy abstracted from the atmosphere, said device comprising in combination: resonant means for receiving radio waves, first rectifier means for converting said radio waves into first direct current energy, first capacitor means for storing said first direct current energy, an oscillator powered by said direct current energy, said oscillator producing an A.-C. output, transformer means for raising said A.-C. output to an increased voltage level, second rectifier means for converting the A.-C. output of increased voltage level from said transformer into second direct current energy, and second capacitor means for storing said second direct current energy.

#### References Cited in the file of this patent

##### UNITED STATES PATENTS

1,540,993	Piauson	June 9, 1925
2,056,824	Cawley	Oct. 6, 1936
2,553,734	Adler	May 22, 1951
2,569,687	Pan	Oct. 2, 1951
2,647,957	Mallinckrodt	Aug. 4, 1953

##### OTHER REFERENCES

Turner: "A crystal receiver with transistor amplifier," Radio and Television News, January 1950.

## Some of Our Current State (+ & -) Almost a Half Century After Publication of *The World Crisis, Atomic Suicide?*, etc.

**Health & Healing** - It is thought that we can re-energize ourselves in seven days by physically spending five minutes inhaling and exhaling deeply with our hands on our ribs before getting out of bed in the morning; by spending thirty minutes with our friends and social network, family, etc. by phone, letter or in person; mentally by listening to our favorite soothing music for half an hour uninterrupted; and emotionally by jotting down all the good things that happened to us during the day before we go to sleep. Western Washington state, which has a population of about 170,000 Blacktail deer is experiencing a disease in the herds characterized by large bald patches, bluish skin and white blotches on the fur. This disease has proved to be fatal in some cases to yearlings. Washington state wildlife officials think the disease is caused by a virus. R. E. McMaster Jr. *The Reaper* 7/10/97. I am going to suggest to my patients that they do this and then let *Fulcrum* readers know the results. Perhaps any of you who might do it could share results too. In regards to the Blacktail virus, remember Western Washington state is where the Hanford Nuclear facility is located and is leaking its poison into the environment. With the newly discovered method of transmuting radioactive waste the Government should utilize it on site to transmute these poison piles. See the section on Science & Technology for more info on this process. I also feel that we each can transmute radioactive contaminants in our bodies into non-radioactive ones when we are healthy. Biological organisms have been known to transmute elements of all types, including radioactive elements, for a long time. Louis Kervran's work details some of this as far back as the 1960's!

**Earth Changes** - Gordon Michael Scallion in his *ECR* has the following to say: "I now predict that this El Nino will be the worst in recorded history. Expect especially heavy effects along the US West coast and those states bordering the Missouri and Mississippi rivers, although this is only a small part of what I see ahead. I see El Nino causing the breakup of dozens of dams in these areas, as well as others. The damage will be staggering. My visions show many dam and levee failures along the Colorado and Mississippi rivers, in Oregon, the Dakotas, and Idaho". In an Oct 8th report from *Reuters* news service, a group of French scientists said: ... the earthquakes shaking the Italian town of Assisi do not fall into the usual pattern of quakes. Instead of subsequent quakes dropping off in magnitude, they are increasing...GMS also said, "If activity occurs both in the Caribbean and Italy at the same time, then "mega" earth changes will occur in the U.S. and other countries within months. All of these events should be seen as final warnings before a magnetic pole shift, which will be triggered by solar flare activity". GMS also feels that denial is the state of mind of those in control of the world purse and power strings in regards to earth changes. He related the following story: "A U.S. government research scientist with whom I recently met told me, ' we ( the scientific community) know earth changes are coming. But the consensus is that we can do nothing without upsetting the current delicate balance of the global economy. If we were to announce what we know publically - and admit that we don't know what to do - it would start a worldwide panic that could be worse than keeping quiet and letting events unfold. And besides, there's always the chance that we - and you - are wrong. Maybe nothing will happen after all'. While I appreciated his candor with me, I



found myself getting angry. Not at him specifically, but at the general acceptance that nothing can be done. I learned early-on in my intuitive work that huge changes can occur in a flash, a moment, when backed by belief. The future is what we decide.” (*Earth Changes Report*, November 1997.) Of course Montserrat in the Caribbean has blasted off at the same time as the quakes in Italy. We shall see what the next few months bring us and I agree with GMS and decide to make mega changes for the better in my life and in yours in whatever fashion I am able.

**Government/ Politics** - “few would disagree that the danger of a new Arab-Israeli war has been brought considerably closer by recent Russian actions. There is every possibility that Moscow, for reasons of its own, has taken a decision to precipitate an Arab-Israeli war within that time frame... The next 18 months the middle East will be fraught with danger and it will take statecraft of the highest order on the part of the United States, if a catastrophic war in the Middle East involving chemical, biological, and nuclear weapons is to be avoided. Former Russian security chief General Alexander Lebed has recently revealed that not all of the 100 suitcase size nuclear bombs with which Soviet special forces were armed have been accounted for. This may have been said for homegrown political reasons or he may have been acting under orders when he let this snippet drop into public domain. Whether or not any of these suitcase nuclear bombs have actually gone missing is now almost irrelevant. After Lebed’s statement, what American President is going to call the bluff of a terrorist group that says it has one (or more) of these bombs (described by Lebed as “ideal for nuclear terror”) which it is going to explode in an American city (Or cities) in the event the United States moves to protect Israel against an Arab/Iranian assault? *Intelligence Digest*, September 1997.

**Religion** - The Pope has recently stated in public that during WW II Christians did not do enough to resist the Nazis decimation of the

Jews. Yes, this is so, and it appears that humanity has done relatively little to heed and live by many of the precepts of any of the world religions. The Russell’s felt humanity needs to understand Universal Law and that what we give is regiven to us in kind, in time, which is another way of stating the ancient law of karma, the scientific law of cause and effect, commonly spoken of as ‘what goes around comes around’.

**Art** - Where have all the artists gone, long time coming? Artists struggle for sustenance and recognition in our culture where the business of the world is business. The Russell’s decried our civilization’s neglect of the arts and artists. They felt art was food for the soul and that the world would be vastly enriched if we could encourage, support, and patronize artists. Anyone have information or ideas on actions that might be or are being taken to encourage, develop and support art and artists that I might share with readers?

**Science and Technology** - There has been a major technological breakthrough this last year. A group in Cincinnati has achieved the transmutation of radioactive waste! They are selling their radioactive remediation kit for approximately \$3,000 for individuals, labs and research groups who wish to participate in the development of this incredible technology. This appears to be a solution to our worst environmental disaster, radioactive contamination of our biosphere, by the newly emerging transmutation science. The Russell science research team is marketing this radioactive transmutation/remediation kit as well as going to do research with it in our development program. See the advertisement in this issue for more details. The US Government and the Dept. of Energy should be using, researching and developing this new transmutation science to shut down and clean up our nuclear reactors and nuclear weapons production wastes right now. The entire world should be using, researching and developing this science to provide for everyone’s basic needs to create a sustainable, healthy and vital civilization.

# ATOMIC THEORY CHALLENGED

by E. Don Rott

Professor Yull Brown's discovery of the first known 'imploding' vacuum producing gas, "Brown's Gas," provides an opportunity to challenge the accepted theory regarding the structure of the atom.

Nikola Tesla and Walter Russell both challenged the present theory. In addition, the current writings of Paramahansa Tawari, a theoretical physicist from India, also makes the same argument. Contemporary physics texts state that a structure somewhat akin to electromagnetic rubber bands emanating from the nucleus hold the component parts of an atom in orbit around its centering nucleus. Tesla, Russell and Tawari have disagreed for years.

In Walter Russell's book, "ATOMIC SUICIDE," published in 1957, by The University of Science and Philosophy, Waynesboro, VA, he writes the following on page 14. "*The one amazing thing about matter, which is not known today, is that matter is not held together from within by the attraction of gravity, as generally supposed, it is compressed together by a force exerted from the outside towards its center.*" Tesla, a personal friend of Russell's, agreed. In addition, Tawari has written the same proposition in his books.

Approximately twenty five years ago Yull Brown made what may some day be recognized as the most significant scientific discovery of the twentieth century, Brown's Gas. It is a gas composed of atomic hydrogen and oxygen. The gas is produced by dissociating water by electrolysis in a generator patented by Brown. The gas has the property of **IMPLOSION** when ignited. Science has never known of a gas with this property. When expelled under pressure from a single tube and ignited, it produces a room temperature imploding flame. The inner mantle of the flame is a **VACUUM**.

Brown's Gas enables us to investigate what these three great scientists have told us. By placing elements, e.g. tungsten, carbon, etc., within the imploding inner mantle vacuum of the flame, the

electron shells surrounding an atom can be peeled away like an onion. Many, including Yull Brown, have commented that the temperature of a Brown's Gas flame varies depending upon what it touches. Technically, this is not true. The temperature of the flame does not change as it impinges on varying materials. The heat energy released is produced by breaking the atomic bonds of the elements being placed within the inner mantle of the flame. The tremendous heat generated approaches, and in fact may equal the temperature of the sun.

Just as Tesla, Russell and Tawari have told us, the atom is held together by pressure from the outside. As the slightly pulsating vacuum within the inner mantle of a Brown's Gas flame removes the normal atmospheric pressure, 14.7 pounds per square inch, atomic structures break apart.

The following test has been demonstrated by Yull Brown and this author many times. The elemental gases sublimated from pointed rods of tungsten or carbon graphite that are placed within the flame's vacuum are elements not present in the original.

**THIS IS TRANSMUTATION!** A room temperature Brown's Gas flame is obviously not hot enough to cause this reaction. Nor is the temperature of any ignited gaseous mixture of molecular hydrogen and oxygen (2200-2900 degrees C.) However, by removing normal atmospheric pressure surrounding atoms with the slightly pulsating vacuum of a Brown's Gas flame, we produce **a new scientific reaction; a controllable, non-radioactive, atomic reaction.** proving what Tesla, Russell and Tawari have theorized.

**THE ATOM IS HELD TOGETHER BY PRESSURE FROM THE OUTSIDE!** Professor Yull Brown's discovery, Brown's Gas, has made proving it possible.

E. Don Rott, 3137 Amherst Dallas, TX 75225  
214-691-1900 (Phone) 214(696-1748 (Fax)  
E mail: edonrott@nkn.net

---

*Ecolonomics In Action • Fall 1997 • Page 8*

**Business Commerce** - I have just received the first issue of actor and environmentalist Dennis Weaver's bi-monthly newsletter *Ecolonomics In Action*, and it is good! There are articles about new products and businesses that are examples of the marriage of ecology and economics or "ecolonomics", the new energy sciences and technologies that are here and emerging and even mention of Walter Russell's concept of atoms being held together by pressure from the outside in one article. Dennis along with his many inspired helpers has succeeded in getting his message of ecolonomics into mainstream business thinking and into education as well. The Institute Of Ecolonomics publishes the *Ecolonomics In Action* newsletter available bi-monthly for a years subscription of only \$35. Contact The Institute Of Ecolonomics Box 257, Ridgway CO 81432. I am publishing three of the articles just as they appear in the first issue of the newsletter under the science & technology, agriculture and education headings of this section of *Fulcrum*. There are articles in the newsletter about new environmentally safe dyes, papers, building materials, ecologic business, suggestions for restoring the ozone layer, new energy and more. Congratulations to Dennis and his team for the work they are doing to make a non-polluting and sustainable civilization!

## Agriculture

# THE EARTH IS FLAT, SMOKING IS COOL, AND PAPER COMES FROM TREES!

*Every now and then a fundamental misperception gets corrected.*

## KENAF TREE-FREE PAPER!

Kenaf offers a way to save trees, and reduce pollution, but that's not all. It benefits the US farmer because fewer chemicals are used in crop production, and a new cash crop means more rotation options, and that's good. A new kenaf paper industry will create much needed jobs in economically depressed rural areas, which will give new hope to the family farm.

Kenaf (*Hibiscus cannabinus* L.) is a 4,000 year old NEW concept with roots in ancient Africa. Related to cotton and okra, (and not related to hemp) it is being grown in many parts of the United States. Kenaf grows quickly, rising to heights of 12-14 feet in as little as 4 to 5 months. US Department of Agriculture studies show that kenaf's 6 to 10 tons of fiber per acre per year are 2 to 5 times greater than the annual yield for Southern pine trees, which can take from 7 to 40 years to reach harvestable size.

*Vision Paper*, of Albuquerque, New Mexico has pioneered kenaf, a tree-free and totally chlorine-free paper for the past five years. Dedicated to furthering sustainable domestic fiber and pulp production, *Vision Paper* works with US farmers and US pulp and paper mills to produce the most environmentally sound paper products available.

At the mill, kenaf requires less chemical and energy use than is required to make paper from trees. *Vision Paper's* pulp is bleached using no chlorine (TCF). No dioxins or other chlorine compounds are created or released in the pulp and paper manufacturing process. All of the pulp and paper is manufactured in the USA in strict compliance with

US Environmental Protection Agency (EPA) regulations.

Unlike trees, the stalk of the kenaf plant offers two types of fibers. The outer bast fiber is similar to the best softwood fibers used for high quality papers.

"The bast gives higher yields and the pulp has better strength properties, even superior to softwood pulps," according to researchers at the USDA Forest Products Lab in Madison, Wisconsin. The whiter, inner core fiber is like hardwood tree fibers, and can be used in a broad range of paper products. Selected by the USDA, as the "*most viable plant to replace trees in paper making*" kenaf is a sound concept from seed to finished paper.

The printing papers offered by *Vision Paper* perform as well or better than wood papers. The environmental benefits are clear. What then, is the holdup?

Tom Rymysz, President of *Vision Paper* explains. "*Until we sell enough of this paper to increase our production volume, it will be more expensive than wood based paper. It is a chicken and egg situation. We need people to buy the paper now, to support the concept, so that we can grow this industry.*

*Eventually, kenaf paper will be the same price as wood paper, maybe even cheaper. But today, we are counting on the people who buy paper and who care about the future to help us make it happen.*" ◆◆◆◆

For more information contact Tom Rymysz -  
President & Founder of *Vision Paper*,  
Box 20399, Albuquerque, NM 87154-0399 (505) 294-0293



*"Never doubt that a small group of thoughtful, committed citizens can change the world. Indeed it is the only thing that ever has!"*

MARGARET MEAD

### BUMPER STICKER PHILOSOPHY

*"Live Simply That Others May Simply Live."*

*"Taxes Are Revolting, Why Aren't You."*

*"A Mind Is Like A Parachute -  
Only Good When Open."*

*Give us your Bumper Sticker Philosophy!*

## Education

### MOVING ECOLONOMICS FORWARD

James L. Catanzaro, Ph.D., President  
Chattanooga State Technical Community College

We are very excited to be the first higher education institution in America to offer a comprehensive program of studies in Ecolonomics. Our target audience includes people in corporate management, community leaders and city planners along with undergraduate students interested in sustainability.

Ecolonomics at Chattanooga State has three areas of program emphasis: (1) how environmental stewardship and sustainability practices enhance profitability and contribute to community economic development; (2) how principles of sustainability impact facility, site, even community design; and (3) what changes in policy and decision making processes are necessary to ensure that decisions made today take into account long-term organizational and environmental requirements as well as short-term return on investment.

It is my belief that organizations, public and private, large and small, will soon have key managers play the role of bringing into every important consideration the perspective of sustainability. Just as firms nationwide have equal opportunity officers, experts in sustainable practices will be engaged to ensure a bias toward long term financial strength based on sound ecological principles. After all, the definition of sustainability includes reducing the need to make the same decision downstream (because the first decision was made to last) and reducing the requirement that work be performed just to maintain the status quo. Two pedestrian examples make these points: putting in carpeting where ceramic tile would suffice means having to replace flooring several times in a quarter century instead of never; and planting grass which must be continuously mowed, fertilized, watered, etc. requires extra efforts just to maintain the status quo where as planting beds of indigenous species requires little maintenance.

Clearly major paradigm shifts are assumed; indeed, they are critical. These shifts require philosophical reconsiderations, a new understanding of the influence of social patterns, a review of architectural, planning and management decision making processes, and a firm grasp of trends and recent findings

in environmental science and technology. The Ecolonomics Program will cover these shifts and their implications, in particular, their relationship to financial growth.

Chattanooga State will teach these courses with faculty from the departments of philosophy, sociology, management, engineering and environmental science, and without outside experts. Assistant Professor Jeanne Harrison will be the lead teacher and project coordinator.

For additional information, she can be contacted at (423) 697-4442. ♦♦♦♦

Chattanooga State is now offering a Certificate of Ecolonomics in partnership with the Institute of Ecolonomics.

The target audience for the certificate is managers, community leaders and city planners seeking a comprehensive introduction to sustainable development and those who aspire to these positions.

All courses in this certificate will be team-taught and supported by the Liberal Arts, Mathematics and Sciences and Engineering Technology divisions.

The certificate will be available through classes on campus and via distance learning using video and internet options.

#### The following courses lead to the Certificate:

Fall Semester, 1997	Credit Hours
Introduction to Ecolonomics	3
Spring Semester, 1998	Credit Hours
Sustainable Design	3
Sustainable Processes	3
<b>Total</b>	<b>9</b>

*When the idea of The Institute of Ecolonomics jelled in my mind, I knew its time was now. I knew if we are to leave a planet that will sustain life for future generations, we have to have two things: a sustainable economy and a sustainable environment, and if we fail in achieving either, we will suffer greatly.*

Dennis Weaver

**Miscellaneous** - Standard Process Labs, one of the oldest, if not the oldest, vitamin companies in the world started by Dr. Royal Lee who was a dentist that knew Dr. Russell has created their "Standard Bar". In my opinion this is the best of all the so called energy bar candy bars I have ever seen or tasted. Really good! It is something that tastes good and I really feel is good for me. Available from your local chiropractor, Naturopath, Acupuncturist, alternative or regular licensed healers.

## Newsletters/Periodicals

---

### NEW SCIENCE/TECHNOLOGY/FREE ENERGY

*Electric Spacecraft Journal*. Published quarterly, annual subscription rate \$24, Canada/Mexico \$29, other countries \$39. ESJ publishes research articles on new science, inventions and network notes from the ESJ network of individuals sharing ideas about these topics. Devoted especially to discovering the means/mechanisms for "electric" spacecraft and all that such understanding would mean for our civilization. I have known the editor Charles A. Yost the last few years and he spoke at our 1995 symposium. I find Charles' ESJ to be interesting and informative, and although most articles are very technical there are aspects of the journal that the average reader should find comprehensible and of interest. Charles A. Yost editor. ESJ, 73 Sunlight Drive, Leicester, North Carolina 28748. Phone 704-683-0313 Fax 683-3511.

*The Space Energy Journal* Published Quarterly. \$35 U.S., \$40 Canada & Mexico, \$50 elsewhere. Jim Kettner and Don Kelly editors. This journal publishes the positive and the negative results of testings of free energy machines and other new science experiments. The discussion of new science ideas is technical and yet also very down to earth so that the average reader should follow most of it. I have met Don Kelly through my association with the International. Assoc. for New Science/ International. Symposiums for New Energy and he is familiar with the Russell work too. Space Energy Association, P.O. Box 11422, Clearwater FL 34616. Phone/ Fax 813-461-7119.

*New Energy News* is the newsletter from the Institute for New Energy. It is a collection of reports on inventions, ideas and of publications relating to alternate and free energy. Monthly free to members with member fee of \$35 and \$60/yr. to corporations, libraries and universities. Hal Fox Editor, P.O. Box 58639, Salt Lake City, UT 84158-8639. Phone 801-583-6232 Fax 583-2963.

The *Planetary Association for Clean Energy* newsletter publishes articles to facilitate the development of a wide range of clean energy technologies including free energy technologies. Usually quarterly \$35/yr. Canada, \$40 USA, \$45 elsewhere. Andrew Michrowski, editor, Planetary Assoc. for Clean Energy, Inc. 100 Bronson Ave. Suite 1001, Ottawa, Ontario, Canada K1R 6G8. Phone 613-236-6265 Fax 235-5876.

### INVESTMENT/INTL. POLITICS/ ETC.

*The Reaper*. 36 issues per publishing year. I year- \$195. 10 issue trial - \$60. *The Reaper* is a no holds barred newsletter examining our current global and national economic/political status with an eye towards assisting investors in commodities, currencies, real estate, etc., etc. Publisher R.E. McMaster Jr.

is an acquaintance of mine who I introduced to the Russell's work and I have subscribed to his NL off and on over many years - not because I am an investor ( I should be and if I would have followed much of his advice would have made some cash, but I'm too involved in other work), but because I have been fascinated with R.E.'s analysis of our world situation. Called the Indiana Jones of the Christian economists by some he has a 'Christian' point of view but it is not conventional in my estimation. He is aware of new energy and natural health/healing practices and reports on these areas at times. P.O. Box 84901, Phoenix, AZ 85071. Phone 800-528-0559.

### EARTH CHANGES/ESOTERIC

*The Earth Changes Report* 12 issues/yr. \$36; Canada, Mexico, Alaska & Hawaii \$46/yr.; \$56/yr. elsewhere. Published by futurist/psychic predictor Gordon Michael Scallion gives Gordon's psychic predictions and a review of his hits and misses as well as articles in the new age spiritual genre and a report of earthquake, climate changes, etc. worldwide. I have watched Gordon Michael's predictions for the last several years and while he is not 100% on target he has been close enough on enough times to be much more than just coincidence. Published in the spirit of better to be prepared for what does or does not happen than to be unprepared for what does happen, the ECR is a good monthly review of earth changes as they happen and of what might happen beyond most folks wildest dreams - both pro and con. Matrix Institute, P.O. Box 336, Chesterfield, NH 03443. Phone 1-800-628-7493.

### ESOTERIC/NEW SCIENCE

*New Science News*

published by the International Association for New Science (IANS) addresses metaphysical and esoteric perspectives on pro-social topics such as sociopolitical, new age, and new science concepts. I have spoken at several of their conferences on the Russell's work as well as alternative healing topics. Quarterly, \$35 membership. Bear Jack Gebhardt, editor, IANS, 1304 South College Ave., Ft. Collins, CO 80524

### KEELYNET NEWSLETTER/INFO EXCHANGE

P.O. Box 870716, Mesquite, Texas 75187

Subscription price unknown - Published Quarterly - Info on new energy science and health information exchanges. The publisher is Jerry Decker a long time Russell student, Keely student and investigator into all kinds of unusual phenomena.

### RATBAG ANTIPHYSIC NEWSLETTER.

New Energy Science, anti-establishment news. Subscription price unknown. The publisher goes by the name of Millenium Twain, Plasmatronics Inc., P.O. Box E, Menlo Park, CA 94026

*Journal Of New Energy* published by the Fusion Information Center, P. O. Box 58639, Salt Lake City, Utah 84158-0638. A quarterly Journal subscription: \$150. Single Issues: \$45. This is a journal of the Institute of New Energy. It has published the papers presented at the first and second low energy nuclear reactions conferences held at College Station, Texas at Texas A&M University. This journal is top quality work presented by some of the leading thinkers and researchers in the field of new energy.

*Economics In Action* published by The Institute Of Ecolonomics Box 257, Ridgeway, CO 81432. A bi-monthly newsletter. A years subscription is \$35. It details the efforts of the Institute to transform our planet through business based on sound ecological principles. Articles on new energy, education, and any area of technology and commerce that can positively effect our lives may be published.

ADVERTISEMENT

The Fusion Information Center is pleased to announce its appointment as an authorized distributor for the **Cincinnati Group's Low-Energy Nuclear Transmutation Kit**.

**BECOME ONE OF THE WORLD'S  
FIRST TRANSMUTATION EXPERTS**

Being heralded as "The scientific-discovery that will change the world!" the production and marketing of the **RADIOACTIVE REMEDIATION KIT – LENT-1** ushers in the scientific **paradigm shift** that has been forecast by many new-energy experts. The purchase and use of this kit is the first important step for your company to become a leader in transmutation energy in the New-Energy Age.

Here is what you get with the **LENT-1 KIT**:

1. Specially machined, Closed-cell, Zirconium **Electrolyte Chamber**
2. The **Trenergy Power Supply**.
3. Complete Instructional Manual.
4. Access to experienced transmutation personnel for technical assistance.
5. Full year's subscription to *Infinite Energy*, *New Energy News*, and *Journal of New Energy*. These publications will be the leading source of additional information about the latest new developments in this exciting science.
6. A money-back guarantee if this equipment cannot transmute selected elements under proper operation.

**You can attain a new profession for less than the cost of a used car or a week's special technical seminar.** Your company can become a new-energy leader. Each person and each company has three choices for this new technology:

**Fight it. Ignore it. Lead it.**

**LEADERS:** Please phone, write, or fax for price and delivery information.

**INVESTORS:** Opportunities exist for qualified investors. Phone for offering memorandum.

For price and delivery information about the **LENT - 1 KIT** call fax or write to **TRANSMUTATION KIT C/O Russell Science Research team, Dr. Timothy A Binder Box 520 Waynesboro VA 22980 voice 540-942-5161 Fax 540-942 -8705** International customers may also request information by email:usp@rica.net

# *In The Wave Lies The Secret Of Creation*

by Dr. Timothy A Binder

This soft cover treatise on the Russell Cosmogony with 44 color charts, 10 black & white charts and 31 diagrams is now available. The book presents a Universal Systems Model that is applied to language in order to facilitate greater comprehension of the Russell Cosmogony. A comparison of Russellian Science and the Science of his time is given as is a description of the chief elements of the Cosmogony including: the eighteen dimensions, formula of the locked potentials, wave mechanics, the cube and the sphere, periodic charts, thermodynamic laws, and Newton's first and third laws versus the Russell Cosmogony to give a firm basis to understand Walter Russell's scientific paintings and charts.

An analysis of the paintings and charts comprises the second half of the book. Most of the paintings included in this volume have never before been published. The cover of this issue of *Fulcrum* has one of these paintings as its front cover piece.

Cost is \$35 plus \$3 postage within the USA. Phone 1-800- 882- LOVE to order your copy today!

### **Subscription and Back Issues Information**

An annual subscription to *FULCRUM*, published 3 times a year, is \$25 postpaid in the USA, \$30 Canada and \$35 elsewhere. Back issues are available at \$9 an issue.

#### **READERS,**

We will send a sample copy of any issue of *FULCRUM* to interested individuals who are not a subscriber; simply mail us your name, address and the number of the issue you would like us to share. Now is the time for God's science of creation to move into human consciousness. Thanks for your support!

Name: \_\_\_\_\_

Street: \_\_\_\_\_

City, State, ZIP: \_\_\_\_\_

Phone: \_\_\_\_\_

Enclosed for *FULCRUM*:

\_\_\_\_\_ Back Issues @ \$9 each – Vol. #(s) \_\_\_\_\_ \* \_\_\_\_\_ 1 year (3 issues) \$25

**Send to:** *FULCRUM*, Science Journal  
University of Science & Philosophy  
P.O. Box 520  
Waynesboro, VA 22980.  
Phone #: (540) 942-5161

Fax# (540) 942-8705

Orders: (800) 882-LOVE