

FULCRUM

Copyright 1997

*The Science Journal of
The University Of Science And Philosophy*

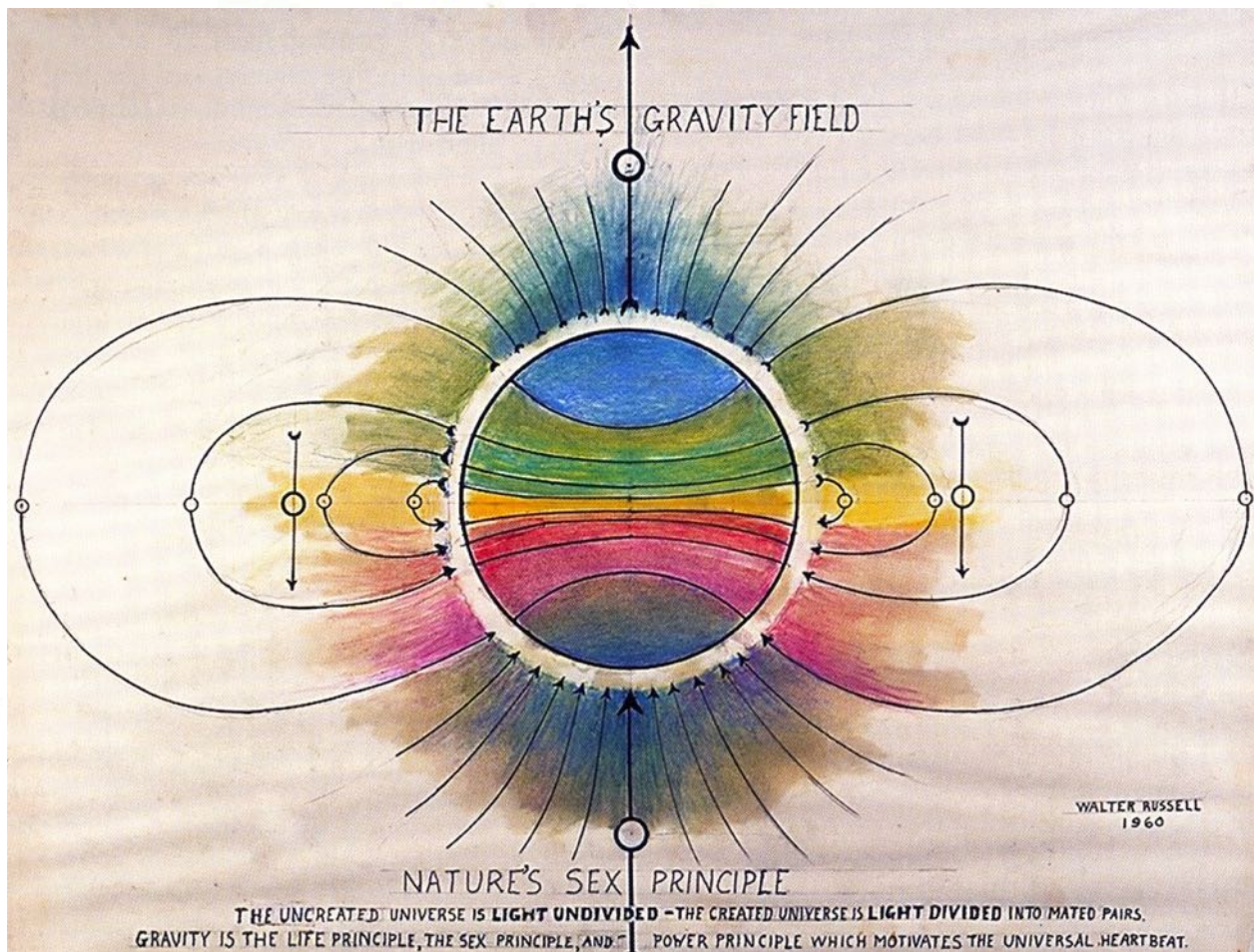

The cover painting & description following both copied from "In the Wave Lies the Secret of Creation."

The Earth's Gravity Field: Nature's Sex Principle

This painting of the earth and its gravity field shows the polar sex opposites with their respective color spectrums: blue-green female on the top and orange-red male on the bottom.

What is both curious and amazing about this painting is the way Dr. Russell has depicted the charging and discharging poles in relation to the rest of the field. This is the only instance where he used this type of illustration for the earth's gravity field. In every other case, both charging poles enter from opposite sides as head-on centripetal spirals directed toward each other with the discharging centrifugal spiral field exiting at planes of 90 degrees or less to the axis of the charging poles as it fans out to form the ecliptic plane. In this case he has a charging pole (here singular, where in all other instances there are two) on the red-orange male side and the discharging pole on the blue-green female side. See the following painting of the sun, Figure 42, as an example of his usual illustration of the male charge and the female discharge.

This painting emphasizes the polarity predominance of the male as charging or centripetally directed toward the center of the system and the female predominance as discharging or centrifugally directed toward the periphery of the system. It is much like his earlier descriptions in *The Universal One* where he identified female with discharge and male with charge more as pure types.

The painting is titled *The Earth's Gravity Field and Nature's Sex Principle*. As the title indicated, this painting symbolizes the essence of male and female as pure abstract types. In other words, this painting is unlike his other charts and paintings where the earth's field is accurately depicted with the two charging poles at the north and south polar caps and the discharging east-west poles at the equatorial expansion rim.

The Russell Cosmogony verifies that both charging and discharging poles have their opposite within them in varying degrees. The north and south poles have

maximum charge and a minimum of discharge at the polar axis, while the equatorial rim east-west pole has maximum discharge and a minimum of charge. The incidence of the opposite force increases in proportion to the distance from the polar axis or equatorial rim.

In this illustration of abstract male and abstract female as pure types, Dr. Russell revealed the secret for a new transportation device or an engine. The net effect of polarizing the field of the earth or any body as shown is to move it through its surrounding medium in the direction of the arrows pointing to the top of the painting. This direction would be as close to linear as possible in a universe where there is no linear motion. The surrounding medium (water, air, even ether) moves in the direction of the downward pointing arrows. Acceleration in this abstraction approaches infinity.

In *The Secret of Light* Dr. Russell said,
*The uncreated universe
is light undivided.*

which could be symbolized by either a uniformly black or white canvas. Furthermore he said,

*The created universe is
light divided into mated
pairs.*

This further draws our attention to the fact that he is symbolizing the "light divided into mated pairs" as pure abstract types.

His statement,

*Gravity is the life principle, the
sex principle, and the power
principle which motivates the
universal heartbeat.*

should alert us that Figure 41 is an abstract model for all engines and all transportation devices as well as the model for all motion. It is in essence a lever, albeit a continuous lever, in motion.

Table of Contents

Dialogue

Questions for the next issue	pg. 1
Responses to previous questions	pgs. 1-9
Some of the featured articles for the next issue	pg. 1
Letters to the editor	pgs. 9
Notice about the Lent 1 Reactor Kit	pgs. 19

Featured articles

Part two of Mechanism of low temperature transmutation by G. Rabzi of the Ukrainian Academy of Original Ideas	pgs. 20-27
The Great Pyramid, octave twelve tone chromatic scale, sinusoidal standing wave and squaring the circle in light of the Russell Cosmogony with implications for energy production by David Levick and Timothy A Binder	pgs. 28-37
Explanations of dimensional equations detailing that all phenomena are the same phenomena; or a unification of heat (temperature), Gravity, electricity/magnetism and Light with an accompanying geometry by Timothy A Binder	pgs. 37-45
The Ohsawa-Kushi transmutations by Robert Nelson of Rex Research	pgs. 46-52

From the archives

Letter from Lao Russell to Dr. Claude Gilmore Walker, National Capital Astronomers Jan.7, 1956 regarding the dangers of using "reasoning of the senses to help upliftto higher pinnacles..." after an illumination.	pgs. 53-63
Letter from Walter and Lao Russell to Robert concerning "perfect radar". June 8, 1961	pgs. 64-68

Patent papers

Fuel for internal combustion engines ; Apparatus for electrolysis; and process of making gas --(patents having to do with hydrogen fuel and methods of gas formation)	pgs. 69-77
Some of our current state (+&-) almost a half century after publication of The World Crisis, Atomic Suicide?, etc	pgs. 78&79

Newsletters/Periodicals	pgs. 80&81
-------------------------------	------------

Dialogue: Questions for the Next Issue

Questions:

- 1) How does carbon exhibit both cube and sphere geometry & at the same time?
- 2) Do the other elements and isotopes (half tones) exhibit more than one geometry and why?

Some of the featured articles for the next issue

Part Two of Explanations of dimensional equations detailing that all phenomena are the same phenomena; or a unification of heat, Gravity, electricity/ magnetism and Light with an accompanying geometry by Timothy A Binder

Transmutations of Ores by Robert Nelson of Rex Research

Visions of the Future - Prophecy & Divination by Timothy A Binder

Dialogue: Responses to Previous Questions

Questions:

- 1) What were the original EM equations of James Clerk Maxwell? Is there a missing element in the equations as taught today? Is this missing element called quaternions, and might that give the scalar component that could show the relationship between gravity and EM phenomena? How would the Russell Cosmogony interpret this?
- 2) What did Walter Russell mean when he said that during his illumination he realized "the sensed electric wave universe had no reality whatsoever"? How do you live with what this means to you or how does it affect your life?
- 3) What are some references for investigating the ancient science of prophecy as per James Afflecks' request this issues' letters to the editor?

Question #1 What were Maxwell's original equations?

Maxwell's equations

The four equations of electromagnetism completed by J. C. Maxwell in 1864. The equations govern a wide range of phenomena, including much of electronic technology. However, some modern technology requires the quantum-mechanical interpretation of the equations. In their most general form, Eqs. (1)-(4) relate four field quantities, the electric field **E**, mag-

$$\nabla \times \mathbf{E} = -\frac{\partial \mathbf{B}}{\partial t}$$

$$\nabla \times \mathbf{H} = \mathbf{J} + \frac{\partial \mathbf{D}}{\partial t}$$

$$\nabla \cdot \mathbf{B} = 0$$

$$\nabla \cdot \mathbf{D} = \rho$$

netic induction **B**, magnetic field **H**, and the electric displacement **D**, to the free charge and current densities ρ and **J**. Two auxiliary equations are needed. Microscopic displacements between bound positive and negative charges produce fields on a macroscopic scale when the displacements are the same throughout a macroscopic volume of material.

(B) Is there a missing element? Seems there was. Lorentz, Coulomb, Ampere, Faraday and quantum mechanics have added to, changed or amplified these four equations.

(C) Is the missing element quaternions? A quaternion is the quotient (product of division) of two vectors (directed lines in space). Quaternions originated in 1843. "It is a specialized form of algebra which in some cases offers a clear advantage over vector analysis." I have no idea whether Maxwell used it or not.

(D) Could a scalar component show the relationship between gravity and EM theory? I don't know.

(E) How would Russell interpret this? I assume your question is about the relationship between electromagnetic radiations and gravity. They are opposites, each one-half of every cycle of two-way motion.

Science says there are four forces in nature: electromagnetic (a term for all possible vibrational frequencies including light, electricity, radio, x-ray and gamma rays), gravity, strong and weak atomic forces. Science also says there are three different wave forms: longitudinal, standing and transverse.

Russell says there is one force - compression and two electric-only, three-dimensional, spiral vortex wave motions, compression and its reaction, expansion. Water down a drain, smoke rising, waves curling, wind off airplane wings, planets orbiting and suns forming are all whirlpool spiral vortexes, as are your thoughts, "energy" off your hands, your blood cells, bone cells and every spiral cell and atom of all bodies. Matter is motion. All motion is curved. All curvature is spiral.

Compression against resistance causes curvature, creates heat, pressure and density, ie., matter. Like stretching a rubber band, compression is two-ways in opposite directions from a static state of rest. Matter, the two divided dynamic pressure states, like the rubber band, snaps back and disappears into the zero of rest automatically. Expansion back to zero is the reaction to divided compression.

Cold is the resistance. Our universe, our cosmos, our world is cold, absolute cold, -273 degrees centigrade cold, unbeliavably cold. Living in the cozy environment of our warm planet, protected by our thick blanket of atmosphere, we're not aware of this vast universal vacuum or absolute cold as we spin and orbit through it at thousands of miles an hour. Our sun is the generator that electrically heats

this solar system. If our sun went out, earth and all the planets of this solar family would quickly disappear back into the cold from which they were created. All "hot matter" wants to return to its resting place - cold. Everything does return over time. Heat is created as resistance to cold and returns to cold. **Cold is.** Pressure is created as resistance to the universal vacuum and returns to the static vacuum automatically. **The vacuum is.** Density is created as resistance to the vacuity of space and returns to the void of space automatically. **Space is.** Motion is created as resistance to stillness and returns to stillness. **Stillness is. Matter is compressed motion of heat, pressure and density** which will eventually return to the cold of space, its eternal womb and tomb. In Russell's words: "Cold generates, generation contracts, contraction heats. Heat radiates, radiation expands, expansion cools."

THE UNIVERSE IS ONE
OUR SENSING WORLD OF POLARITY IS A TWO-WAY UNIVERSE

The following pairs of words, plus many more pairs, all refer to polar opposites as hot and cold, the two extensions of the rubber band, the two ends of a teeter-totter, the male and female of all creating things. Popular connotation may denote many different meanings for these words. In Russell's cosmogony, all the words of each polarity mean exactly the same thing, referring to the same process or principle.

- | | | | |
|--------------------|---|--------------------|------------------------------|
| Force | - | Reaction | |
| Inhale | - | Exhale | |
| Creation | - | Destruction | |
| Life | - | Death | |
| Growth | - | Decay | |
| Generoactive | - | Radioactive | |
| Multiply Density | - | Multiply Vacuity | |
| Divide Vacuity | - | Divide Density | |
| Compression | - | Expansion | Charging - Discharging |
| Generation | - | Radiation | Condensing - Evaporating |
| Implosion* | - | Explosion | Integrating - Disintegrating |
| Fusion | - | Fission | Centripetal - Centrifugal |
| Gravitation | - | Levitation* | Alkaline - Acid |
| Positive principle | - | Negative principle | Male - Female |
| | | | principle principle |

* Words Russell didn't use.

It is easy to see from these polarities that science's gravity and strong atomic force fit under Life and Growth. Their electromagnetic radiations and weak atomic force are Death and Decay. They are opposites.

Question #3 Ancient science of prophecy? Seems to me prophecy is a gift rather than a science. Perhaps some of the psychics on the 900 hotlines have your answer.

Question #2 What did Russell mean, "Our everyday world has no reality whatsoever?" That's God's little secret.

The world and your body is a virtual reality. You are not a body with a consciousness. You are Consciousness, a speck of intense Light, imagining a body. The universe is Mind stuff, Cosmic Consciousness, imagining a cosmos. You, the Consciousness and the Cosmic Consciousness are One when you know you are One.

You are like a primitive person watching a movie for the very first time, thinking you are looking through a window at a real happening. You now understand a movie as light, film and screen. What you are destined to know is that what you believe to be your body and a material world is but a three dimensional holographic dramatic illusion of light, film and screen which is projected from you and appears before you, the Consciousness, on the screen of your mind. In essence, what you are, you're looking with and looking at. In reality, the world doesn't exist without you. Consciousness along exists.

Walter Russell's illumination into Cosmic Consciousness left him knowing clearly that man's three states of sleeping, dreaming and waking are all within one big dream. A dream is an illusion. As with a child having a nightmare, the cry and teachings of all Knowers of Reality is - Wake Up! How will you know your life is a dream? You won't until you wake up and see the dream as a dream. That is all that is necessary. Then Knowing replaces ignorance.

For an earnest truth seeker the message of illumination becomes the most important story ever told. "Seek Ye First" and "Be Still and Know" become commandments. Primitive man only needed to physically step behind the screen to learn and understand the unreality of the play of light and film, the illusion of motion. Truth seekers can only spiritually know Reality, the source of their own Light. What is beyond the screen of the mind can not be known with the mind. A dream can not know the cause of itself. The only hope is to wake up.

There are numerous teachers and gurus, paths and disciplines. All religions point the way. Meditation is to free the mind of thoughts. Yoga focuses and clarifies the mind. Zen breaks down the mind. A quiet life of introspection and integrity may be enough. Some dance, chant or work a trade. A single focus of mind brings more self awareness, self control and self surrender, leading to clarity of thought, purity of motive, integrity of action, a sanctified life. True spiritual teachings point to the One, the Light, to yourself as Consciousness. When the student is ready the teacher appears.

Are there benefits to enlightenment? Not really. Outwardly the state is unrecognizable. You still chop wood and carry water. Knowing the false as false is enough. Inwardly, perhaps, a humble heart, a reverence, thanksgiving, a sense of purpose. Knowing brings freedom from anxiety, a harmony; the release of fear, a joy; a sense of Oneness, compassion for all life; a spiritual maturity, the willingness to let go everything. Mental quietness releases an inner happiness, the pleasure of just being, now.

"THE GOAL OF MAN IS TO KNOW WHO AND WHAT
HE IS AND HIS PURPOSE ON EARTH."

In virtual reality putting on the head gear and some body sensors allows you to see, hear and touch a holographic illusion. Some day you'll slip into a full virtual reality suit for full body sensation, enabling you to travel and experience anything anywhere. What science doesn't understand, we each already have a full virtual reality suit. It's called our body.

In the morning, after a nights sleep, your brain/body begins "electrically sensing." You, the Consciousness, become aware of the body and an outer world of dense matter. All matter is only light in fast vibration. Your body is only light in fast vibration. The bed, room, house, world is only light in fast vibration. Your thoughts are light in vibration. All there is is vibration. The sensors of your body sense vibration. You, a seeming individual, call this waking up. You feel alive. You, the thought/feeling I AM, wrongly assume that you are now conscious and a few moments ago you were unconscious. What you call deep sleep was simply a dead battery. The computer went down. The screen of your mind, the screen which you, the Consciousness watch from the drivers seat in your head, the screen upon which you, the Light, project your light through the films of real and imagined memories, the screen upon which the whole universe emerges from a microdot inside your head, this screen just went blank. You call it deep sleep. The bodily five sensors stopped sending vibrational input, what you call feelings. The brain stopped storing vibrational patterns, what you call memories. The brain stopped associating and collating vibrations, what you call thinking. You were still there. You are pure Consciousness. You are the Life force within the body. You were just not aware of yourself as being conscious while the screen was blank and the body recharged. You never sleep. You are eternal.

When the body batteries are low, tiredness sets in resulting in light sleep. This low voltage state allows random pictures to appear on the screen of your mind. You call this dreaming, day or night. You recall a dream as you do a movie. It seemed real in the moment, unreal upon waking up. A dream is virtual reality. It appears as real but isn't.

Reality is normally defined as the waking state where you, the Consciousness, identify yourself as your body. I AM MY BODY is the hypnotic cry of mass humanity. Bodies go through the waking state almost automatically, robotically, sensing, feeling and reacting electrically to vibrational input. As a body you can go through your whole morning routine unaware of even which shoe you put on first. You may find yourself having driven several miles to work before you realize where you are and wonder how in the world you managed to safely get that far. As you drove your body reacted electrically and automatically to vibrational input and vibrational programming, while you, the Consciousness, were watching a different movie in your head. You may read a whole chapter in a book only to wake up and realize that you, the Consciousness, were somewhere else. It's called being out to lunch. It's called hypnosis. It's called virtual reality. It's called not being present. It's called being human. It's called the waking state. Perhaps it should be called the potential for waking state.

It's natural enough to call this waking state reality because there is a sense of self living in a tangible universe where each individual can communicate, produce and seemingly affect the whole. However, through the same electrical stimulation and software, computers and robots do almost the same thing. Do we call them awake? Are humans just being electrically stimulated through an outside will? Does survival of the body depend on conscious directional choice, or as in all lower species, just the non-thinking automatic reflexes of accumulated memory of purpose called instinct? Can we call the electrically sensing state of animals a waking state? What is free will? Are our personalities self chosen? How much power does one individual have in this wire-in sensory mode of living and being? Is this the only reality?

"THE EVOLUTION OF MAN IS FROM BODY SENSING TO MIND KNOWING."

Spiritual growth is an expanding awareness of consciousness. The child plays with it's toys. The mother, being present in consciousness, watches the child in mind knowing awareness. Like the child your consciousness shifts from sensation to sensation, from perception to perception, from idea to idea, from imaged images to imaged images in endless succession. You are always conscious of the images in the mind, but you are not aware of yourself as being conscious. Awareness is the direct insight into the whole of consciousness, the totality of the mind, cognizance of consciousness. This is mind knowing. Become interested in being interested, aware of being aware, giving attention to attention, conscious of oneself as the seer. Ultimately a state of pure awareness, pure being, pure knowing appears. It is recognizable as choiceless love.

Usually the major obstacle to spiritual growth is your personality, a collection of attitudes, beliefs, traits and behaviors. You live by memory and act by habit. Judging everything, likes and dislikes turn into a search for pleasure and avoidance of pain. Desires and fears dominate your intentions, warp your integrity, cloud your insight. Death haunts you. Life torments you. You feel a victim of circumstances, a slave of emotion. Your character betrays you. You feel helpless to change. Your ego fulfills you, its expression you seek. You find yourself laughing and crying, loving and hating, unaware that you are the creator, enjoyer and destroyer of all you perceive. You become attached to "this and that," labeling it "me and mine." The I AM becomes "I AM this and I AM that." You create a make-believe world for what you conceive yourself to be. The inevitable result is disappointment and suffering. The dream shatters. You feel estranged.

Inwardly you long for happiness, contentment, the opportunity to love and be loved. Unknowingly you long to return to yourself, to wake up to Reality. Your inner voice whispers guidance from time to time. You have moments of joy. You spend more time alone. You begin to seek inspiration. You seek truth. You seek to break through the mist of illusion, to know who you are, what you are, what is your purpose in life? Unknowingly you seek God for all seemingly divided things seek Oneness.

Walter Russell as all Masters before him and surely those to come wish nothing more than for mankind to "wake up" to their divinity, their Oneness with all that is, the realization of Self as Universal Self.

They know the first step is to consciously choose to break bad habits, change attitudes, shape your own character, for your character shapes your life.

Then remember what needs be remembered. You are Consciousness. You are the Chooser. You are the Master. You are ageless. You were never born and will never die. Your self-imagined, self-creating body is millions of years old, evolving through countless cycles of appearance and disappearance. As a tree re-emerges from its seed so another body will re-emerge from your soul, your seed, for you, the Consciousness, to manifest Life through. From amoeba to now you've been present, just not aware of it. Right now you are a Being of Light, just not aware of it. Right now you are a Master, just not aware of it. Right now you are One with God. Do you desire to be aware of it?

In the words of the One, transcribed by Walter Russell during his full Illumination into Cosmic Consciousness in 1921, copied from the opening to his book, The Secret of Light, a message.

"I am the Light; I alone AM.

"What I am thou art. Thou art the Light.
Thou art One with Me.

"Man may know me by desiring to know
Me.

"To know Me is to be Me. Through My
Light alone can man know me.

"Man is Light when he knoweth that he
is Light.

"Man is Me when he knoweth that he
is Me.

"All men will come to Me in due time,
but theirs is the agony of awaiting."

from the Divine Iliad

From Timothy

Question #1) I was unable to find Maxwell's original equations in any of the references I found including Maxwell's own books on matter and motion and a theory of electromagnetism. In a book titled *Physics In The Soviet Union* by A.S. Kompanayets the author had a chapter titled "The Electromagnetic Field. Maxwell's Equations." I also find no reference here to quaternions, but there are many references and equations detailing scalar potentials. I do not yet understand these equations and the meaning of the scalar potential as expressed in them but will continue to research this and publish what I find in future editions. My present understanding of a scalar potential is that potential quantity of "bound" energy that is created by two parallel currents traveling in opposite directions; and that as the electric and magnetic fields appear to disappear the scalar field appears detectable by interferometric measurements. A capacitor stores an electric charge and can be released when it is discharged and I sense some connection

ELECTRODYNAMICS (Part II)

The first pair:

$$\operatorname{rot} \mathbf{E} = -\frac{1}{c} \frac{\partial \mathbf{H}}{\partial t}, \quad (12.24)$$

$$\operatorname{div} \mathbf{H} = 0. \quad (12.25)$$

The second pair:

$$\operatorname{rot} \mathbf{H} = \frac{1}{c} \frac{\partial \mathbf{E}}{\partial t} + \frac{4\pi \mathbf{j}}{c}, \quad (12.26)$$

$$\operatorname{div} \mathbf{E} = 4\pi \rho. \quad (12.27)$$

In these equations we consider ρ and \mathbf{j} , i.e., the charge and current distributions in space, to be known. The unknowns, to be determined, are the fields \mathbf{E} and \mathbf{H} . Each of them has three components.

In spite of the fact that both pairs form, together, eight equations, only six of them are independent, according to the number of field components. Indeed the three components of each rotation are constrained by $\operatorname{div} \operatorname{rot} = 0$ and, hence, are not independent of one another.

Electromagnetic potentials. We can introduce new unknown quantities such that each equation will contain only one unknown. In this way the overall number of equations is reduced. These new quantities are called electromagnetic potentials.

We choose the potentials so that the first pair of Maxwell's equations are identically satisfied. In order to satisfy equation (12.25), it is sufficient to put

$$\mathbf{H} = \operatorname{rot} \mathbf{A}, \quad (12.28)$$

where \mathbf{A} is a vector called the *vector potential*. Then, according to (11.40), the divergence of \mathbf{H} will be equal to zero identically. We shall look for the electric field in the form:

$$\mathbf{E} = -\frac{1}{c} \frac{\partial \mathbf{A}}{\partial t} - \nabla \varphi, \quad (12.29)$$

where φ is a quantity called the *scalar potential*.

From (11.39) $\operatorname{rot} \nabla \varphi = 0$. Substituting (12.28) and (12.29) in (12.24), we obtain the identity.

The determinacy of potentials. The electromagnetic fields \mathbf{E} and \mathbf{H} are physically determinate quantities since, through them, the forces acting on charges and currents can be expressed. The fields are expressed in terms of potential derivatives. Therefore, potentials are determined only to the accuracy of the expressions that cancel in differentiation. These expressions should be chosen so that the potentials satisfy equations of the simplest form. We shall now find the most general potential transformation which does not change the fields.

From equation (12.28) it can be seen that if we add the gradient of any arbitrary function to the vector potential, the magnetic

perhaps between this and a scalar potential that is bound when current flows are positioned correctly and it must be able to be released too. Both are potential charges until released into a greater potential environment. My source for the statement that Maxwell's original equations had quaternions that were later removed is retired Colonel Tom Bearden the author of several books on new energy, Tesla's secrets and secret soviet scalar weaponry. I will send the current and last issues of Fulcrum to him in hopes that he will offer us more of an explanation to just what the original equations were and what a scalar potential is. I suspect that scalar potentials occur between the boundary walls of all phenomena; that all the action inside the cube/sphere geometry is scalar potential - in action - from an insiders' (inside the cube/sphere - bound potential) point of view. Following are copies of two pages from Kompanayets' book. In them are an equation defining a scalar potential as well as a couple of pairs of Maxwell's equations and more. Are there any other readers who can help with interpretations of this and answers to the question?

Sec. 12] THE ELECTROMAGNETIC FIELD. MAXWELL'S EQUATIONS

field will not change, since the rotation of a gradient is identically equal to zero. Putting

$$\mathbf{A} = \mathbf{A}' + \nabla f(x, y, z, t), \quad (12.30)$$

we see that the magnetic field, expressed in terms of such a modified potential, remains unchanged:

$$\mathbf{H} = \operatorname{rot} \mathbf{A} = \operatorname{rot} \mathbf{A}'.$$

In order that the addition of ∇f should not affect the electric field, we must also change the scalar potential:

$$\varphi = \varphi' - \frac{1}{c} \frac{\partial f}{\partial t}, \quad (12.31)$$

where f is the same function as in (12.30). Then, for the electric field, we obtain

$$\begin{aligned} \mathbf{E} &= -\frac{1}{c} \frac{\partial \mathbf{A}}{\partial t} - \nabla \varphi = -\frac{1}{c} \frac{\partial \mathbf{A}'}{\partial t} - \frac{1}{c} \frac{\partial}{\partial t} \nabla f - \nabla \varphi' + \nabla \frac{1}{c} \frac{\partial f}{\partial t} = \\ &= -\frac{1}{c} \frac{\partial \mathbf{A}'}{\partial t} - \nabla \varphi'. \end{aligned}$$

Consequently, the electric field does not change either. Thus, the potentials are determined to the accuracy of the transformations (12.30), (12.31), which are called *gauge transformations*.

The Lorentz condition. Let us now choose an arbitrary function f such that the second pair of Maxwell's equations leads to equations for the potentials of the simplest possible form. Substituting (12.28) and (12.29) in (12.26) gives

$$\operatorname{rot} \operatorname{rot} \mathbf{A} = -\frac{1}{c^2} \frac{\partial^2 \mathbf{A}}{\partial t^2} - \frac{1}{c} \frac{\partial}{\partial t} \nabla \varphi + \frac{4\pi \mathbf{j}}{c}. \quad (12.32)$$

We express $\operatorname{rot} \operatorname{rot} \mathbf{A}$ with the aid of (11.42). Then (12.32) is reduced to the following form:

$$-\Delta \mathbf{A} + \frac{1}{c^2} \frac{\partial^2 \mathbf{A}}{\partial t^2} + \nabla \left(\operatorname{div} \mathbf{A} + \frac{1}{c} \frac{\partial \varphi}{\partial t} \right) = \frac{4\pi \mathbf{j}}{c}. \quad (12.33)$$

We shall now try to eliminate the quantity inside the brackets. We denote it, for brevity, by the letter a , and we perform the transformations (12.30) and (12.31) on the potentials. Then the quantity a is reduced to the form

$$a = \operatorname{div} \mathbf{A} + \frac{1}{c} \frac{\partial \varphi}{\partial t} = \operatorname{div} \mathbf{A}' + \frac{1}{c} \frac{\partial \varphi'}{\partial t} + \Delta f - \frac{1}{c^2} \frac{\partial^2 f}{\partial t^2}. \quad (12.34)$$

The function f has, so far, remained arbitrary. Let us now assume that it has been chosen so as to satisfy the equation

$$\Delta f - \frac{1}{c^2} \frac{\partial^2 f}{\partial t^2} = a. \quad (12.35)$$

Question #2) Lao Russell gives us an answer to this question in her letter to Dr. Claude Gilmore Walker in the Archives section and I believe all of the Russell work is an answer to this question. I think Larry's answer in "God's Little Secret" is another answer sufficient unto the day thereof.....so I don't really feel the need to try and add to the already bountiful harvest other than to say how my understanding of this affects my life. It focuses my awareness inwards even when I am working outwardly in the world. My awareness of the "unreality" of this transient thought wave universe "frees" me from it or "awakens" me to the extent that I know I am dreaming all of this. When I am intensely aware of reality even unreality becomes more vital and alive. Awareness of this creates the desire to be still and know - and at times with no effort like lightning zen "it" appears.

Question #3) I know of two prophetic sources supposedly based not on the "visions reported by "sensitive" minds", but those "derived from a knowledge of space /time geometrics". The first is that the pyramids and other ancient temples of Egypt are claimed by some to have encoded in their proportions and in their geometry prophesy even up to our present. There are old books by Isha Schwaller De Lubicz titled *The Opening Of The Way, a practical guide to the wisdom of ancient Egypt* and *The Temple In Man , the secrets of ancient Egypt* That show correspondences between these structures' geometry and the human body. The claim is that there is in pharonic Egypt, " geodetic, astronomical and physiological knowledge surpassing that which Egyptology has hitherto been able to concede". Another even older source is more to the point of Mr. Afflecks' quest in that the claim is the

Great Pyramid has encoded within its geometry and "teleois" proportions predictions for most of our history of the world up to present times. Brown Landone wrote a book about this titled "*Prophecies Of Melchi-Zedek In The Seven Temples*" The second source that I am aware of is that there are claims that the Mayan calendar is a space/time geometrics prophetic statement. I seem to remember that interpretations of it are that it ends about 2012 and that is supposed to be the end of this age. I do not know of any books that I can refer you to that detail how the calendar works, its code and how to interpret it, but if you search for books that deal with the Mayan calendar you may likely find something that does just that.

In the next issue I will be examining prophecy and divination. Walter and Lao Russell made predictions in their books and verbally to various students that I am aware of and I will discuss these as well as those of other ancient and modern prophets. What can you and I do about the future of the world, and what can we do about our own future?

Letters to the editor

I have E-Mail letters from Millennium Twain and a letter and materials that Sara Shannon author of *Diet For The Atomic Age* sent me that are included here. If any of you are interested in participating in the background radiation monitoring project contact me ASAP so that we might work on it. It requires buying a radalert device, recording measurements in your local area and sending them to someone I plan on bringing into the project who will compile all participants readings every two weeks and send them on to a man in Colorado who will post them on a web site. I will publish them in Fulcrum as well.



RADIATION MONITORING BY CITIZENS

Fulcrum readers - would you like to join in on a radioactivity monitoring project?

The summer of 1997 a handful of concerned citizens began writing down the readings they got with their RadAlert radiation monitor. A website was created and the readings posted there.

The Radalert monitor used picks up levels of cobalt-60 and cesium-137, both typically found in releases from nuclear power plants. They have radioactive lives of 100 and 600 years, respectively.

WE plan to take the reading daily during ten minutes. We feel that this ten minute reading will give sufficient indication of daily levels, tell us of any larger releases or accidents among the world's 400 nuclear power plants, and provide an overview of the gradual increase in ambient radioactivity world-wide. The readings would be sent into the website every two weeks.

An average or expected reading could be 10 or 12 counts per minute. Fall 1996 in Manhattan this was averaging about 15 cpm, and Fall 1997 about 16 cpm. The alarm is set to go off at 30 cpm. The area around Chernobyl was 2000cpm summer 1996.

The RadAlert is available from Earthpulse Press 888 690-1277 You can contact ---- for information on how to take the readings and where to send them by FAX or mail. or write Earthpulse Press PO Box 201393 Anchorage Alaska 99520 or go to their website www.earthpulse.com where you can also find Sara Shannon's book Diet for the Atomic Age which tells about nuclear power, radioactivity and radio-protective foods.

WE want to develop a world-wide monitoring group.

The website is being redesigned and the method of posting re-considered. To have a look at it go to www.radwatch.home.ml.org

The Radalert™

The Radalert™ is a device used to measure radioactivity and is designed to be carried in your pocket. It is simple to use, requiring only the throwing of a switch to determine levels of radioactivity in the vicinity of the device. The unit is useful for anyone working in the nuclear industry, living near a power plant or persons concerned about exposures to radiation after large accidents. The device is designed for simple use and requires no training. The current version is distributed by Earthpulse Press at \$295.00 shipped priority in the United States and \$310.00 internationally (Prices subject to change with the newest version releasing in

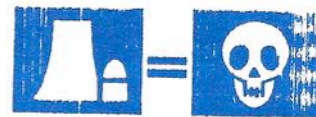

LOW-LEVEL RADIATION = HEALTH DAMAGE

The government-sponsored National Academy of Sciences stated in a report titled *Biological Effects of Radiation* (December 1989) that there is no safe level of radiation and this is because even the smallest amount causes free radicals. A number of independent researchers have demonstrated that long-term, relatively low levels of radiation may wreak up to 1,000 times more biological havoc than the currently accepted "risk levels" that are being used as reference points for decisions about licensing and operating nuclear plants.

In 1972, a researcher in Canada, Dr. Abram Petkau, found that when cells were irradiated slowly, a smaller total dose was needed to cause damage. Since this critical discovery it has been verified that a small dose of radiation over a long time is more damaging than one larger dose. Imagine the ramifications! This would mean that the small amounts of radiation that are released from the everyday operation of the world's 400 nuclear plants are doing much *more* damage than calculated.

This discovery, known as the "Petkau Effect," showed that the amounts of radiation that are legally released from nuclear power plants, combined with the leaks, spills, and accidents, are a cause of extreme damage to our health because continuous low-level exposures produce hundreds to thousands of times more free radicals than the same dose delivered at one time, as in an X ray, for example.

Dr. Ernest Sternglass, a pioneering researcher in the field of radiation health, explains in his 1978 book *Secret Fallout* the implications of this new understanding: "Doses of radiation delivered slowly and continuously over extended periods of time are hundreds of times as damaging biologically as short,



Use the Radalert™ to:

- Monitor personal radiation exposure
- Monitor an area or perimeter
- Detect radiation leaks and contamination
- Monitor changes in background radiation
- Demonstrate principles of nuclear physics
- Check for radioactive minerals in the earth

Features:

- Digital LCD Display
- Adjustable alert level
- Geiger Mueller detector
- Easy conversion to mR/hr for Cs 137
- Interface to a computer
- Long battery life

Earthpulse Press, Inc.
P.O. Box 201393
Anchorage, Alaska 99520 USA
Fax:907-696-1277
Voice Mail: 907-249-9111
Internet: <http://www.earthpulse.com>

high intensity exposures of the same total dose. This was made clear in 1972 by Dr. Abram Petkau who discovered that at low doses of radiation absorbed at low rates, the dominant biological damage is produced by highly toxic molecules called free radicals."

The everyday releases of radioactivity by nuclear power plants has been found to cause several kinds of health damage, including premature births, congenital defects, infant mortality, mental retardation, heart ailments, arthritis, diabetes, allergies, asthma, cancer, genetic damage, and chronic fatigue syndrome. It has been linked to previously unknown infectious diseases, and generally weakens the immune system. Radiation shortens the life span of most organisms, according to Denham Harman in *Free Radical Theory of Aging*. Even at low levels,

radiation may increase mutations of bacteria and viruses, as Andrei Sakharov described in his 1992 *Memoirs*.

A 1966 report by the Atomic Energy Commission produced findings that agree with the thoughts of Nobel Laureate Linus Pauling: "There are no safe amounts of radiation. Even small amounts do harm."

But humans evolved in an environment that contained naturally occurring radiation. So why is radiation so hazardous to us? The answer to this has to do with the *type* of radiation. Radon, which was always around, is known as alpha radiation. The particles cannot travel very far. Strontium-90, which is a man-made radiation, is a beta particle. It *can* travel far. So how does this affect us? Our bones are hollow inside, they have a space for the bone marrow. This is the place where the white blood cells, which are key operatives in the immune system, are made. Nature did a brilliant design here because the bone protected the delicate bone marrow from the then-prevalent type of radiation—alpha. Nature did not foresee that humans would come up with a type of radiation that did not suit its original design. Because beta particles can travel through bone, they are able to zap the white blood cells. What happens? We gradually have a more and more weakened immune system. What is the answer to this dilemma? This seems to be the question confronting humanity.

Nuclear power emissions reach you directly in the air and water—and through animals we eat that may be contaminated with radiation, since they, in turn, consume air, water, and food that is contaminated. Radiation contaminates rainwater. We eat crops irrigated with this water. We inhale the air. Emissions may go to the land, into runoff, and then into rivers. Water may also find its way to a reservoir from which we drink. We eat fish from contaminated rivers and lakes. Freshwater fish are more contaminated than ocean fish because the minerals in the ocean water stop absorption of radionuclides to some extent. Fresh water contains 100 to 1,000 times the amount of strontium-90 that ocean water contains (C.S. Clusek, Department of Energy Lab Report, EML-429, July 1984).

Low-level radiation gets into the air and water through releases from nuclear power plants (planned and accidental), leaks from nuclear waste sites, nuclear military installations, nuclear bomb tests, medical procedures, tobacco smoke, air travel, smoke detectors, and X rays.

ENERGY CONSERVATION AND ALTERNATIVES

The transition from a nuclear- and fossil-fuel-based energy to a renewable form is both necessary and doable. With a fraction of the funds put into nuclear power we could readily tap the available sources of energy that are sustainable, reliable, and competitive—and are also clean and safe. These include wind power, hydroelectric power, tidal power, biomass (wood), geothermal energy, solar thermal technology, solar power, and solar cells. (Consider, for instance, that we could meet the world's demand for energy if the state of Nevada was covered with solar cells.)

Conservation of energy is also key. Each person can do his part. Install double windows to conserve heat loss. Turn off the lights—half of electricity used for lighting is wasted. Use new refrigerators and other appliances that reduce energy consumption. Use new light bulbs that use one fourth of the energy. And these are just for starters.

“Nuclear power is life-threatening in three independent ways, each formidable. First, is the danger of accidents. Second, every nuclear reactor produces as a by-product plutonium-239, which is the most dangerous toxic substance known. Third, no one knows what to do with nuclear waste.”

—DR. GEORGE WALD, Nobel Laureate

“Health effects from low-level radiation include the induction of cancer, genetically determined ill-health, developmental abnormalities, and some degenerative diseases.”

—Nuclear Regulatory Commission Report, December 1989

“In 1975 there were 59 cases of Lyme Disease recorded; in 1985, the number increased to 863, mainly in the two counties of Middlesex and New London, Ct., near the Millstone Nuclear Power Plant. Just as increases in cancer may be linked to the huge radiation release from Millstone in 1975, so too may be the tick-borne Lyme Disease epidemic. The Lyme Disease is carried by a spirochete that had not been harmful to humans prior to 1975. It is well known that radiation can cause mutations in bacteria. The enormous 1975 Millstone radiation release may have caused just such a mutation in the tick-borne spirochete.

—JAY GOULD, Ph.D., *Deadly Deceit* (Four Walls Eight Windows, 1990)

“Recent studies have suggested that free radicals can stimulate the activation (and proliferation) of HIV.”

—C. SAPPEY et al. of the Grepo Laboratory in Grenoble, France, paper given at the VIII International Conference on AIDS, July 1992

“Contrary to widespread belief, nuclear power is no longer a cheap energy source. In fact, when the still unknown costs of radioactive waste and spent nuclear fuel management, decommissioning and perpetual care are finally included in the rate base, nuclear power may prove to be much more expensive than conventional energy sources, and not economically competitive with safe, renewable resource energy alternatives such as solar power.”

—*Nuclear Power Costs*, Report No. 95-1090, U.S. Government Printing Office, 1978

Multiplying twenty times its half-life gives a substance's full radioactive life. For example, strontium-90 with a half-life of 28 years will become stable, or not radioactive in 560 years. 28 years times 20 equals 560 years.

Looking at the following list gives one the inspiration to utilise the possibilities of transmutation which have been recently validated.

Half-Life of Selected Radionuclides Emitted by Nuclear Facilities Into the Air

“We propose that energy efficiency, conservation, and self-renewing sources such as sun, wind, and water be implemented globally as an alternate to nuclear power and fossil fuels.”

—A statement representing the wishes of all the world's women formulated at the Women's Congress in Miami, 1991

“No more than one or two decades remain before the chance to avert the threats we now confront will be lost and the prospects for humanity are immeasurably diminished. We, the undersigned senior members of the world's scientific community, hereby warn all of

humanity of what lies ahead. A great change in our stewardship of the Earth is required.”

—*Warning to Humanity*, issued by the Union of Concerned Scientists, 1992, signed by 1,500 scientists from 69 nations

Substance	Half-Life
Phosphorus-32	14.3 days
Phosphorus-33	25.0 days
Chromium-51	27.8 days
Manganese-54	303.0 days
Iron-55	2.6 years
Iron-59	45.1 days
Cobalt-58	71.3 days
Cobalt-60	5.3 years
Nickel-63	92.0 years
Niobium-92m	10.1 days
Tin-117m	14.0 days
Tungsten-185	75.8 days
Uranium-237	6.8 days
Krypton-85	10.8 years
Xenon 129m	8.0 days
Xenon 131m	11.8 days
Xenon 133	5.3 days
Iodine-129	1.7 x 10 ⁷ years
Iodine-131	8.1 days
Strontium-89	52.0 days
Strontium-90	28.1 years
Yttrium-91	58.8 days
Zirconium-95	65.0 days
Niobium-95	35.2 days
Ruthenium-103	39.6 days
Ruthenium-106	367.0 days
Tellurium-127m	109.0 days
Tellurium-129m	34.0 days
Cesium-134	2.1 years
Cesium-136	13.0 days
Cesium-137	30.2 years
Barium-140	12.8 days
Cerium-141	33.0 days
Cerium-144	284.9 days
Neodymium-147	11.1 days
Plutonium-239	24,400.0 years
Plutonium-240	6,580.0 years

Sources:

Selection of radionuclides from *Radiation Exposure to the Public from Radioactive Emissions of Nuclear Power Stations* by B. Franke, E. Kruger, and B. Steinhilber-Schwab of the Institute for Energy and Environmental Research, Heidelberg, West Germany. Used by permission.

Values for half-lives from *Handbook of Chemistry and Physics*, 63rd edition. Weast, Robert C., Ed. Boca Raton, FL: CRC Press, 1982.

Friday, 26 December 1997

World Friends,

Saw the southern cross last night (in person) for the first time. Slept out-of-doors in the bush, the owls ('moorporks') hooting all the time.

Last three weeks were extremely hectic. Suffice it to say that the burden fell on me to sort-out and relocate the new downsized DePalma Institute. I am now one of four trustees, and the executive director. Before year's end I will be sending out a personal message, re: the passing of Bruce DePalma, from his closest associate Andrew Mount. Andrew has returned to California, having received insufficient support in his bid for permanent residency in New Zealand.

I will also send out my own report -- wrapping up the activities of the old DePalma Institute, and outlining those of the new. [Our only current activity is the maintenance of a WebSite, and the proliferation of email discussions. Also, my continuation of the Global Aether Workshop collaboration I launched in Silicon Valley in 1997. Our first planned NEW activity is the launching of a global dissident physics journal in 1998, as soon as donation of a good quality copying machine or equivalent copy services can be secured.]

Finally, I will be sending out a SPECIAL announcement -- on New Year's Day 1998 -- launching a new consciousness/organization and hopefully ethos, designed to cope with the coming apocalypse (with or without rapture). Your personal feedback is anticipated, and will be much needed.

My new primary public email address is [muse@ethos.co.nz]. My secondary (backup, private) email address is [mtwain@ihug.co.nz]. take care,

Millennium Twain

"We are stardust,
we are golden ...

and we've got to get ourselves,
back to the garden ..."

* To be removed from this mailing list, just send me a note requesting same. To recommend others to this list, just send me their email address.

Sat, 22 Nov 1997 07:30:01 +1200

Amigos y Amigas,

My public email address, muse@mediacity.com, has been disconnected** for the last 4 days. No knowing how long that will continue. You may use my alternate, formerly private, address [ratbag@hughes.net] for any compelling or otherwise engaging communications ...

MT

** three weeks ago the wannabe 'Royal' Society of New Zealand complained to MediaCity.Com in California of my revelations of covert physics to the New Zealand physics community. [The text of this complaint was forwarded to me, and now resides at several secure locations around the globe.] MediaCity threatened to disconnect me, even though all my communications were correct and above-board (and generally receiving accolades from NZ recipients). Four days ago I sent out my famous overview of the historical truth of the Michelson-Morley-Miller experiments, the reasons why Germany made Einstein's nontheories the Western 'standard', and why Haisch (Lockheed) and Puthoff (CIA and NSA) are promoting the ZPF. An hour later my service in California was disconnected. 4 days and MediaCity has not responded to why, or reinstated my service.

My WebSite [mediacity.com/~muse] and everything on it has been erased, or has been blocked the last three days. Again, no word on this from Mediacity.

Tuesday, 25 November 1997

"All's well that end's well".

As of today, seven new World-Muse MIRROR sites have been started at locations in New Zealand, the Fascist States of Amerika, and elsewhere around the globe. In addition to my ratbag email address, and an unpublished private address, two new email pop accounts have also been set up for me -- in order to prevent further institutional attempts to silence me.

Persons wishing to post some or all of my dissident physics, or voluntaryist ethics and verse, should send a request to "ratbag@hughes.net". Similarly to request samples of my verse, or hardcopy of my papers, or share other activist links and email addresses.

Lastly, the offending email "Coup Deutsch" (on the fraud of 20th century Western physics) is being published in both electronic and hardcopy form in several places around the world.

to a world in harmony with nature,

Millennium

Barry,

Thanks for your friendly note. If you can suggest any email addresses, or Websites, or personal or organizational contacts I should make -- let me know at any time. Any activist or scientific or technically oriented folks.

Basically, in plain English, I have proven that the physics theories taught by nuclear and particle physics are wholly bogus. The reason that there are no working plasma fusion tokamaks in the world, after decades and billions of dollars spent, is that fusion in nature is NOT an explosive thermonuclear process. The Sun is not a big jar in which gas is heated to high temperatures, and subjected to high pressures -- and then random statistical collisions occur producing fusion.

Maxwell's (or Heaviside's) equations do NOT apply. Einstein's theories do NOT describe plasma processes, or any processes in nature. Light and matter (plasma) are not estranged partners, living in different universes, of separate origins. They are of the same pre-energetic (structure, vibration) origins. Light or electromagnetic waves are a particular frequency and structure of the aether -- of spin and propagation. Electrons and protons happen when particular frequencies and structures of light-aether superimpose or reconnect into rotating balls of light. Standing waves, or solitons, or particles to use the language.

Those wave travel at ALL velocities -- not simply one average velocity C , of 300,000 km/sec. Many many of the recorded velocities (for large and longitudinal waves in particular) are low frequency and velocity. Many (smaller and transverse, or spin) are near 300,000 km/sec. Many are superluminal, observed between $1.4C$ and $10C$, and perhaps at $100C$. These are generally the highest frequencies, smallest and most transverse (spin-composed) lightwaves.

For nuclear fusion, whether in the lab or Sun or Quasars, what this boils down to is we can now look at specific relationship and light and particle structures -- filamentary plasma trains and vortex structures -- which any child can draw or paint in school. Which ANY teacher or experimenter who speaks Cantonese or Italian or Maori can understand and communicate and fabricate. No need for lifetime indoctrination in the covert language of tensor analysis etc., or the military methodology and 'morality' of artillery and warheads.

Nature, fusion in the lab or stars, is NOT explosive or destructive. It is not an unknown statistical process of combat and collision. It is a one-on-one joining of lightwave to lightwave, or electron to electron, or proton to proton -- like one marathoner passing the baton to the next. It is being discussed and tested by several thousand dissident theorists and inventors around the world today -- people like Kanarev and Frolov in Russia, Illert and Hodges in Australia, Mills and Shoulders and Wolfe and several hundred others in the US, Xu et al in China, Assis et al in Brasil, Biberian and Vigier and many others in France, Japan, Germany, Canada. The list is growing at a rate impossible to keep up with.

There are thousands of references now available in the dissident self-published articles, books and journals -- and equal numbers of heretical references now in the standard journals. I have contributed

several myself, and can steer you to any number if you want to follow up. Perhaps more useful to you will be the many many webpages and websites (hundreds) devoted to these topics now online, or the specific characters (peerless genius individuals) who you can contact.

My personal work for the last eight years was simple and focused -- identify the specific complete structures of aether, light, electron, proton, neutron and the hydrogen atom. And support and nurture the unprecedented blossoming of an enormous global community of voluntaryist nonviolent natural philosophy. Persons with the ethical foundation and vision and persistence to work-out the theories, test the hardware, share the results, and stand forth before the world of combat and contest -- and say "enough!" We are bleeding. The world IS dying. Health and harmony is NOT a trend, a frivolity. It is a matter of life and death.

Our joy our artistry our economy CAN grow without measure. But is NOT a pie to be fought over and destroyed. She is a living breathing child of community -- and she requires love, and a song of harmony.

Millennium

let me know what I can do to help

Notice about the Lent 1 Transmutation Reactor Kit

Transmutation Lent 1 Reactor Kit information from Dr. Timothy A Binder to interested persons

I have had several inquiries from individuals interested in the Lent 1 reactor kit as advertised in the November 1997 Vol. 5 No.2 issue of *Fulcrum*. Following are answers to the questions I have received:

The Lent 1 reactor kit cost is \$3,000. If you are interested in pursuing research with the kit in transmuting radioactive elements into non-radioactive elements we suggest that you will also need the following equipment: 1) A two board multi channel analyzer for your PC. About \$4,000 .2) A PC with windows and at least a 486 CPU chip. \$1,000 to \$5,000 .3) A gamma -ray sensor. Sodium Iodide crystal at about \$1,000 or much better a germanium crystal with cryogenic cooling at about \$14,000 .4) Digital ammeter, voltmeter and temperature meters. Less than \$1,000.

Thus for a price tag of about \$10,000 to \$25,000 you can be equipped reasonably well to do low energy transmutations involving radioactive elements. If you are interested in pursuing the methods with non-radioactive elements you can skip the gamma ray sensor and simply rely on standard assays and other chemical or elemental analytical techniques not searching for radioactive phenomena. But, even in this scenario I would recommend that you do use instrumentation to verify if there are any gamma, x-

ray or radioactive emanations of any type coming from any transmutation experiment you might want to undertake. We are helping market this equipment and the concepts for the Cincinnati Group and the Fusion Information Center in SLC Utah. We all want to realize a solution to the radioactive waste nightmare that has been unleashed upon this planet. The Russell Science Research Team will be sharing our work with the kit in future editions of *Fulcrum* and will also be happy to share ideas, techniques and whatever assistance we can to those that purchase the Lent 1 kit through us. While reports about ongoing experiments and the equipment will be published in future editions of *Fulcrum* there are also available old reports in back issues of *New Energy News* and *The Journal Of New Energy*. Back issues will be made available to purchasers and you can talk to us and others that are working with the equipment, (a phone call is quicker and easier to respond to than a letter). The amounts of thorium used in the original experiments has been small (one tenth of a gram of thorium) . The amounts of byproducts of expected nuclear reactions must be measured in the parts per million; thus, to work with these amounts you will need the above mentioned equipment or can rely on chemical analytical techniques but they are very expensive.

We were the first to purchase a Lent 1 kit and it took us about two months to receive it. I estimate that the time to receive it will be at least half that now that we have received the first one. Please make checks payable to the Fusion Information Center and send them directly to Dr. Timothy A Binder C/O The University Of Science And Philosophy Box 520, Waynesboro VA 22980.

NATURAL COLD FISSION – NATURAL NEW ENERGY –
NATURAL NEW PHYSICS

Georgiy S. Rabzi¹

ABSTRACT

"Cold fusion" and "hot fusion" - are two antagonists whose uncompromising struggle will either produce new clean sources of cheap energy and help the world overstep the threshold of the third millennium under the banner of new physics, or prolong investing huge sums in tokamaks. The struggle takes place in your laboratories as well, when in your cold fusion test cells, you observe reaction products, such as elements, particles, and phenomena allegedly inherent solely in high-temperature nuclear reactions. Most often among these are tritium, helium, silver, chlorine, iron, excess energy, as well as protons and neutrons. The variety of cold fusion cells all have a joint in the armor: their structural materials and reacting substances therein are chosen arbitrarily. The attempts to understand the nature of the processes and the phenomena observed stem concomitantly from the results. We have heard about electrolysis, catalysis, chemical affinity, lattice-induced phenomena, and the like.

This author is absolutely positive and has abundant reproducible results to support the conviction that so-called "cold" and "hot" fusion phenomena are the outcome of radioactive-free low-temperature transmutation. In material objects this process is induced by their nature: presence of "-" and "+" electric charge fields which interact continuously with the spatial electric field. It is those interactions that govern all the processes both in the Universe and in our devices. This author's numerous experiments unambiguously suggest that controllable manipulation of the artificially intensified spatial field promotes transmutation.

INTRODUCTION

I invite you to join me in the mental experiment with the ordinary cold fusion test cell (Fig. 1). Let us bring it from its conventional upright position A through 90° into position B. In thus doing, under the same low temperatures you will witness the increased number of the reaction products owing to the summed up fields in the cell with the spatial field.

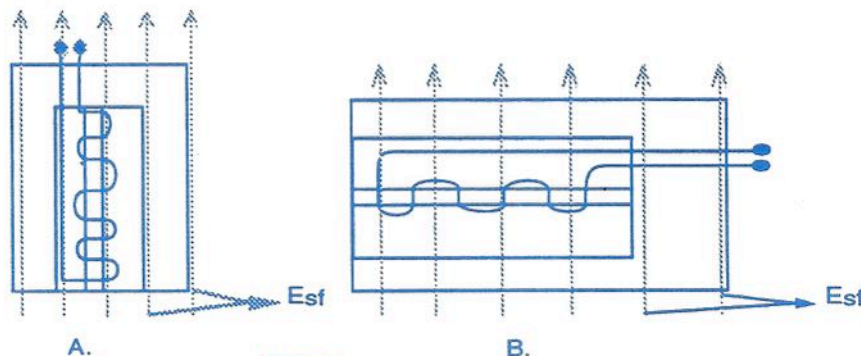

Fig. 1 Cold Fusion cell with spatial electric field (dotted lines).

¹ Ukrainian International Academy of Original Ideas, Southern Branch, Odessa, Ukraine

Numerous experiments in the likewise-arranged device substantiated an increase in the reaction products to the extent that I name the products as low-temperature transmutation (or fission), but not fusion. The results, along with the samples, were presented at the last-year conference [1].

The spatial field, ignored currently by the experimenters, exerts dramatic impact on every and all material objects. It provokes transmutation which takes place under different but necessarily low temperatures. Thus, at $T = 36.6^\circ \text{C}$ the spatial field interaction with carbon C^{13} in our bodies causes its decay into C^{12} signaling the human body's ageing [2].

Such a challenging statement cannot be trusted unless backed up with serious arguments. To these I shall proceed.

THE SPATIAL FIELD

The widely accepted fact that our Universe consists of positive and negative charges lacks one tiny detail: unanimity of opinions as to **what** are these charges. I will show later on that they can be only and exclusively electrons and positrons. So-called "elementary particles" known today - leptons, bosons, hyperons, and the like - are nothing more than the intermediate products of high-temperature bombardment of the nucleus. They have no natural stability, like electron and positron have. Electrons and positrons stand alone among over 300 elementary "ghost"-particles for their highest specific charges $\frac{e^-}{m_e}$ and $\frac{e^+}{m_e}$. They are unexterminable and fill the space at random. But their spatial distribution is never changed because an empty space is dielectric [3]. When interacting, electric fields of these charges sum up to form, respectively, spatial charges "+" of positrons and "-" of electrons. The space in between the charges is imbued with electric field lines self-emerged from numerous electron-positron pairs, or neutrinos. Their terminal charges $q_{v+} = 0.16 \cdot 10^{-42} \text{ C}$ and $q_{v-} = 0.16 \cdot 10^{-42} \text{ C}$ connect them, respectively, to the spatial "+" and "-" charges, and **in this manner the spatial material electric field is self-emerged**. It is in this field where all physical events with the objects of the Universe take place [4,5].

The charges of electron and positron are their uncognized essence, something called Logos in the Bible. *"In the beginning was the Word, and the Word was with God, and the Word was God"*. That is, these charges store and under interaction with the field give out all the information about any phenomenon: from gravitation to restructuring in lattices. Their interaction is primary. It is primordial, always the strongest, twin reciprocated. Self-attraction of charges yields self-motion of electron and positron. An oblate electron-positron pair = matter = neutrino is self-emerged [6,7,8]. Great velocity of attraction between those pairs is born, and energy is released when pairs collide (Fig. 2a).

THE NEUTRINO AS A BUILDING BLOCK

Being a particle of matter, a neutrino has both charge $q_{v\pm} = 0.16 \cdot 10^{-42} \text{ C}$ and mass $m_v = 0.43 \cdot 10^{-34} \text{ kg}$. Since q_{v-} and q_{v+} charges are unexterminable, hence mass is also unexterminable. Let me please remind you that I determine mass as a measure of the directional interaction between the nonexterminable electric charge and spatial field [1]. Therefore, a neutrino is not a hypothetic particle (as modern physics states) but real non-exterminable matter, the basis of the Universe.

From multiple neutrinos, through self-attraction of their microcharge fields, a neutron (n) is self-generated (Fig. 2b). It is further attracted to positron e^+ producing proton (p) (Fig. 2c). That is why **proton and neutron are essentially one and the same particle with only positron charge differing**.

The above considerations allow for explaining such a phenomenon as self-production of chemical elements in the Universe - from the simplest atom to transuranium ones - solely in terms of electron, positron, and neutrino charges.

ATOMIC FORMATION AND ATOMIC WEIGHTS

The spatial field polarizes the neutron-born proton. Neutrino in thus oriented field acquires spin $-1/2$ (Fig. 2d). Charge-conjugate interaction of all the neutrinos microcharge fields in neutron with all the anti-neutrinos in proton results in self-generated by mutual attraction a proton-neutron pair. All its charges are compensated, except for the positron charge captured by proton (Fig. 2e). An isolated positron in the atomic nucleus is impossible without simultaneously attracted electron, otherwise the system will not be an isolated one. Hence, according to the full charge conservation law [8] each proton's positron is joined by the attracted from space electron e^- decelerated by the spatial field force $F = e^- E_{\sigma}$.

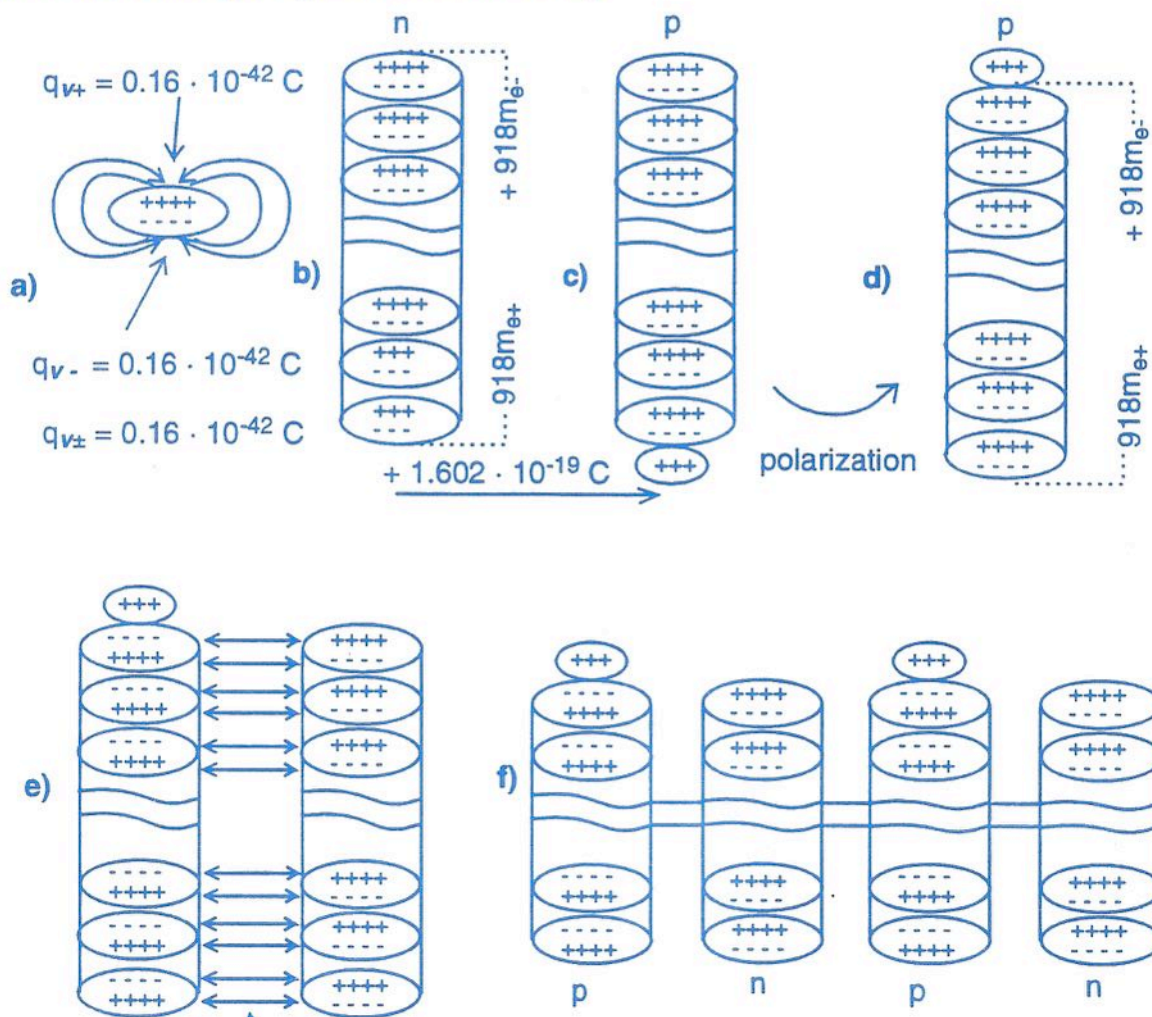

FIG. 2

Charge-conjugate self-attraction of the neutrons' microcharges in a neutron and anti-neutrinos in a proton

By analogy with the first p-n pair of an atom, interaction of conjugate charges involves the subsequent pairs whose orbital electrons correspond to the number of the nuclear positrons (Fig. 2f). In this manner self-formation of heavy and super-heavy (transuranium) elements proceeds **only** in those domains of space where low field intensity and about absolute zero temperature are found.

To verify applicability of the discussed theoretical sequence of the chemical atoms self-formation the **absolute atomic weights** of all 104 elements in the Periodic System were calculated using nothing else but electric charges of positron, electron, and neutrino. Absolute atomic weights 100% fitted the relative ones. The adopted model helped place hydrogen, as well as zero group (Table). Note that hydrogen is the first element to be self-generated and the pre-finite one in the complete decay. Calculations and analysis of the atomic masses corroborated the nuclei of all the elements (excluding isotopes) to consist of the differing number of *solely* proton-neutron pairs. Dineutron and diproton cannot inhabit nuclei because they are unstable, decaying in 10^{-21} seconds. [9]

Table I

Initial weight of the sample g	Input voltage (power source) V	Temperature °C	Duration h	Output current intensity obtained from Pb μ A	Output voltage obtained from Pb μ V	Final weight of the sample g
6.28	2000	780	6	81	139	6.6

My observations show instability to be inherent in all the elements of Periodic System and hence in all objects of the Universe. Instability is directly proportional to the number of the atomic orbital electrons. It is a new undeniable fact whose validity I claim, and insist upon, because nature in the research was identical to the nature of objects under study [13].

Self-generation of elements is accompanied with the release of energy into the space, which elevates its temperature. Energy is accepted also by orbital electrons at the moment of super-heavy elements formation. Weakly bound to the heavy element nucleus, electrons of the desired outer orbit, in their permanent interaction with spatial field, are stripped off the orbit, thus triggering low-temperature transmutation. Without a stripped off electron, its field-bound positron of the proton becomes exposed. According to the law of constant net electric charge of an isolated system (atom), the positron is forced off the proton by the spatial field. Self-emerged is the transmutation of the first proton-neutron pair into neutrino ν^+ and anti-neutrino ν^- . Fission of the first proton-neutron pair is completed when an isolated system (atom) is created, but of a lighter element.

TRANSMUTATION AND ENERGY

Transmutation of an atom involves continuously liberated radiation-free intra-nuclear energy. Released into the surrounding space are also orbital electrons, proton's positrons, certain number of neutrinos and anti-neutrinos as structural material for further self-generation of new elements. The processes of self-generation and transmutation of objects in the Universe are interconnected and proceed under low temperatures. It is by no means intermittent variations in the elements' behavior but a single, circular, continuous, and eternal process of universal transformations. Our Universe is constant in its dynamics, self-emerging and transmuting in a circle (Fig. 3).

Fig. 3 corroborates that both microworld and macroworld – the Universe – are equally based on interactions of charges e^+ , e^- , q_{ν^+} , q_{ν^-} . **The governing motive force that integrates the processes of self-emergence and self-transmutation of heavy elements into a single, strictly sequential, continuous circular process, which is a basis for vital activity of any**

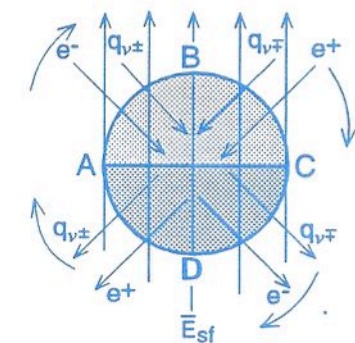

Fig. 3. A - self-emergence starts, decay of heavy elements stops; ABC - self-generation of heavy elements from e^+ , e^- , q_{ν^+} , q_{ν^-} charges; C - self generation stops, transmutation starts; CDA - transmutation of heavy elements into the final product (e^+ , e^- , q_{ν^+} , q_{ν^-}).

material object, is the low-temperature spatial field.

Fission involves liberation of energy which is partly utilized in fission of newly formed lighter elements whose binding energy exceeds that of heavy elements. Therefore, in order that further fission can proceed, elevated temperature is needed, but even in the Earth's core the temperature of fission never exceeds 5000°C . Tremendous temperatures in the central part of the Sun can be related merely to the huge (compared to Earth) mass of the decaying proton-neutron pairs.

Unexplainable bursts of temperatures up to the utter destruction of test cells [10] strongly suggest that, resulting from heating-induced low-temperature transmutation, a new element has self-emerged in the cell accompanied with the excess heat as by-product. Thus I claim that only and exclusively low-temperature transmutation provides a new source of cheap and ecology-friendly energy. And this is the basis for physics of the future.

Transmutation of super-heavy elements in their massive aggregations in the Universe always involves liberation both of energy and lighter elements, and their gaseous derivatives, like H_2 , He, CH_4 , NH_3 as the pre-finite stage of their finite transmutation into the charges e^+ , e^- , q_{vx} , q_{vz} . Electric charges are the products of transmutation, the very "dust" of which the Bible says: "For dust you are and to dust you will return." That is why numerous expensive attempts to fuse heavy long-lasting elements at temperatures as high as tens millions of degrees are hopeless. Violated by high temperatures and tremendous energies, Nature will never engender sound offspring, such as cheap abundant energy. New inexhaustible sources of non-polluting energy will be obtained by he who is utilizing the spatial field energy [4,5,11,12] along with the artificial combination of natural low-temperature self-generation of elements and transmutation processes.

During these days we can diversely use energy released during transmutation in bodies and substances. I have conceptual designs of the devices that:

- a) help utilize the energy of fission particles to obtain heat energy in the units made of pre-included constituent of heat-generating circuits for heat power plants;
- b) enable immediate production of electric energy as by-product of low-temperature transmutation.

To make the above statement valid, the experiments were initiated in February 1995 where Pb underwent transmutation at $T = 780^{\circ}\text{C}$ and standard barometric pressure. Reproducible results showed, besides new elements, microcurrents of electrons from the transmuting Pb.

The paradox of these results cannot but puzzle: transmutation of Pb destined to produce lighter elements induces an increase in the original weight of the sample. Analysis showed that the heaviest element in the Periodic System - osmium - is responsible for eight samples which support the above statement. These samples were handed at the last-year conference to Dr. G.H. Lin to be analyzed.

The discussed theory also gives clues to a number of urgent issues such as controllable enhancement of transmutation to process atomic wastes into commercially feasible non-radioactive products. It enables one to obtain long-lasting super-heavy elements. Following the above considerations, a device was constructed for accelerating and decelerating transmutation processes.

SUMMARY

The listed problems can be easily resolved if approached in terms of concepts introduced by my theory:

1. Nuclei of all elements consist exclusively of proton-neutron pairs.
2. Instability is inherent in all elements.
3. Transmutation proceeds under low temperatures only.
4. Self-generation and transmutation constitute a single continuous circular process of universal changes.

5. Spatial field of the electric charges is the basic factor which governs all the phenomena and transformations of material objects.

My report is supplemented with a tentative list of certain issues that can be understood and effected should the above concepts be accepted by Science. [see Addendum 1]

Let me please conclude with a wish that advent of the new millennium be marked with the advent of new energy and new physics.

REFERENCES

1. G.S. Rabzi, "Mechanism of Low Temperature Transmutation," *The Journal of New Energy*, (1996), vol 1, no 1, pg 46.
2. V.L. Kaznatcheev et al. Proc. Int'l Symp., "Cold Fusion and New Sources of Energy," Minsk, May 24-26, (1994), p. 190 (in Russian).
3. N.M. Mirolyubov et al. Methods of Calculating Electrostatic Fields, Moscow, Vysshaya Shkola Pub. (1963) (in Russian).
4. R.P. Feynman, R.B. Leighton, M. Sands, The Feynman Lectures on Physics. V.5. Electricity and Magnetism, Moscow. Mir Publ. (1966) (in Russian).
5. R.E. Peierls, The Laws of Nature, Moscow. (1959) (in Russian).
6. Fritjof Kapra. Dao of Physics, S.-Petersburg: Otis Publ. (1994) (in Russian).
7. K.N. Mukhin, Introduction to Nuclear Physics, Moscow. Atomizdat. (1968) (in Russian).
8. E.M. Purcell, Berkeley Physics Course. V.2. Electricity and Magnetism, Moscow. Nauka Publ. (1967) (in Russian).
9. Ya. Zeldovich, *Science and Life*, (1976). No. 10, p. 18 (in Russian).
10. E.F. Mallove, "An Italian Cold Fusion Hot Potato," *Cold Fusion*, May 1994, vol 1, no. 1, pp 45.
11. R.V. Pohl, Elektrizitatslehre, vol 2, Moscow, Fizmatgiz Publ., (1962) (in Russian).
12. C.L. Kervran, Transformation l'Energie du Faibles, Paris: Malon, (1975), 210 pp.
13. A.N. Vyal'sev, The Lightest Atomic Nuclei, Moscow, (1963), pg 54 (in Russian).

ADDENDUM 1**A List of Challenging Issues Which Are Met Adopting Conceptual Approach of
the Works by G.S. Rabzi,
"Mechanism of Low-Temperature Transmutation" and
"Natural Cold Fission -Natural New Energy - Natural New Physics"**

1. Physical essence of gravitation mechanism and zero gravity is disclosed. Twin paradox is explained.
2. Gravity in spacecrafts can be induced.
3. Possibility arises to determine neutron charge which provides for gravitational acceleration and magnetic moment.
4. Explanation is found for the physical essence of the Cavendish experiment on determining the γ constant in the Newton's gravity equation. It is interaction not of ball masses but of their dipoles.
5. Gravitating mass and inertial mass are proved not equal.
6. Four known types of interactions are proved to be the derivatives of the basic and unique interaction provided by Nature - charge, or electric one.
7. All sorts of interactions in the Universe can be described without introduced constants.
8. Elements' atomic size can be calculated without approximations.
9. Disclosed is the origin of $T_{1/2} = \text{const}$ half-life stability of elements and $\Delta m \approx 0.001$ mass defect stability.
10. Explanation is found for similar density of the nuclear matter in different atoms not related to the number of nucleons.
11. Understood is the cause of energy-radiating atom stability.
12. Mechanism of true (not averaged) energy quantum emergence is described without approximations.
13. True origin of "+" and "-" charges in the Dirac equation $E = \pm \sqrt{m_e c^2 + c^2 p^2}$ is shown.
14. Revealed is interference in the Michelson experiment and the resulting inconstancy of absolute velocity $C = 300.000$ km/sec.
15. Explained is the cause of light beam aberration from a star to the observer on the Earth.
16. Explanation is found for heavy ions to be retained at sufficient height from the Earth surface.
17. Found is the way to generate transuranium long-lasting elements.
18. Atomic nuclei can be constructed from nothing else but proton-neutron pairs; origin of the nucleons motion and their trajectories can be determined.

Mendeleev's Periodic System of Elements with Zero Group (in Grams)

Period	Row	Groups of Elements									
		0	I	II	III	IV	V	VI	VII	VIII	
1	I	H 1	Li 7	Be 9	B 10	C 12	N 14	O 16	F 19	Ne 20	
2	II	He 4	Li 7	Be 9	B 10	C 12	N 14	O 16	F 19	Ne 20	
3	III	He 4	Li 7	Be 9	B 10	C 12	N 14	O 16	F 19	Ne 20	
4	IV	He 4	Li 7	Be 9	B 10	C 12	N 14	O 16	F 19	Ne 20	
5	V	He 4	Li 7	Be 9	B 10	C 12	N 14	O 16	F 19	Ne 20	
6	VI	He 4	Li 7	Be 9	B 10	C 12	N 14	O 16	F 19	Ne 20	
7	VII	He 4	Li 7	Be 9	B 10	C 12	N 14	O 16	F 19	Ne 20	
8	VIII	He 4	Li 7	Be 9	B 10	C 12	N 14	O 16	F 19	Ne 20	
9	IX	He 4	Li 7	Be 9	B 10	C 12	N 14	O 16	F 19	Ne 20	
10	X	He 4	Li 7	Be 9	B 10	C 12	N 14	O 16	F 19	Ne 20	

Lanthanide Series

Ce 58	137.418	Pr 59	132.914	Nd 60	132.914	Pm 61	132.914	Sm 62	132.914	Eu 63	132.914	Gd 64	132.914	Tb 65	132.914	Tm 69	132.914	Yb 70	132.914	Lu 71	132.914
-------	---------	-------	---------	-------	---------	-------	---------	-------	---------	-------	---------	-------	---------	-------	---------	-------	---------	-------	---------	-------	---------

Actinide Series

Th 90	232.0377	Pa 91	231.03688	U 92	238.02891	Np 93	237.04817	Pu 94	239.05216	Am 95	243.06138	Cm 96	247.07125	Bk 97	247.07125	Cf 98	251.08180	Es 99	252.08395	Fm 100	257.10375	Md 101	258.10375	No 102	259.10375	Lr 103	260.10375
-------	----------	-------	-----------	------	-----------	-------	-----------	-------	-----------	-------	-----------	-------	-----------	-------	-----------	-------	-----------	-------	-----------	--------	-----------	--------	-----------	--------	-----------	--------	-----------

$\bar{\nu}$ - Electron-positron pair - Neutrino, with microcharge e^{-} - $0.16010^{-42}C$
 The absolute atomic weights of all the elements are multiplied by 10^{-4} grams

THE GREAT PYRAMID, OCTAVE 12 TONE CHROMATIC SCALE, SINUSOIDAL STANDING WAVE, and SQUARING THE CIRCLE in LIGHT of the RUSSELL COSMOGONY with IMPLICATIONS for ENERGY PRODUCTION by DAVID LEVICK and TIMOTHY A BINDER.

Imagine an energy generator that has no “moving parts”, produces no noxious exhaust nor requires fuel. In the free energy field there have been claims and suggestions of such devices for many years; such as T. Henry Morays’ device, Charlie Sweets and others. But, what if such a device had been used in ancient civilizations and its remnants are still here for us to observe if we have eyes to see? Many people have suggested the Great Pyramid was and/or is such a device although this has not been proven and engineered to any very practical degree that I'm aware of.

My long time friend David Levick suggests that this is the case and that he has had the eyes to see it where others although looking for and at it have not. David has been a friend for over twenty years since he first became this Doctors’ patient. Davids’ mother knew Lao Russell as David and his family hail from Richmond VA. Accordingly David was introduced to the Russells’ work years ago and first approached me with the ideas to be presented here over twenty years ago. Lao always said words like, ‘God does everything when it is its time to unfold’. We are unfolding our dreams and they may complete the Russells’ dreams to help birth the new technologies needed to balance and sustain the planet. We are in process of verifying the ideas outlined in this article and I hope it piques your curiosity and questions/answers.

The Russells were aware of the civilization of ancient Egypt and liberally quoted egyptologist James Henry Breasted about the ethics and religion of its people. They did not appear to consider the great pyramid these people built as embodying significant encoding about the structure of Gods’ Electric Light Wave Universe. Many other people have studied this amazing architecture and found what to them appears to be an incredible encoding of knowledge. There are claims and indeed apparently patents on devices inspired by the great pyramid claiming this geometry is some type of energy generator.

There is supposed to be a razor blade sharpener that if the blades are stored in a pyramid geometry they last for many more times than a blade not stored this way and other claims that the pyramid preserves foods and so forth. These devices and claims suggest that the Great Pyramid generates some type of energy that at least affects biological systems in that both the food preservation and razor blade sharpening effects work by inhibiting low forms of life, ie: bacteria that dull the blade edge by “eating it” and those that decompose foods.

Such a form of energy has been recognized by virtually all ancient civilizations and has been variously called Chi, Ki, Prana, Odic force, Orgone Energy, Life Force, Spirit and etc. It is energy that is obvious in living bodies, even if science can’t yet identify or capture it. Perhaps as many aboriginal peoples and the Russells suggested, it is actually in everything. Everything possesses spirit, everything has a life force, even a consciousness if you will, even if it is just an illusion of motion by the One Mind or One Consciousness, the Cause behind all transient phenomena.

OCTAVE / 12 TONE
CHROMATIC SCALE

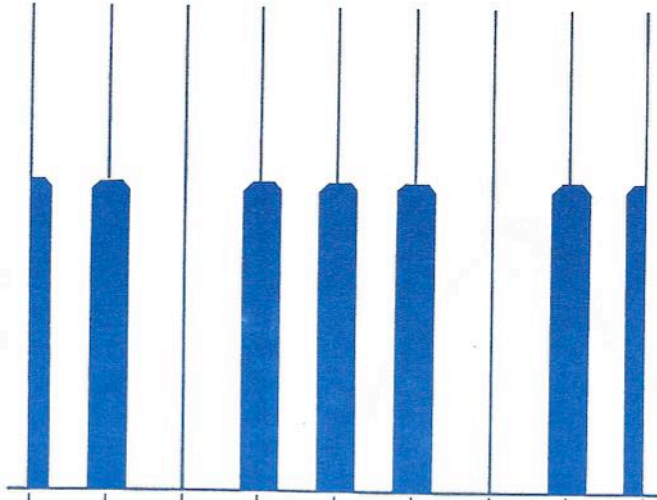

SINUSOIDAL
STANDING WAVE
ONE WAVELENGTH

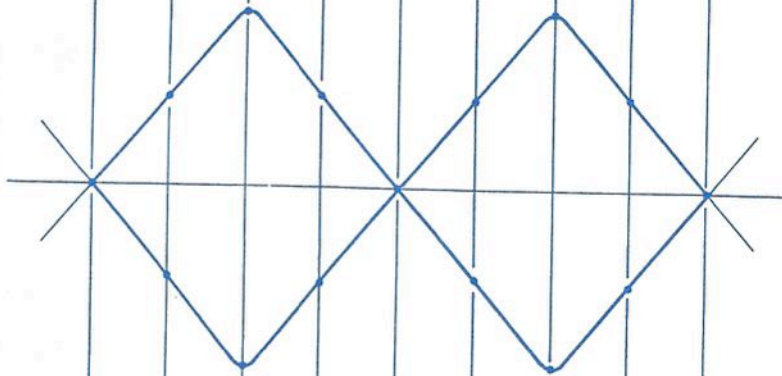

MATHEMATICALLY EXACT CROSS SECTION:
GREAT PYRAMID / EGYPT
THE BASE IS A SQUARE WHOSE PERIMETER
IS EQUAL TO THE CIRCUMFERENCE OF A
CIRCLE WHOSE RADIUS IS THE PYRAMID'S
HEIGHT.

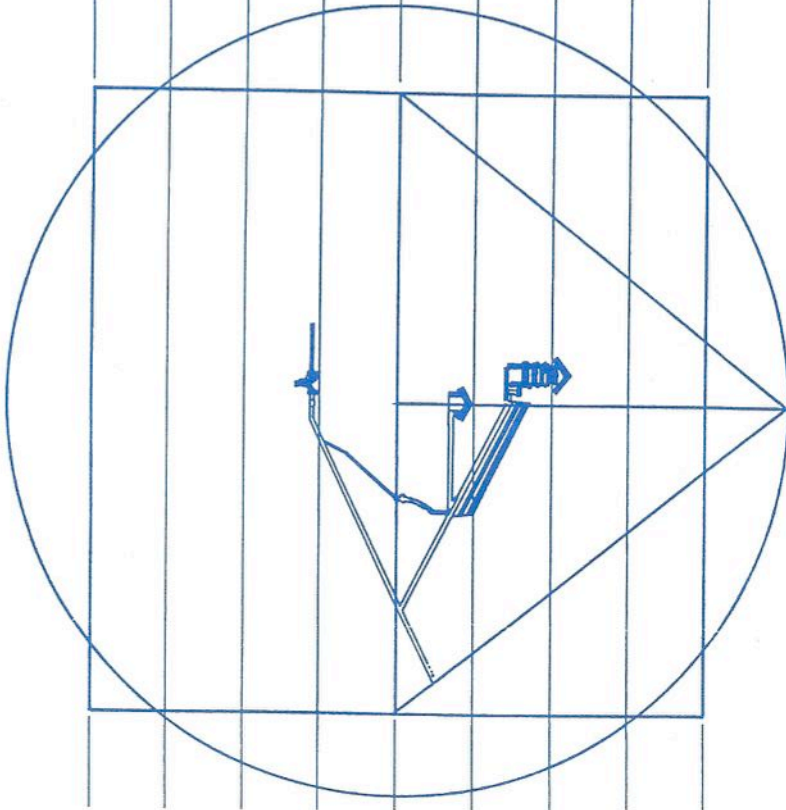

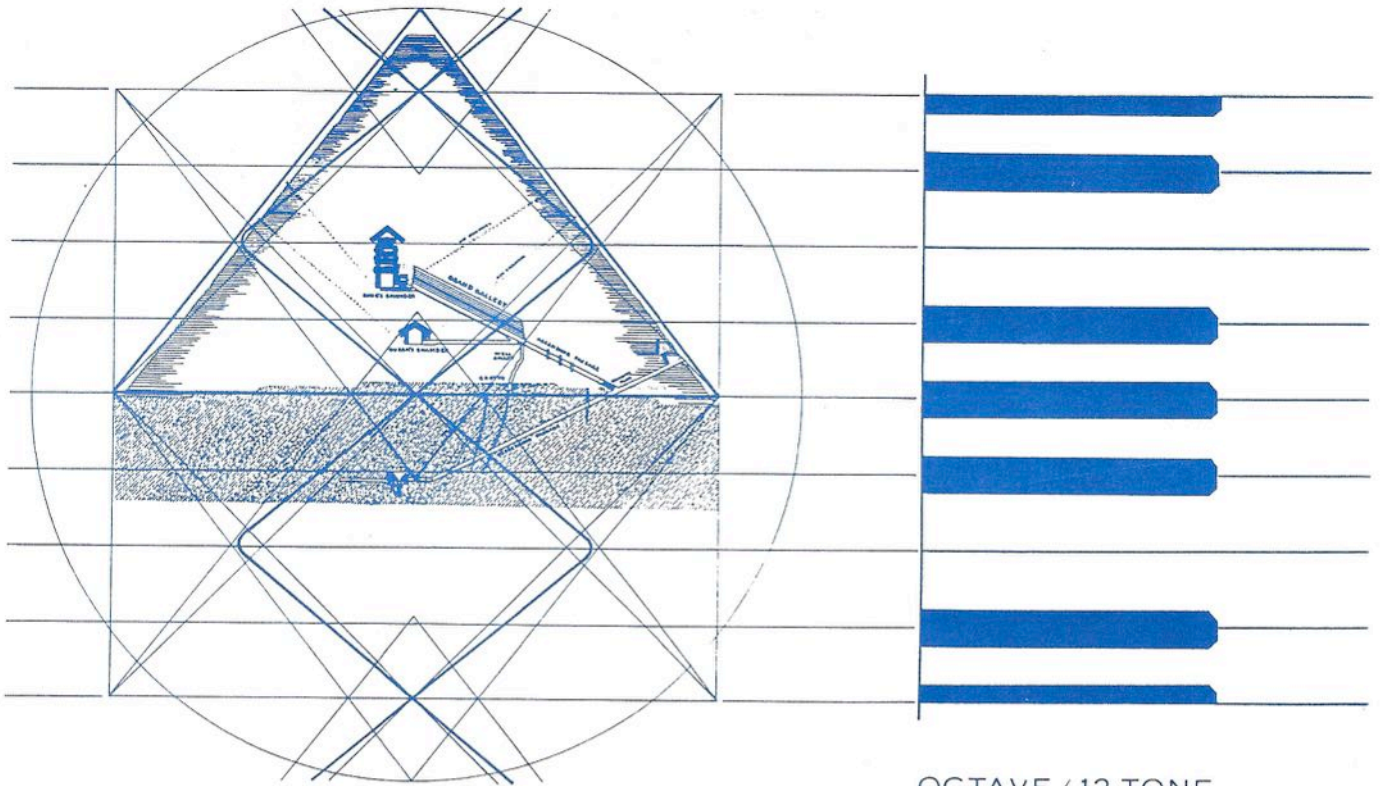

INTERNAL CONSTRUCTIONS AND STANDING WAVE SUPERIMPOSED ON EXPANDED PYRAMID GEOMETRY; INDICATING POSITION OF HARMONIC ANOMALY IN UPPER "CONSTRUCTION CHAMBER"

OCTAVE / 12 TONE
CHROMATIC SCALE

© DAVID LEVICK 1979

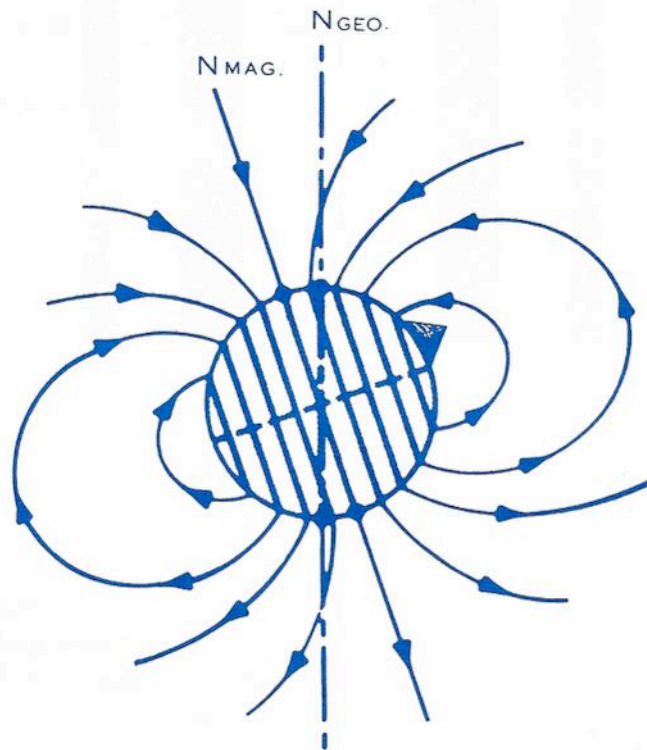

SIMPLIFIED DIAGRAM OF THE
MAGNETIC FIELD OF THE EARTH
AND RELATIVE LOCATION OF
PYRAMID (GIZA)

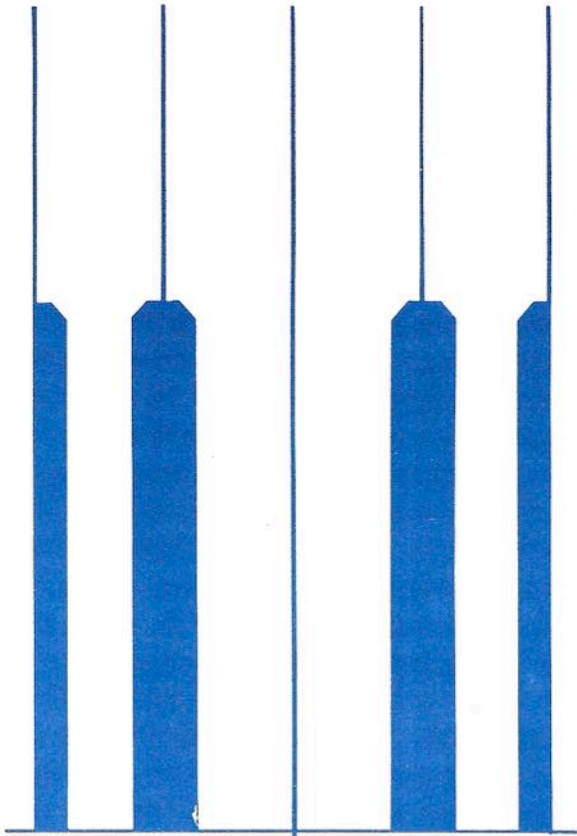

UNBLOCKED INTERVAL IN
CONSTRUCTION CHAMBER
EXACTLY CORRESPONDS TO
HARMONIC ANOMALY (D.I.S.
CONTINUITY OF VIBRATION)

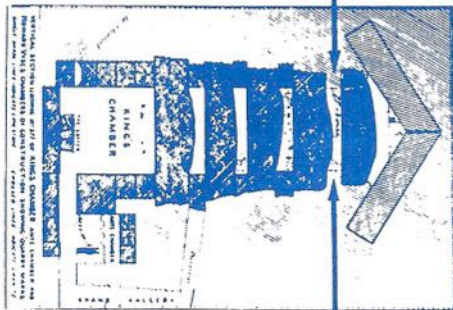

HORIZONTAL COMPONENT
OF GEO-MAGNETIC FLUX

It appears that such energy does exist; and although it is intimately related to Electromagnetic phenomena, or at least living bodies generate EM fields/currents, it appears to have other characteristics. Among these are: 1) It is possible to influence or direct it and to cultivate or nurture it by will and intention. 2) It is related to the state of health of an organism. 3) It is not blocked or shielded by the same substances or elements as EM fields are (what & why are questions that need to be answered for me). It is adversely influenced by fields and elements that are inimical to the existence of the organism producing the life force.

There are relationships between the various elements in the title of this article that we will examine that suggest the Great Pyramid may be a solid state energy generator, but in its present condition it is simply not fully on line, not tuned in and turned on.

Follow my discussion about Davids' diagram accompanying this article on pages 29 - 32 and you will see how some very interesting coincidences appear among these elements. First consider that the exact geometry of the Great pyramid is generated out of the two basic archetypes of Creation the Russells wrote about, the circle and the square or the cube/sphere. In squaring the circle we scribe a circle so that the circumference will equal the perimeter of the square so that $C=P$. Also the circle and the square share a common center. This is known as "squaring the circle". If we draw a side of the square through the common center and then a perpendicular to this that is a radius of the circle and join the squares' base end points to the radius we have scribed a cross section of the Great Pyramid. The radius of the circle is the height of the pyramid and the side/center line of the square is one of the pyramids' sides and the whole square is the dimensions of the pyramids' base. A side of the square is equal to the pyramids base.

If we complete some internal constructions by drawing in other pyramids in our squared circle diagram, there is one pyramid that when superimposed on our first pyramid assumes with the first a form of the star of David. This second pyramid we can consider as a virtual mate to the great pyramid as its apex is opposite the first. We could consider this construction as two interpenetrating male and female vortex spiral cones, or as coils. More about this consideration later. The base of this second virtual mate to the Great Pyramid has its base as the top side of the square in Davids' diagram. Its apex is very near the pit underneath the Great Pyramid.

Next lets place the octave 12 tone chromatic scale and a sinusoidal standing wave so that the wave and scale line up as in Davids' diagram. Here the scale and the wave line up so that the wave changes direction at the "missing half tone" (black key) in the scale. In Georges Gurdjieffs' system of thought all actions/ activity change at this place in their octave of growth unless energy is put in the system where it can continue its direction of growth. When energy is put in, Gurdjieff called it a shock, it creates now a new bigger wave which eventually in time comes to its point of reversal of direction; unless more energy or a shock is put in the system. This is illustrated in the following diagram of two wave forms with waves A, B & C in one and waves A & B in the other. The shock of energy must come in by, or at, amplitude point or the wave reverses.

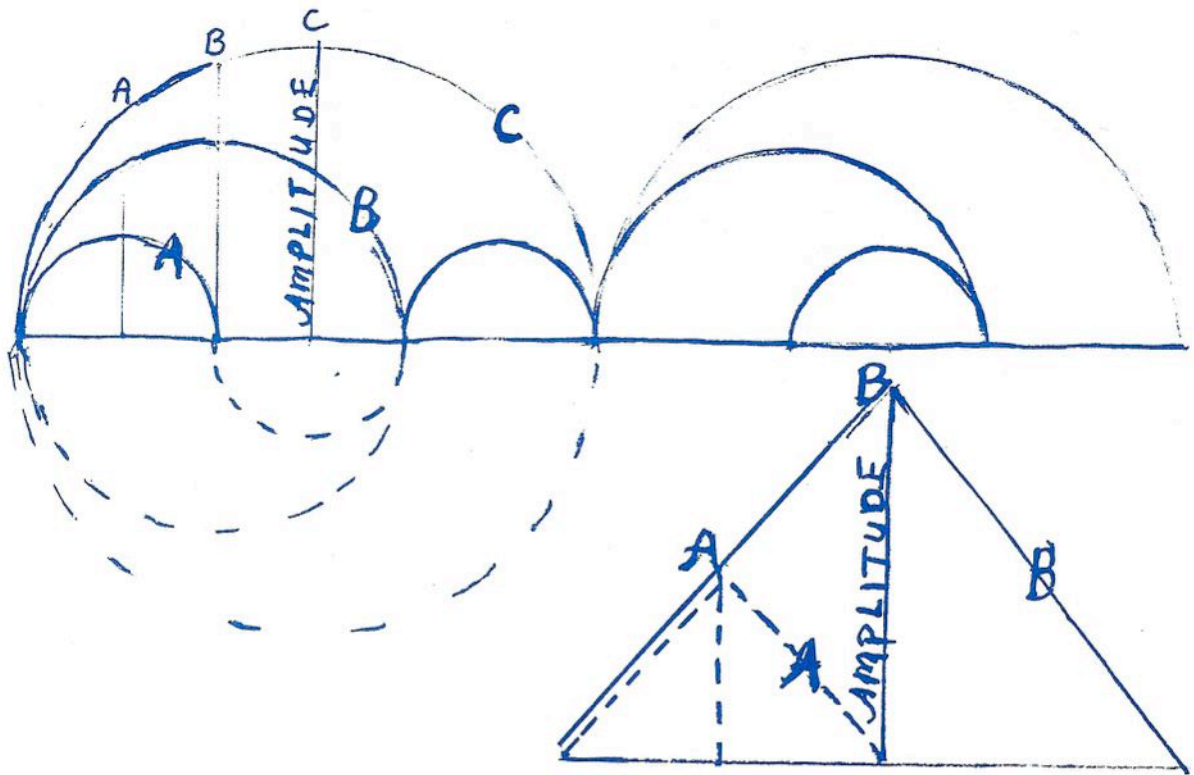

While we could arbitrarily place the scale and the wave to line up in many different places in relation to the pyramid, Davids' placement appears to have some significance that the others lack. This geometry has the wave change of direction placed so that in Russells' Cosmogony the amplitude of the wave and the trough are at the missing half notes in the scale. A wave changes direction at two places which are the amplitude and the trough. In this placement they correspond to the missing half notes and significant internal structures of the Great Pyramid.

Now let's understand the internal structures of the great pyramid as David has shown us in his diagram and his insight about their relation to the geometry we have followed to this point. Note that a part of the kings' chamber of the Great Pyramid is located on the quarter line or middle of one half of one of the sides of the square we in part derived the pyramid from. When we line up the musical scale and sinusoidal wave with this we note that the chamber part, this line, the missing half note and the change in wave direction all occur on this line. What about the chamber part? Why was it placed directly on this line and is it unique? If you look at the blown up view of the Kings' Chamber in Davids' diagram you will see that this part of the chamber indeed is unique.

We will limit our discussion to recognizing that the chamber is partly composed of five horizontally placed granite blocks called "lintels". the lower four of these are all supported/separated by granite blocks and all blocks have an air space separating them. The upper block however is supported/separated by limestone blocks which is what the pyramid is mostly made from. The space separating this top lintel that is different from those below it marks the exact line of the missing half note, and the change of wave direction. In a structure that is about five hundred feet tall weighing millions of tons made out of millions of gigantic limestone blocks the Egyptians marked this exact line and or constructed the pyramid so that the internal structures were aligned in this way.

Now look again at David's diagram and the one following and see the star of David formation and note that the top of the pyramid is the apex of lets say a male vortex interpenetrating a female vortex with her vortex apex very near the pit. There is speculation and some evidence that the pyramid had a cap, now missing, that may have been made of material other than the rest of the structure. All of the alignments suggest to David that if the proper cap is placed on the pyramid and its proper mate has a "cap" near the pit, that then, perhaps, the Pyramid is tuned in and turned on.

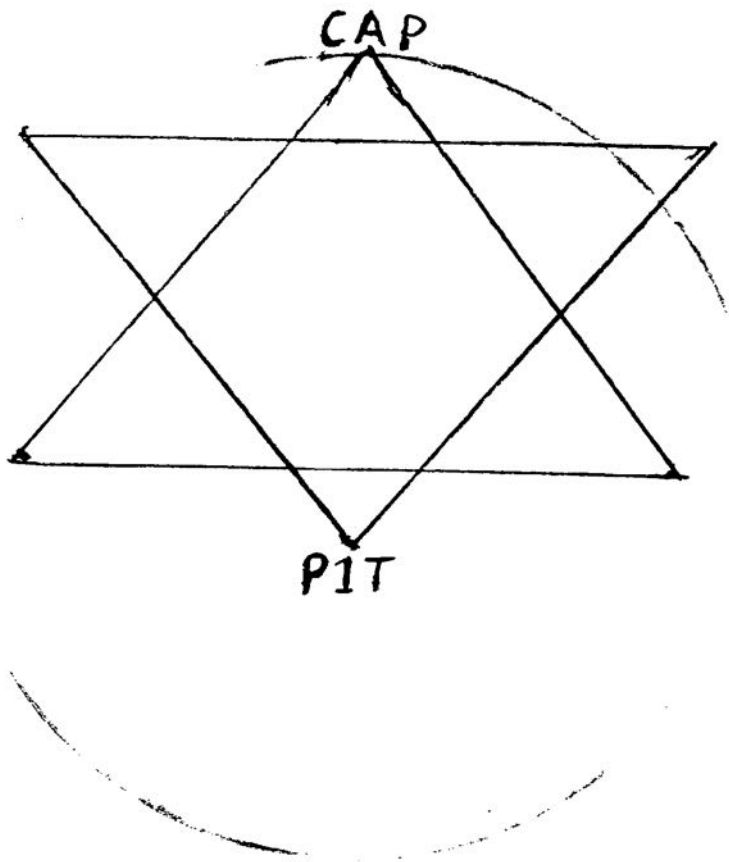

Following are a few questions and speculations about the pyramid:

Questions: Why is this upper block separated/ supported differently? Why is the system of lentils there at all? Does the alignment of the pyramid with the Earth's field affect the pyramids performance? Does the alignment of coils in relation to the Earth field effect coil strength? Can we measure the energy the structure creates with standard equipment such as magnetic and electric field detectors? Why not try using an interferometer to see if the geometry creates a scalar wave field that might not be ordinarily and otherwise detectable?

Speculations: The top lintel was separated by limestone so as to allow a scalar or a life force potential to better develop. I do not know what nurtures a scalar potential or a non organic life force generator, but perhaps limestone at this place in the design of a scalar generator does this. Perhaps it is analogous to the internal structures that allow living bodies to generate life force. The lentil system has the design of a giant capacitor which is an electrical storage device. The granite has quartz crystal that when compressed will generate electric current similar to a quartz crystal watch and radio. Perhaps the granite on granite destroys the capacitor effect or vice versa and ditto for the limestone in these specific positions?

Further speculations: What if we add an extra charge in some way to coils wound as the star or in some form of this pyramid geometry at either or both the amplitude and trough points? Try running two sets of coils both in the same direction and in opposite directions? What types of materials should be used for caps? Perhaps radioactive, gold, silver, rare earths, or mono atomic elements ala David Hudson.

David and I are in process of demonstrating these ideas and Toby Grotz is helping me explore implications from this structure/geometry as it may apply to the coil windings. Our results will be reported on in future editions of Fulcrum.

EXPLANATIONS OF DIMENSIONAL EQUATIONS DETAILING THAT ALL PHENOMENA ARE THE SAME PHENOMENA; OR A UNIFICATION OF HEAT, GRAVITY, ELECTRICITY, AND LIGHT WITH AN ACCOMPANYING GEOMETRY PART ONE - BY TIMOTHY A BINDER.

Mystics throughout time have said that the sensed electric wave Universe is illusion, the ancient vedas called it Maya. Walter Russell said the sensed electric wave Universe had no reality whatsoever. Russell also said that all of this sensed electric wave Universe was simply motion - and yet, even motion was an illusion! He said that the motion we sensed was balanced immediately by a simultaneous opposite motion that in effect resulted in no movement. I will later attempt to interpret this as it appears vague and unclear to me as he stated it. Whether or not I am successful in making it intelligible to myself and to the readers of Fulcrum will be my criteria for success in understanding this idea. This idea appears to me to be another form of the ancient paradox of Zeno.

Russell also said that light was reflected from wave field to wave field and did not move at the same time that he agreed with Einsteins' idea that light moved at constant velocity of $C =$ approximately 186,000 mps. This appears contradictory and unintelligible to me as well and again is another form of Zeno's paradox which is perhaps solved by understanding the solution to the ancient problem of the absolute reality of the One and the Many. Again, I will later offer my ideas about this.

A concrete model that can be used to explain all phenomena is what I am after. My sources of inspiration for this are mostly Scudder Klyce who wrote and published *Universe* in 1921 which book I republished in 1970. It is still available at \$37 postpaid from me. Klyce described the vortex whirl mechanics that follow. Additional sources are obviously Walter Russells' cosmogony with the vortex compression/ expansion etc. model of universal motion/nonmotion.

For me much of physics is abstraction, mathematical abstract theories with little mechanics/geometry to illustrate the concepts. The abstractions are based on assumptions that appear to me to be at best very questionable. I need to question every thing, myself included and everyone till I know what it is we all are conceiving and talking about. In this area the big mysteries and unknowns appear to me to be concerned with finding concrete models for the abstractions that physics talks about. We need models for gravity, for light, heat, electricity/magnetism sound etc.

I do not believe that the model I am advancing is the only model. But, since I understand it to be real and it does explain phenomena to me I figure it will be complimentary and congruent with other models that might also illustrate all phenomena.

Any "thing" must have parts that move relative to each other which in turn are made up of parts ad infinitum. These parts appear to me to be arbitrary as everything is connected to everything just as there is no absolute void space anywhere - there is an ether or the basic substance which is motion, which is objective/subjective, thinking/nonthinking mind - the One /Many. Eventually we reach the limits of our dividing perceptions and/or we speak of and see the parts as one whole unit. A splitting of any thing into parts demands relative motion. Is there anything that does not move relative to something else? I have experienced no such thing, nor can I conceive of any such thing. Therefore I recognize all of Universe to be in motion. Explanations and the mechanics for the concepts of electrons, protons, neutrons, light quanta, ether, etc. all eventually come to a place of stopping splitting these parts into more parts. The idea of an ether is the inevitable realization that eventually we stop splitting and that universal continuity is real. The Tao is a model for this.

The Tao symbol has two parts that are opposite polarities that are related by a difference surface that is the dividing/connecting line between them. Each male and female half has a small dot or portion in it to represent the little bit of opposite polarity that is in it. The small dots of opposite polarity represent recognition of the infinite regress of dividing/connecting parts into more parts and back into wholes. The Whole Tao symbol is recognized as a symbol for wholeness, unity, no void space, and ether,

simultaneous motion/nonmotion. It is a symbol for Universe. The Russells used the lever or see-saw as such a model and it is essentially the same model. The two sides of the see-saw represent the male and female sides of the Tao. The Fulcrum is the Tao's and the see-saw's fulcrum/dividing/connecting line. The see-saw is the One, the Tao. A vortex whirl is also a model or an archetype for Universe. Like the see-saw, a whirl also has the advantage of being a dynamic model. It can be used to describe all or any motion.

Any motion I can conceive of moves in three dimensions and as it moves sequentially it creates the fourth dimension of time. Walter Russell gave eighteen dimensions to Universe. Length, breadth, width, and time are four of these. Eventually in this article and in future editions we will examine all eighteen dimensions in terms of our models.

If we recognize that motion, continuous substance, spirit, energy, atomic structure or call it what you want lies at the bottom of all phenomena, then it follows or is a truism that any thing will be made up of parts ad infinitum and we will at some point in our description of any thing finally quit dividing or multiplying the parts and consider the thing as a whole, a unit, One, or it could be called a point. In this the final case we are considering that point to not have internal structure or parts. Vortex whirl mechanics are a model for the ether or the only thing there is. This model is also a description for the unspoken and undescribed internal structure of a point as well as the basic "substance" or "energy" or "spirit" of Universe; or it expresses the continuity of Universe from compression into form/density and expansion out of form/density.

If two points or parts move relative to each other they may be considered to be sticking together or slipping apart where they join or separate. This movement (integration and disintegration) into and out of form is either 1) rotation in the same direction, pushing apart, and then one point or cell will revolve (mostly) about the center of the other. Or, if they rotate in opposite directions they will come together and then both rotate around some other center (or centers). These again will either rotate in the same or opposite directions

with other points and be forced together or apart from them as well. As this motion does not occur in just two, but three space dimensions, there must be other points that act/react with these two points that are extended up and down from the plane of the paper. These cells will also rotate and ultimately form a closed path so that from our two then to three and more points revolving relative to each other we end up with a doughnut shaped torus structure that is the beginnings of a vortex whirl. See the illustrations that follow.

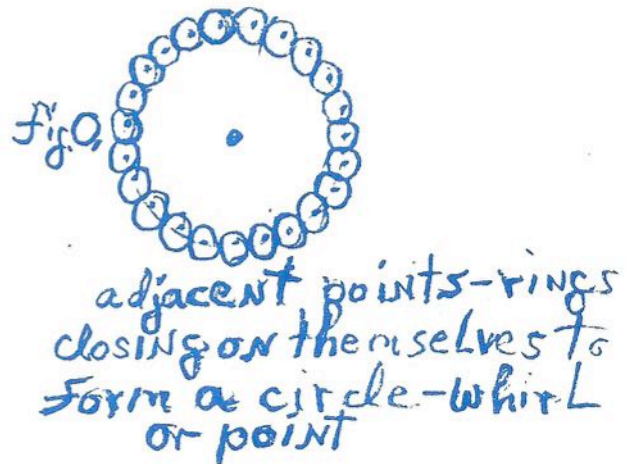
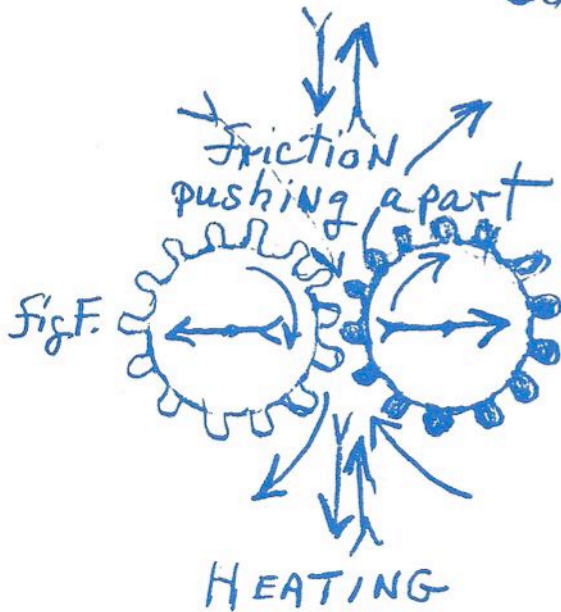
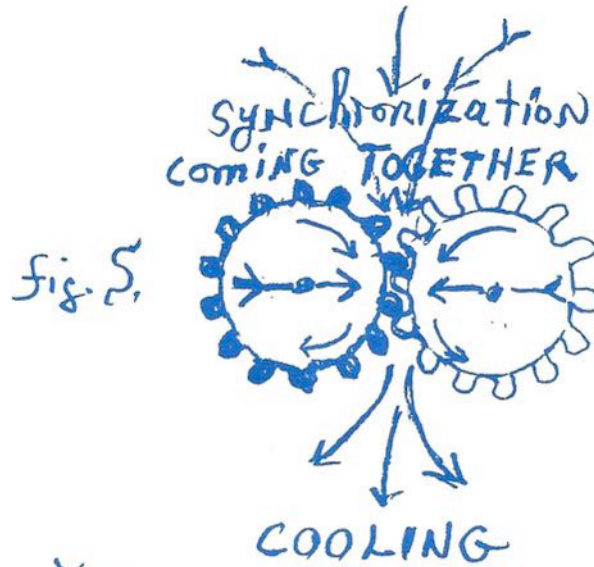

Really Figure I = Figures S, F & O

In the first set of drawings labeled figure S, the direction of motion is coming together or synchronizing; and if we consider these points as gears (now having internal structure) it is clear that the gears will mesh and come together whereas the drawing labeled figure F shows gears that clash and force themselves apart. Both possible gear directions in fact have both directions of motion in them just as there are two opposite polarities of the Tao and two sides to a see-saw or a coin. I am drawing your attention to the infinite regress of opposite conditions that is inevitable and inherent in our model machine and in fact is in any part of Universe. In the gears that mesh they also have their opposite where the teeth hit and here they finally act to push apart and this is registered as

friction and heat. So the meshing has unmeshing and vice-versa. These two sets of gears/points illustrate aspects of centripetal and centrifugal motions that we will also see more of as we develop the vortex whirl model.

So as the points are extended out in a closed path they create the donut shaped torus as illustrated in figures O and 2. The direction of motion appears counterclockwise in the right gear of figure S. But, as the whirl forms and moves through the closed path we now see it still moving in the same direction but from the other side or on the other side of the whirl and here it appears as clockwise motion as in the left gear of figure S or also see the left and right sides of the filament of the whirl in the left side of figure 2.

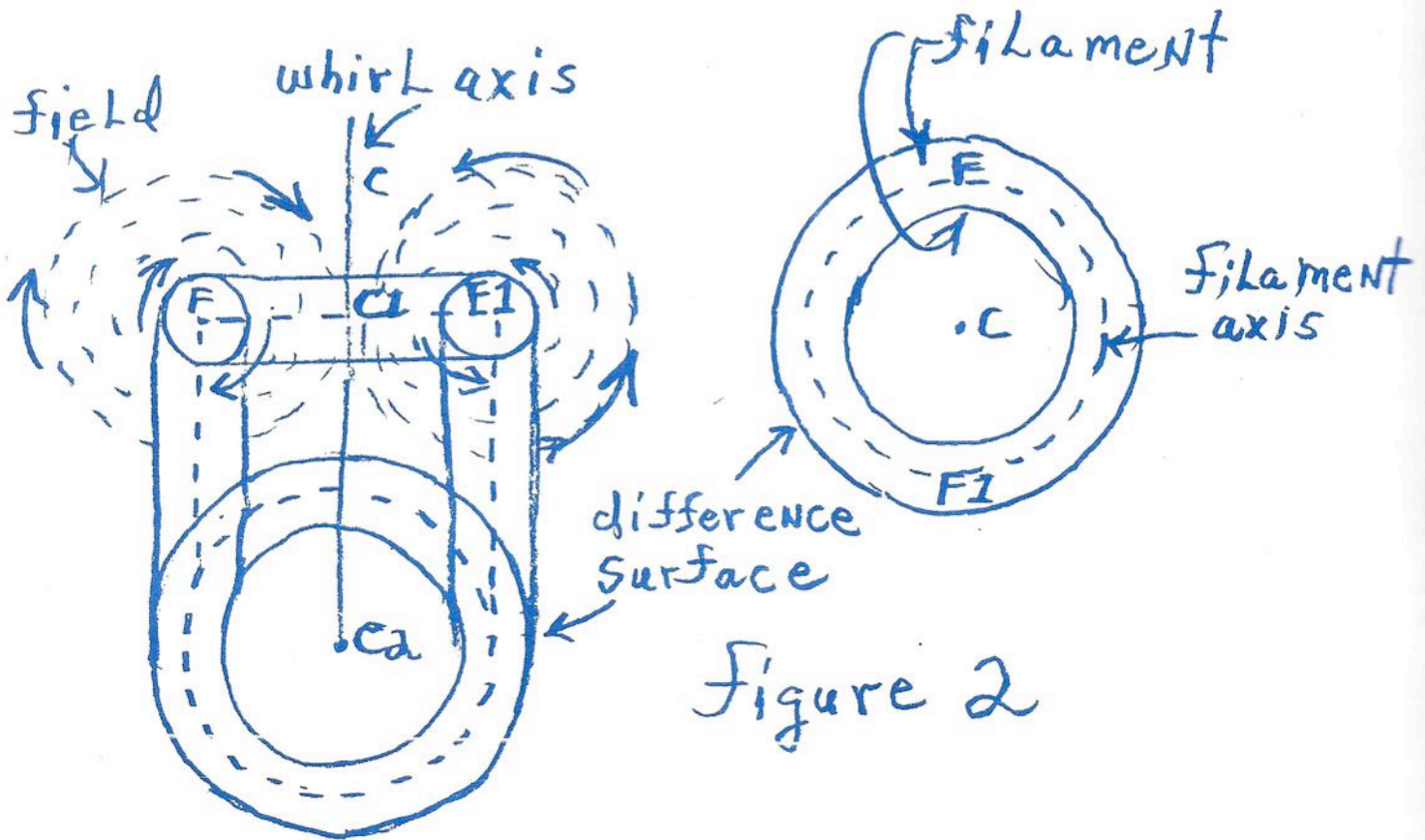

This whirling motion in a closed path that forms our torus we shall call the filament of the whirl. This is outlined in side view in figure 2 by solid lines. The center line of the filament about which the cells rotate is labeled F to F'. This F to F' line is shown in figure 2 as the broken lines inside the solid lines. this line F & F' we will call the filiar axis.

The points or cells that shade off in both directions from the solid lines internal and external to them represent other points or cells that are also rotating but at decreasing speed from those rotating right on the solid line surface. Those rotating off of the solid surface constitute the field of the whirl and those on the surface we shall call the field difference surface cells. The difference surface is represented by the solid lines and the fields by the broken lines extending out both internal and external to the difference surface. The line that is approximately perpendicular to the center of the filament labeled C, C' and C2 we shall call the main axis or the whirl axis. Figure or painting No. 41 from *In The Wave Lies The Secret Of Creation* is a whirl similar to this description. It also is the cover painting for this issue of *Fulcrum*.

So we see the whirl from plan or top to bottom view and in cross section or side view in our illustrations. The top of the left part of figure 2 is the cross section and the bottom of this side and the right part of figure 2 is the plan view.

The whole whirl or any parts of it can be seen or considered as see-saws, as the Tao - yin - yang symbol or as other smaller whirls. Movement towards the inside of the whirl (later to be described as at 90 degrees to the difference surface causing the whirl to grow) can represent the yang, "downward" moving, compressing into spherical form center of gravity, mass and masculine side of the see saw. This creates and is movement along the whirl main axis. Movement to the outside (later to be described as tangential or at 0 degrees to the difference surface causing the whirl to dissipate and die) represents and is the female, yin, "upward" expanding out of form to cube wave field boundary side of it. This creates and is the whirl filament. See figure 3. In this case the filament difference surface is the fulcrum of the see saw. Or, the whirl axis can be considered as a dividing/connecting fulcrum and the the main fields the yin - yang extensions of the see saw.

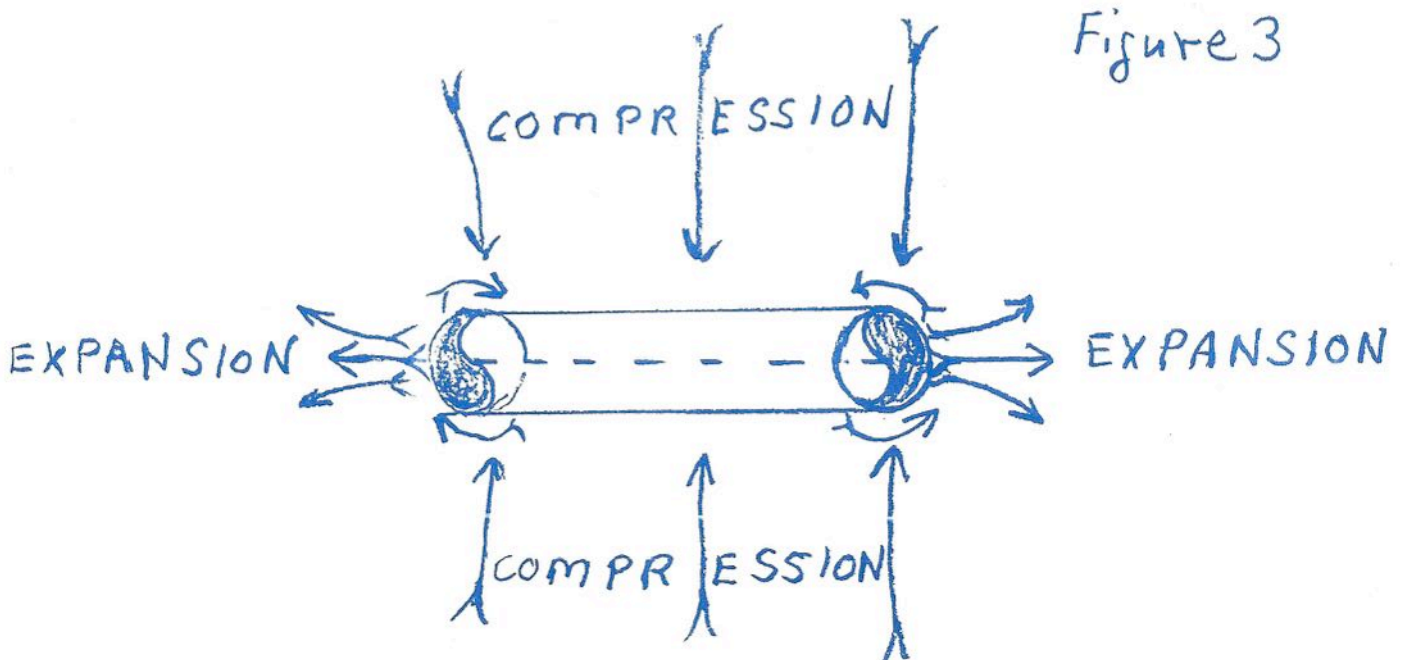

Consider the motion in the filament. As this motion cannot be absolutely uniform or symmetrical, it must eventually sum into some imbalance where the cells moving faster at some part of the difference surface will cause a bulge to form as shown in figure 4. Eventually these cells, whirls or points of motion will break free from the difference surface forming a new

baby whirl that will spin off and then up or down from the parent whirl. (It moved down in the discharging oblation part of figure 4.) Or, collections of whirls will all seek a path of least resistance (a centripetal closing spiral) that causes them to coalesce or come together to form a new bigger whirl. These both demonstrate discharging oblation and charging prolation respectively.

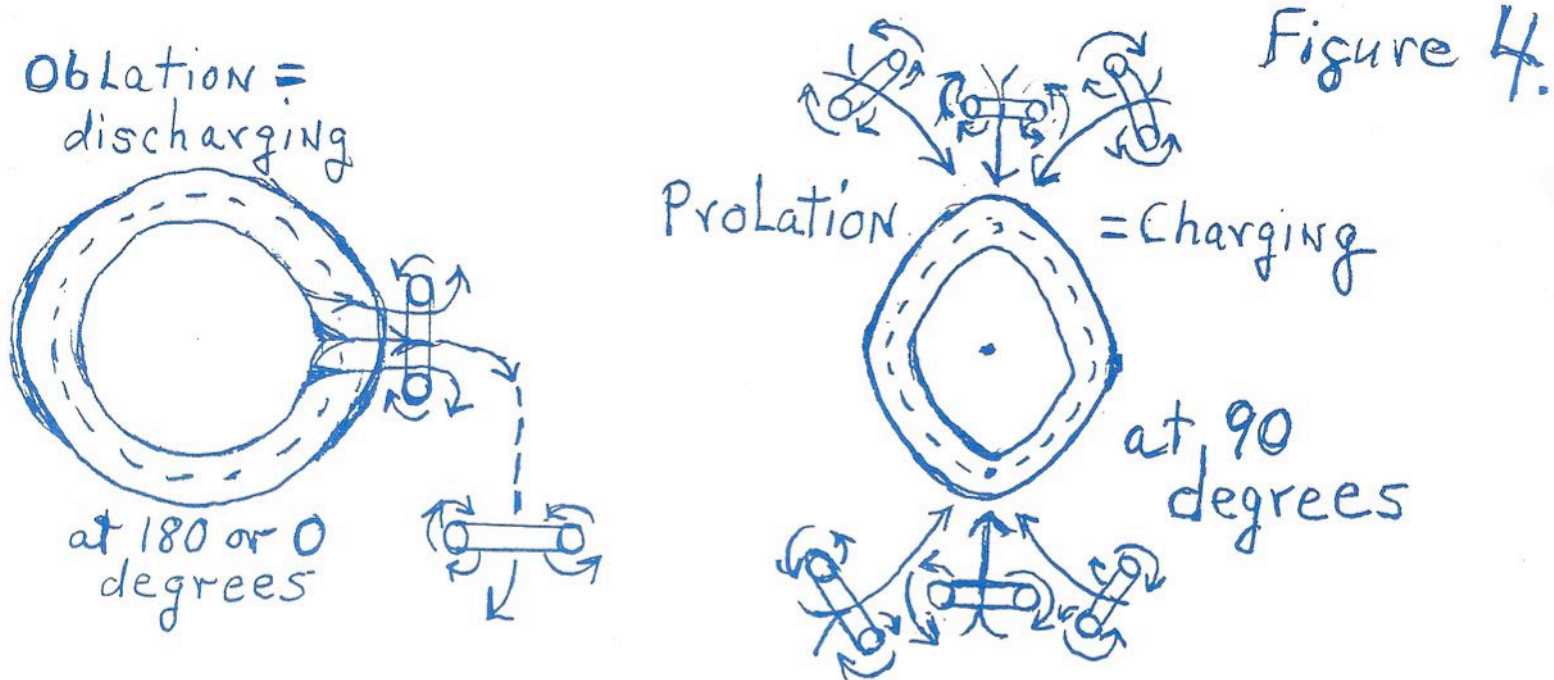

The actions illustrated in figure 4 are examples of centripetally and centrifugally directed motions or gravity and radiation or the whole cycle of Gravity. So here we have a model for gravitation/radiation mechanics or a geometry of Gravity. Lets look at it from another point of view too. My contention is that we can see this model in every part of the model as long as we continue to make parts of it- bigger or littler parts or whirls, either way. Or, in other words to see action and reaction as either inner or outer viewpoints. If we look at the difference surface of the filament which is where the fastest motion of the whole whirl occurs, then because that motion is not absolutely balanced it will always form a combination

of spiral and helical motion around the filiar axis as illustrated in figure 5. The motion will either approach 90 degrees to the filiar axis or 0 degrees to it. If the motion approaches 90 degrees then cells (smaller whirls) at that point will be drawn into the filament and it will grow. If the motion approaches 0 degrees the cells at that point will be thrown out of the filament and it will decrease. In this way our whirl exhibits characteristics that are associated with growing and dying, eating nutrients and disposing of wastes, or say with impregnation, gestation and giving birth. In essence we begin to see how this model does apply to all things.

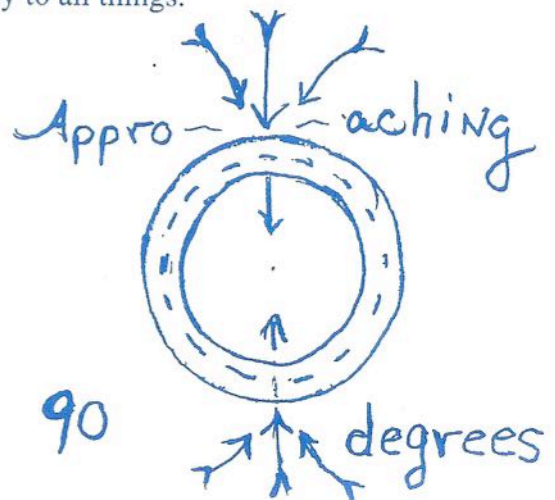
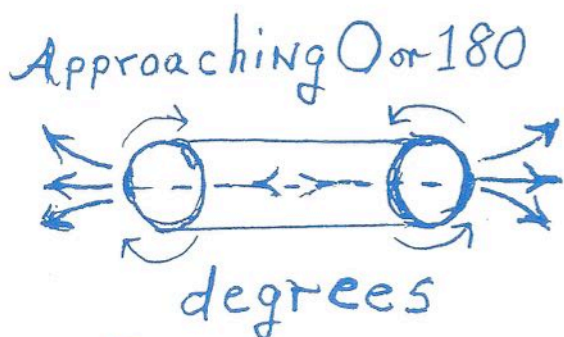

Figure 5

The motion approaching 90 degrees is centripetal, a drawing in gravitational motion; that approaching 0 degrees is a centrifugal expelling or radiation motion. Any whirl will have both aspects happening at the same time with one in greater degree than the other.

So let's look again at our figures and relate them to our familiar Russell diagrams and concepts. As motion comes in from all around the whirl filament that is preponderantly coming in at and approaching 90 degrees, the whirl spins tighter and faster creating more electrical induction, density, more incandescence and heat. As motion in the filament slows and approaches 0 degrees the whirl spins looser, ever more slowly, all manifesting more magnetic conduction, more tenuosity, darkness and cold.

This illustrates the geometry for Gravity or gravitation/radiation. The dimensional equation is $G = g/r$ or Gravity equals gravitation and radiation; or $G =$ centripetal motion approaching 90 degrees times centrifugal motion approaching 0 (or 180) degrees. Also, gravity = centripetal motion approaching 90 degrees - all that coming from boundary wall planes that is ever tending towards 90 degrees. Radiation is the opposite of the preceding. Gravity is most intense at the center of a wave field or at the filament where the whirl is very tight and steady. Radiation is also the most intense at this same wave field center, the filament of the whirl position. But, these are most intensely expressed in planes approaching a perpendicular to the plane of their opposite mate.

Russell illustrated gravitation by the geometry of the sphere as an archetypal (and abstract) form and the cube as an archetype for radiation. He pointed out that all motion, all effects, have both aspects of motion in them just as a whirl has a predominately polar centripetally directed axis of motion as well as a predominately equatorial centrifugally directed axis of motion.

I suspect that when we experience a whirl at its poles we experience more gravity and from its equator more levity or "antigravity".

In the next issue we will look at how our whirl exhibits electricity/magnetism, temperature, light and sound. As a prelude to that I will say that we experience these phenomena as different as they are vortex whirl motions at different periodic/harmonic levels. By this I mean at least partly that Gravity is the movement of everything and anything, the movement of the ether - movement from microcosmic to macrocosmic scales and vice versa. It is the universal motion into and out of form. The movement in vortex whirl formation of parts of electrons we experience as light, collections of these whirls as electricity/magnetism, the eddy currents or less systematized whirl movements of these atoms and their parts we experience as temperature and so on. How and at what level we interface with this vortex whirl formation determines what we mostly register and experience. I think that to be able to visualize this is the key to engineering it.

Let's revisit another Gravity model that I gave from Klyces' book *Universe* in a past issue of *Fulcrum*. This model is Bernoulli's Theorem. See figure 6 following for the visuals. Imagine a pipe with fluid flowing in it. The pipe has a constriction in it in the form of two bulges and one bigger than the other, although the size difference is not essential for observing the principle of Gravity. The big bulge can represent the sun and the small one the earth.

In an actual pipe if you put pressure meters in the form of a small pipe coming off the pipe in the wide and in the constricted areas you will find that the constricted area has less pressure and therefore less fluid flowing up the metering pipe. I believe this type of fluid flow valve measurement is called a venturi meter. In the constricted area you will find the fluid

pressure is less and the fluid flows through the pipe with a greater velocity. This is similar to squeezing the end of a hose or constricting the outflow at the end with a thumb to shoot the water out farther. It is also a demonstration of the principle that mass varies with velocity. The stream of flow through the area is smaller and of higher speed and vice-versa.

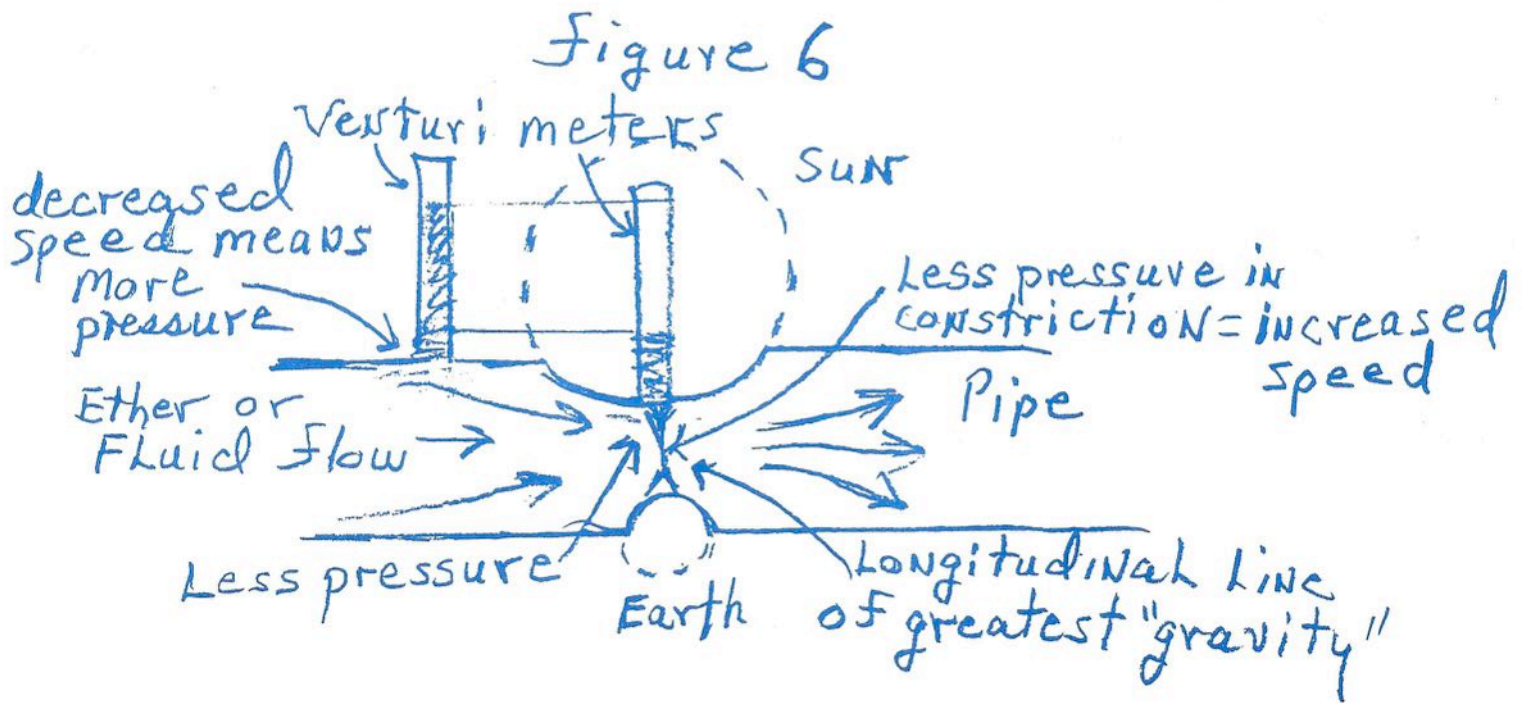

This fluid flow model can be an example of gravity between the sun and earth. The large bulge is the sun, the small bulge the earth. The ether fluid flow between earth and sun is constricted most there and therefore has to move at higher velocity and with less pressure just as in the pipe with constriction. The ether flow all around these two bodies is slower and greater pressure than on the longitudinal line of constriction between them. This diminished pressure is simply another point of view giving an alternate mechanics and a geometry to illustrate what Walter Russell said about gravity being a pressure from the outside to compress mass into form. The diminished pressure acts to draw or push (depending on viewpoint) the sun and earth together just as it does the sides of the constricted pipe. The pipe sides have less pressure pushing out at the constriction or more pushing in from the outside. This is the same thing as the Casimir effect with say two metal plates being pressed extremely close together and sticking because the ether flow outside the plates pushes more than it pushes between them. This is a form of the model that is visualized by "zero point" energy researchers in their quest to tap the vacuum for energy. I hope that the geometry illustrated in this and that to come in part two of this article will help all of us to learn how to control the entire cycle for energy production and new transportation modes.

Lets consider this model in relation to our vortex whirl model for all phenomena. The center of the constricted part of the pipe corresponds to the difference surface of the whirl. The highest spin velocity of ether cells (or light, EM, and temperature whirls) occurs at the difference surface and that would correspond to the

constricted pipe center. The boundary walls of the pipe guide the vortex fluid flow motion in a whirling closing centripetal spiral just as boundary walls in the form of other ether streams guide the whirls vortex flow. In Russells' Cosmogony the closing centripetal vortex flow is guided by the centrifugal opening vortex flows' opposition; or the cubes boundary walls direct the spheres formation and the spheres' disintegration creates the cube boundary walls by resistance to radial motion from other cube boundary walls (other vortex whirls).

Gravity is vortex whirls growing through ether cells entering the whirl at the filaments difference surface at 90 degrees (this part up to here alone is gravity, with the rest of the process it is Gravity) and radiation is ether cells leaving the whirl at the difference surface at 0 degrees. Whirls grow through gravity with the already described geometry/mechanics and decrease or die over time through radiation with this geometry/mechanics.

Whirls are most cube like at cube wall boundary and sphere like at cube centers. no actual parts of the "many" or parts of Universe are perfect cubes or spheres. Perfect cube/spheres are abstract limits of form just as zero and infinity are abstract limits of measurement/numbering.

In part two of this article we will look at how light, electromagnetism, and temperature are vortex whirls identical with gravity vortex whirls and why we sense them as different phenomena along with the dimensional equations for all of them.

The Ohsawa-Kushi Transmutations

Robert Nelson
Rex Research

Nuclear physicists bombard targets with high-energy particles in order (or chaos) to prove the schematic of their mindset with appropriate experimental results. In recent years, however, the discovery of cold fusion has quite upset the world view of conventional physicists, who generally deny the possibility that Nature allows for other means of transmutation. Yet, there is considerable historical evidence that many types of transmutations have been accomplished without particle accelerators, long before Pons and Fleischman announced their discovery of cold fusion. There is so much credible documentation of low-energy alchemical transmutation that, in the words of Rupert Gould, "did it relate to any more probable event, we should be compelled either to accept it or cease putting any faith in recorded testimony."

Among the many examples that can be cited, "biological transmutation" is the best developed and well-known. About forty years ago, Dr. Louis Kervran presented the idea that sodium, potassium, and dozens of other elements change into each other under certain natural conditions in the mineral, vegetable, and animal kingdoms. Biological transmutations have been demonstrated, crucial experiments replicated, and the theoretical principles verified by many scientists who are finding new industrial, medical and agricultural applications of the discoveries.

Inspired by the pioneering work of Dr. Kervran, Dr. George Ohsawa sought to transmute sodium into potassium *in vitro*. The method revealed itself to him in a symbolic dream. Thus inspired, Dr. Ohsawa and Michio Kushi, *et al.*, constructed an experimental electric discharge tube with copper (Yin) and iron (Yang) electrodes and a valve through which to draw a vacuum or admit oxygen (Fig. 1). The first transmutation with this equipment was achieved on June 21, 1964. After applying 60 watts of electricity for 30 minutes to heat sodium to a plasma, a molar equivalent of oxygen was introduced. Viewed with a spectroscope, the orange band of sodium gave way to the blue of potassium, according to the formula:



Analysis of the reaction product confirmed the result and revealed an unexpected extra: a trace of gold was produced by the combination of Na, O, and K with the Cu and Fe electrodes. Several different metals were tested as electrode materials. Neon and argon atmospheres were found to enhance the yield of potassium and other elements. External heating of the reaction tube also served to ionize the sodium.

Kushi and Ohsawa, *et al.*, proceeded to develop the process for industrial-scale production. They estimated that potassium could be manufactured for 1% of the current price. In a correspondence to Ken Jones (12 October 1980), Michio Kushi stated that, "After George Ohsawa and myself succeeded in producing K out of Na and O... we

presented the experiment to several chemical corporations. At that time, Pfizer International became most actively interested. We had conferences on several occasions; however, soon after we decided not to become involved with these corporations, as a result of the considerations of the vast effects this would have on the industry." The researchers also had no patent with which to protect their interests.

Ohsawa and Kushi then turned their attention to the manufacture of steel by transmutation of carbon and oxygen according to the formula:

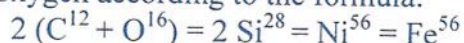

The experimental arrangements worked as predicted, and produced several other elements from combinations of C and O with atmospheric nitrogen, etc.. Strangely, "the Fe produced by this transmutation is stainless; it does not rust easily. Also it reacts much less to heat than does ordinary Fe... All results of the transmutation for Fe have been carefully examined and analyzed by several methods, as: (1) magnetic inspection, (2) spectroscopic analysis, (3) chemical analysis, (4) examination by reagents, etc., and confirmed by authoritative testing agencies."

"Method 1: Transmutation in Air [Fig. 2] --- Two graphite crucibles (approx. 2.5" x 5") cover each other top and bottom. The upper crucible has a 10 mm. Hole, surrounded by a ceramic ring, which acts as an insulator. Into this hole a carbon rod (0.25" diam.) is inserted until it reaches the 2 or 3 grams of carbon powder placed at the bottom of the lower crucible, which has one or two small holes at the lower part of its side wall for circulation of air. An iron base placed under the lower crucible acts as another electric pole. As the carbon rod approaches the powder, the electric arc arises. Continuing the operation for 20 to 30 minutes, the carbon powder changes to iron. In this experiment, the applied electricity is about 35 to 50 volts, and 8 to 18 amps, either AC or DC.

"Method 2: Transmutation in Water --- Using two carbon rods (0.25" diam.), create an electric arc between them, striking them on one another in water. This operation is performed for 1 to 5 seconds. Then, brown-black metallic powder (which contains iron) falls down to the bottom of the water.

"Method 3: Transmutation in Air --- Carbon powder is placed on a copper plate, approximately 12" long, 6" wide, and 0.5" thick. This plate works as an electrical ground. A carbon rod (0.25" diam.) used as the other electrical pole, is struck repeatedly to the carbon powder on the plate, producing an electric arc. The carbon powder changes into iron.

"During the process of this transmutation, nickel is temporarily produced as a short-lived radioactive isotope. The degree of transmutation from C and O is approximately 5% to 20% immediately, with a larger percent of transmutation occurring gradually in the air, which has the effect of cooling the metallic powder to below room temperature."

In another experimental configuration (Fig. 3), the reaction was cooled by dry ice. When sparked with carbon rods, the CO₂ vapors also yielded iron, etc..

In 1994, R. Sundaresan and J. Bockris (Texas A & M) reported that they had observed "Anomalous Reactions During Arcing Between Carbon Rods In Water:

"Spectroscopically pure carbon rods were subjected to a carbon arc in highly purified water. The arc current varied from 20 to 25 A and was passed intermittently for several hours. The original carbon contained ~ 2 ppm Fe. The C rods remained cool to the

touch at >2 cm from their tips. Adsorption of iron from water or the surrounding atmosphere was established as not being the cause of the increase of iron. There is a weak correlation between the iron formed and the time of passage of current.

"When dissolved O₂ was replaced by N₂ in the solution, no iron was formed. Hence, the mechanism

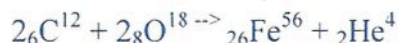

was suggested as the origin of the iron. The increase in temperature of the solution was consistent with expectation based on this reaction."

Also in 1994, another group of researchers (M. Singh, *et al.*) at the Bhabha Atomic Research Centre (Bombay) reported "Verification of the G. Ohsawa Experiment for Anomalous Production of Iron from Carbon Arc in Water:

"A direct current arc was run between ultrapure graphite electrodes dipped in ultrapure water for 1-20 hours. The graphite residue collected at the bottom of the water trough was analyzed for Fe content by a conventional spectrographic method... The Fe content was fairly high, depending on the duration of the arcing... The results showed large variations in Fe content (50 to 2000 ppm) in the C residue. In the second series of experiments... with the water trough fully covered, the amount of Fe in the carbon residue decreased significantly (20-100 ppm). Here also there were large variations in the iron concentration in the residue, although the experiments were performed under identical conditions. Whether Fe is really being synthesized through transmutation from C and O as suggested by George Ohsawa or is getting concentrated to different degrees through some other phenomenon is not currently clear. The Fe in the C residue was also analyzed by mass spectroscopy for the abundance of various isotopes... Besides Fe, the presence of other elements like Si, Ni, Al, and Cr was also determined in the C residue, and it was found that the variation of their concentrations followed the same pattern as that of Fe."

In 1996, Kenjin Sasaki reported his successful experimental replication of the carbon arc production of iron. He used a 99.9999% pure graphite crucible and rod with a 100V/10A electric welder. The crucible was cooled. The arc (8-10A) struck high-purity carbon powder 4 times for 1 minute each time. The yield of iron was recovered with a magnet.

In his book *Transmutations A Faible Energie*, Louis Kervran mentions that "Professor [Masashiro] Torii, on a circuit designed by Prof. Sakurazawa, and under the control of Prof. Odagiri, observed in the spectroscope the passage of sodium to potassium upon the adjunction of a small quantity of oxygen to sodium vapor...

"Prof. Torii [of Musashino Institute of Technology, Tokyo] has informed me of having observed on 21 June 1963, in the spectroscope, the passage of sodium to potassium, the disappearance of the yellow line of sodium being replaced by the red-violet ray of 7699 Å potassium; the experiment was repeated June 22 before five scientists."

Dr. Kervran also cited the example of, "in the production of steel in electric furnaces, the incomprehensible appearance of boron. We see now that we cannot exclude, under the effect of a powerful electric field and of the high temperature of these furnaces, the 'reproduction' of carbon from the loss of hydrogen and in keeping with: C - H = B."

Dr. Kervran recommended the following experiment: "The experience is simple to realize, as it suffices to take a plate of steel --- or of iron --- an anode of magnesium, place

them in a jar containing distilled water rendered conductive by a salt of magnesium --- in order not to introduce any metallic ion other than magnesium, and these two electrodes are reunited by a metal wire, to the exterior of the jar; thus they realize (in part) a battery with magnesium at the negative, iron as positive; through the production of hydrogen at the electrode, magnesium is at a potential of 1.9 volts more negative than iron. Leave it for two or three months; from time to time add a little distilled water in order to compensate for evaporation. On analysis, calcium is obtained... in an operation in which calcium was not introduced!"

The calcium (as oxide) accumulates in scales on the cathode.

In the 1980s, Michio Kushi resumed his experiments with the "aim of finding methods of mass production... At that time I shall be able to consider how to present to the world the transmutation of the atom using the principles of Yin and yang for the future world industry.

"The transmutation of the atom can be achieved if elements are changed into the state of plasma, and if these elements are well understood in their antagonistic and complementary relations to other elements, according to the principles of Yin and Yang.

"The atomic number, mass, density, and gravity, physical reaction to temperature such as melting and boiling points, chemical reactions to other elements, reactions to specific environmental factors, such as ultraviolet and infrared wavelengths applied to the elements, as well as spectroscopic color analysis --- all of these characteristics of the atom can contribute to classify the atom into the Yin group or Yang group...

"Nothing is solely Yin or Yang: everything involves polarity. There is nothing neuter. Either Yin or Yang is in excess in every occurrence. Large Yin attracts small Yin; larger Yang attracts small Yang. At extremes, Yin produces Yang, and Yang produces Yin. All physical forms and objects are Yang at the center and Yin at the surface."

In accordance with this Taoist atomic theory, "Hydrogen, the center of the atomic spiral, is Yang. It gathers particles to itself, forming the first octave of creation. The conditions become apparent upon studying the melting and boiling points of the first eight elements.

"Within the first octave, the greatest attraction is between carbon and oxygen, which represent Yin and yang respectively. It is the fugate interaction of these two that form the other elements. Carbon is often replaced by boron. In terms of Yin and yang, these are like brothers in that they react in similar ways in forming new elements."

Since the initial experiments were conducted by George Ohsawa and Michio Kushi in the 1970s, several other researchers have reported the same results and more, thanks to modern analytical equipment, computers, and communication. The worlds of low-energy transmutations have become much more accessible to us. New discoveries (cold fusion and biological transmutations especially) are being reported at an increasing rate in the scientific literature. Some inventors already claim to be producing rare elements in bulk. Perhaps within a few decades we shall see the mass production of elements on demand...

<u>Classification</u>	<u>Yin</u>	<u>Yang</u>
Tendency	Expansion	Contraction
Position	Outward	Inward
Structure	Space	Time
Color	Purple	Red
Temperature	Cold	Hot
Weight	Light	Heavy
Catalyst	Water	Fire
Atomic	Electron	Proton
Elements	K, O, P, Ca, N	H, As, Cl, Na, C

The Fugate of Carbon

1 (C + O) = Si	5 (C + O) = Ce
2 (C + O) = Fe	6 (C + O) = Er
3 (C + O) = Kr	7 (C + O) = Pt
4 (C + O) = Cd	After Pt the elements become increasingly Yin

References

1. Anonymous: *The Order of the Universe* 3(10): 12, 14-17
2. Gardiner, Bruce: *East-West Journal* (February 1975), p. 15
3. Harris, P.M.: Unpublished lab notes (March 1965)
4. Kervran, Louis: *Transmutations A Faible Energie*; 1964, Libr. Maloigne, Paris; *ibid.*, *Preuves Relatives A l'Existence de Transmutations Biologiques* (1968); *ibid.*, *Transmutations Biologiques en Agronomie* (1970); *ibid.*, *Biological Transmutations*; 1972, Swan House, NY, &c...
5. Kushi, Michio: *East-West Journal* (February 1975), pp. 22-26
6. Kushi, Michio: *Kushi Institute Study Guide # 10: "Atomic Transmutation"*
7. Mallove, E.: *Infinite Energy*, March-April 1996 (#7)
8. *Fusion Technology* 26: 261, 266 (1994)
9. Ohmori, T. & Enyo, M.: *J. New Energy* 1(1):15-22 (1996)
10. Patterson, James A.: *U.S. Patent # 5,494,559* (27 Feb. 1996), "System for Electrolysis"

FIGURE 1
 $\text{Na} + \text{O} \rightarrow \text{K}$

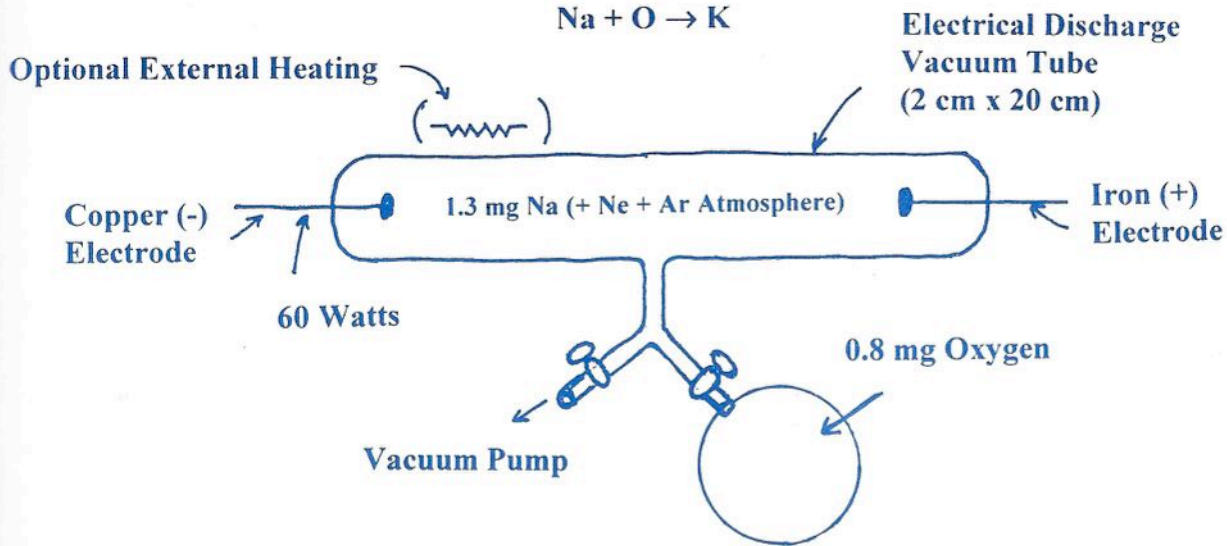

FIGURE 2
 $2 (\text{C} + \text{O}) \rightarrow \text{Fe}$

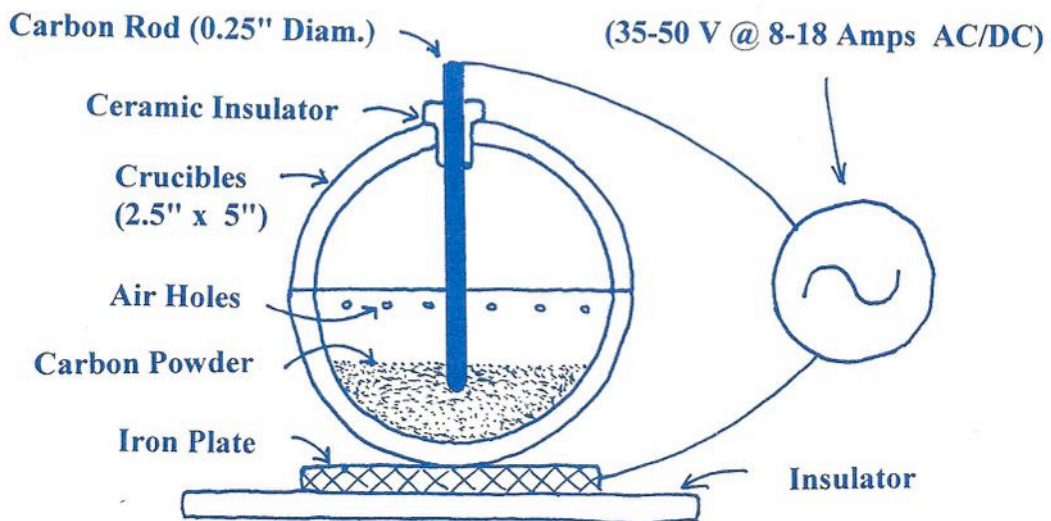
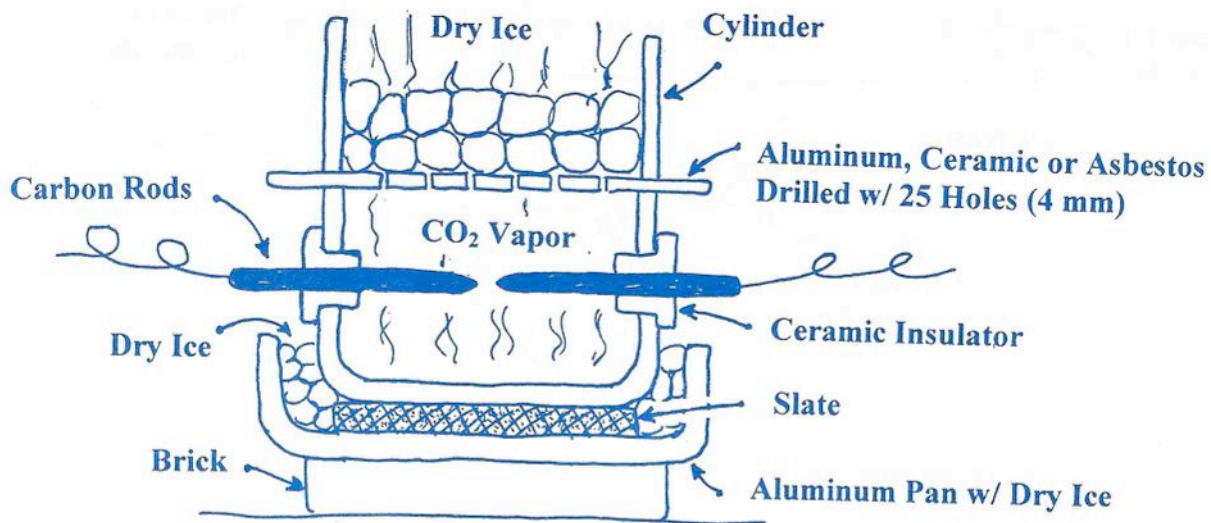

FIGURE 3
 $2 (C + O) \rightarrow Fe$



Reaction Time: 15-30 Minutes
(15-30 Volts DC @ 17-20 Amps)

From the Archives

January 7, 1956

Dr. Claude Gilmore Walker,
NATIONAL CAPITAL ASTRONOMERS,
1340 Girard Street, N. W.
Washington 9, D. C.

Dear Dr. Walker:

Your profound address - inspired by my book "GOD WILL WORK WITH YOU BUT NOT FOR YOU" - given before the National Capital Astronomers recently, addressing me as the progenitor of a Cosmic philosophy, has left a deep impression upon both my husband and me after hearing it, that there is no alternative left to me other than to reply to it with the gravity that it deserves, and the sincerity which impelled me to give my thoughts to this needy world to stimulate the unfolding of Spiritual Man from his physical chrysalis.

My reply is all the more imperative because of the spiritual nature of the experience related by you during one night, which fully indicates to both of us that you have been allowed to touch the hem of the Cosmic Garment by having a goodly flash of that divine Light of Cosmic Consciousness, which precedes the still higher spiritual unfolding of man in that rare experience of complete severance of Consciousness from sensation, such as my husband and I have both experienced, and from whence our knowledge has come.

The imperative nature of my reply is reinforced by my duty to reply. It becomes a responsibility to the human race and an obligation to you which I cannot evade, for it is our grave responsibility, as Illuminates, to discover the awakening Light when it appears in others and give it its sorely needed guidance lest its powers be rendered impotent by the senses from which it has been temporarily freed. The greatest danger which can happen to one whom the promise of Illumination has been given by such a forewarning as you have experienced, is where the glorified one unknowingly allows the reasoning of his senses to help uplift him to higher pinnacles and mistaking that dread fact for growing awareness of Consciousness.

And that is what is so obviously happening to you, as it has happened to greater Illuminates all down the ages, from Buddha to Mohammed, and from Pythagorus to Mary Baker Eddy. That outer reasoning of the Buddha gave the world a different conception of God and His purpose than the outer reasoning of Mohammed gave to it, and when Mary Baker Eddy reasoned with her senses, after her return from the Infinite into the world of matter, she confused the two as her predecessor mystics likewise did, but even then, these three great mystics overturned the thinking of their day and made another world. Jesus was the only mystic of all time who never allowed his outer vision to dim the Light of His inner knowing for He lived the life of the mystic for a whole generation of time before he spoke one word of His divine teachings to man. When His preparation was complete, and His Day had come, He then began to deliver the Message given to Him by the Father-Mother which began in His early childhood and continued persistently, unknown to all the world.

Even at the end of His lifetime of preparation He had His greatest reverence of sensation from Consciousness by His forty days and nights in the wilderness. Had Jesus begun to give His Message at an earlier date His crucifixion would have begun then, as yours has already begun by people thinking you a "little queer".

To make it more clear to you what you have done, let me explain it to you a little further. While you were having your Cosmic experience your inner sensing was dominant. When you came "out of it," your outer sensing was dominant. Instead of functioning spiritually toward the universal Mind, you functioned physically in the direction of the senses of the body. During your life your body senses have observed many things, read many books and been taught many things by teachers which have all been recorded on your brain. Your outer senses have observed the countless effects of motion, which constitute this universe of illusion. You have accepted this illusory universe of motion as real and have formed countless conclusions which you deem to be factual. This is your stock in trade which forms the basis of your outer-reasoning.

When you superimpose these conclusions of your outer-sense-reasoning from observed simulations of facts upon the truthful facts which come to you from your innersensory perception you become more and more hopelessly confused. The proper procedure for the mystic initiate is silence - and deep meditation to encourage a return of Cosmic inner thinking.

To those whom we are guiding to the path of innersensory perception, our teachings tell them that "the way to multiply their power by increasing their innersensory perception, is to learn how to dissolve that which they SENSE into that which they KNOW. You are doing just the opposite. You are superimposing that which you reason from sense-observation upon THAT WHICH YOU KNOW FROM INNER PERCEPTION."

Our experience tells us that a great number of people have that first flash of the inner Light, and, instead of "sitting under their banyan tree" for long periods of silence and meditation, as Buddha did, they are so overwhelmed by their rare experience that they reason themselves into Messiah Complex cases, or believe that "ascended masters" are sneaking through them. We have had numerous Johns, Pauls, Marys - and even reincarnated Jesus's, all of whom must have had a brief vision of that inner kingdom of heaven in the Light of all-knowing Mind.

Had you followed up your glorious experience with the silence of the true mystic you would have been given more and more knowledge through innersensory perception. Instead of that your superimposed outersensory perception has led you to state utter impossibilities as facts of Nature. We do not fulfill our obligation to you if we do not point out some of these, and we do so with the feeling that your desire for greater mental exaltation places you above the possibility of misinterpreting constructive teaching for personal criticism. For that reason we will point out the most flagrant.

The most impossible of these is your reasoned assumption that there are UNITS OF CONSCIOUSNESS. Thousands of years ago the first known great mystic KNEW - and told to the world - the fact that Consciousness is indivisible. "There is the divided and the undivided" Krishna said, meaning Mind, Soul, Consciousness and the Light which God is. These qualities are ONE - and indivisible. They constitute the universal equilibrium, the stillness from which divided sounds emerge - the silence of that stillness - the omnipresence, omniscience and omnipotence of that silent stillness of the Light of KNOWING MIND.

These qualities belong alone to The Creator and His invisible, undivided Light which is His - and your Mind. MIND-THINKING alone is divided. This electric universe is the divided record of Mind-thinking. This universe of opposed motion is divided into electrically conditioned units, which we call atoms. That is what some inspired scientist meant when he said: "all motion and all matter emerges from space (meaning non-motion) and is eventually swallowed up by space." That is also what the metaphysicians mean when they say "Be still and KNOW." That is what we mean when we tell our pupils to decentralize in order to multiply their powers of inner vision, and to concentrate to multiply their powers of outer-sensing for creative purposes.

Note. The word "decentralize" was coined by us. It is not in the dictionary. As the principle it represents has never been comprehended, no word has ever been coined for it.

You would not think of saying that there are units of silence but you can correctly state that there are units of sound which emerge from silence and return to it for repetition, such as the repetitive vibrations of a harp string which gives out its seemingly continuous sound in sequentially repeated units.

Your outer reasoning habit has not yet made clear to you that there are two directions to sensing which thinking Mind makes use of, outer-sensing and inner-sensing. Outer sensing multiplies motion and the electric potential of thinking in order to concentrate. Outer sensing emerges from the stillness of intuition to become objective - while inner-sensing dissolves the objectivity of motion and sound into the stillness and silence of intuition. It is a "round trip" from zero outward, through compressed multiplicity to an amplitude maximum - then inward by expansive division, back to the zero from which intuition furnished the springboard.

One of the greatest steps forward in mental education is the movement instituted by Dr. J. B. Rhine, of Duke University, for the development of what he mistakenly calls "extrasensory perception." This name for it is inappropriate because he is not trying to increase the physical range of perception, such as trying to make his pupils hear sounds of insects which are beyond the range of human hearing, for he is trying to multiply the power of inner perception by reaching away from objectivity toward intuition. He is trying to get his pupils to decentralize in order that the inner vision will tell that which it KNOWS to the outer vision which senses. He is endeavoring to cultivate the two-way directions of thinking and have them make the "round trip" from the invisible source to the visible effects.

The remarkable success he had so far made is indicative of the possibility of creating many geniuses and mystics in our schools and colleges instead of stultifying genius as our educational processes of teaching the outer senses to remember and repeat at the cost of creating parrot men who but remember and repeat.

I shall touch upon one other hypothesis which you have reasoned into being. Reasoning from your division of Consciousness into units, and the many units being ONE with each other and the ONE of their Source, you have conceived the idea of equality and identity of the undivided with the divided. Briefly, you have made the Creation equal to the Creator and identical with Him. You have made the expression - or record - of the IDEA equal and identical with

the IDEA. You may not realize it but you are giving the same reality to the illusion which simulates reality, as you give to reality itself. In other words, you are saying that the poem is the poet, the play is the playwright, the printed word which simulates an idea is the idea, that the motion of many atoms which simulate a man is the man, which are all like claiming that Creation is its Creator.

In this universe there is that which is eternally existent as ONE - and there is that which has no existence whatsoever, other than a simulation, or illusion of existence. The outer senses are a part of that illusion which they unhesitatingly accept as reality, even to doubting the eternal REALITY because they cannot sense it. It is very difficult even for the greatest of intellectuals to realize that the entire universe of seemingly real substances and objects is motion only, transient motion which in itself also seems, for motion itself is illusion and has no reality.

o the outer senses of man motion is as real to him as time is real to him, but time itself is only seeming. The limited senses of man sees only forward time, but the inner vision of advanced mystics, such as my husband who has a complete 360 degree spectrum range with no break between the outersensory and innersensory perception, can see forward moving time being simultaneously voided by its backward flow. To one whose outer-inner-sensory perception is complete, this is a zero universe of rest which never exceeds zero, for every seeming multiplication of it in thought-wave potential, is equally and simultaneously divided.

It would be futile to even breathe this thought to mass-man, for the measure of human comprehension is limited to the measure of his innersensory perception, which means his spiritual unfolding. It is the innersensory limitation which causes the outer senses to arrive at conclusions about facts of Nature which have no resemblance to Nature whatsoever.

Your December Calendar, for example, stated that "Sirius was born 100,000,000 years ago. The earth is about fifty times as old as Sirius." This unnatural conclusion is one of many hundreds of similarly untrue statements which continually shock my husband, and grieves him, for he would tell your group of astronomers that Sirius was billions of years old before even Arcturus was born. Also that our own sun is young, as compared with Arcturus and, in comparison, our earth is a product of yesterday. The same Calendar also states that "Astronomers have been thus led to the conclusion that Cosmic rays are confined to the local galaxy." To my husband this statement is as shocking as the equally archaic concept that the universe is expanding to a heat-death. And all of such statements are the result of man's present primacy which limits his sensory perception range to but a small slit of the whole spectrum of divided light.

One of the limited perception range of science searchers, which deeply grieves my husband every time he reads of millions being spent upon cyclotrons to find out what holds the atom together, is the fact that he could so easily give them that secret in ten minutes if they would but listen. His complete spectrum range makes it possible to "see" the entire process of Creation and the construction of matter in every detail from black zero to black zero of the divided spectrum of light-waves in motion. This fact is tragic in its import for my husband's great knowledge would be worth untold billions of dollars to science and industry if they would but listen to him. It might help you make your own wiser decision about your Cosmic unfolding if I tell

you WHY no one will listen to him, and why they would not comprehend him unless they were willing to utterly discard their very fundamental beliefs which - to them - are profound, but which - to my husband are as archaic as though written by mediæval sages.

You have rightly said that Jesus was the consummate scientist - and that if he came here again today he would not be recognized, as he was not in His own day. I know that my husband is the consummate scientist of this age, and he is not recognized as such because he is as far ahead of his day as Jesus was ahead of His day. They crucified Jesus on the cross because he overthrew their pagan beliefs. They crucify my husband by suppression because he would overthrow their primitive beliefs unless they did suppress him.

Dr. Russell was prepared for his supreme task since very early childhood. At the age of seven he had his first illumination - which means an extension of his innersensory perception. From that moment he was a transformed being. Also from that moment he found that he had to keep his silence about it, for everyone - including his own parents - thought him to be "queer" when he said many things which he thought everyone knew.

During his entire life, up to 49 years of age, he had forty two such periods of illumination during which his innersensory perception reached farther and farther toward that Mind-Soul center which Jesus termed "the kingdom of heaven" and Mohammed termed "Paradise." During each of those periods, which lasted from two to ten days, he was in a state of ecstasy which Buddha termed "the Brahmic Bliss." Each one of those experiences extended his inner perception appreciably. He once attempted to describe the inward journey to that Light, which Jesus referred to when he said "God is Light," as a journey through nine gates of the spectrum.

Finally, in May and June of 1921, the last great period of illumination came, accompanied by that blinding flash of light which characterized Paul's illumination. This was the third time that my husband had been so completely divided between the two aspects of sensation and consciousness. That light is a short circuit between the two lobes of the brain and the pituitary gland. It always occurs at death of everyone, and has often been photographed.

This last period of severance lasted for thirty nine days and nights, during which period he constantly visioned the whole process of creation, made many astronomical and chemical charts, and wrote forty thousand words of immortal literature - known as THE MESSAGE OF THE DIVINE ILIAD, without changing a word or a punctuation. In that Message is the essence of Creation. In the chemical charts is the complete cycle of the octave-wave orderliness of Creation. Likewise, he wrote down voluminous instructions regarding his plan for giving this Message to the world. One of these instructions commanded him to another seven years of silence before divulging his Messengership, and then a period of rehearsal for final action until 1946.

In 1926 he issued his complete charts and sent them to eight hundred scientists and universities, together with an elaborate work entitled THE UNIVERSAL ONE. The charts complete the very incomplete and inaccurate Mendeleef Table of the elements. His ability to "see" all around the spectrum made it possible to vision the three invisible space octaves which preceded hydrogen, and the six transuranium radioactive elements which completed the other end of the spectrum.

From this invaluable contribution to science there were but two acknowledgements out of the eight hundred. The first one was from a physicist instructor in a great college. He said: "Your charts are ridiculous and your writings are the insane wanderings of a diseased mind." The other was from the President of another institution of learning in which he stated that the charts "were the greatest contribution to science since Newton." The physicist apologized to him three years later when isotopes of hydrogen and heavy water verified his revised hydrogen octave, and the other statement brought to him a Doctor of Science Degree from a cultural group which was organized to legally bestow medals and degrees upon those who have made such contributions to the world as Thomas Edison, for example, who could not possibly receive one because of not having a university training. Edison had very little schooling, and my husband much less, for he was taken out of school at nine and put to work. In fact he knew nothing of science, and did not care to, until his last illumination in 1921. He never even looked at a text book of science until long after that day, and then only to learn the names for things, and their terms, in order to be able to talk the language of science.

All of his life he demonstrated the value of his Cosmic teachings by producing a prodigious amount of work in all of the five fine arts, in all of which he produced immortal masterpieces. He lived the lives of ten men as leisurely as though he were one, and in an ecstasy while working that only the genius-mystic knows. The only explanation he would give to people who marvelled at his versatility was that when one worked knowingly with God one could produce only masterpieces, and in a fraction of the time other men wasted upon nerve wracking experiment and guesswork.

Science did not recognize him as a scientist because his knowledge was not acquired in the legitimate traditional manner which universities give to men. After his first gift to science in 1926 he was widely quoted in the press for two or three years but when he continued to make statements which violently opposed and contradicted traditional scientific foundations, the press closed down upon him utterly.

It is not surprising that this would happen, for the following examples of his statements, made in public lectures and private conversation with many of the world's great scientists of that day, were as follows: "There is no such effect in Nature as negative charge, nor are there any negatively charged particles." "I see no resemblance in man's Cosmogony to God's Cosmogony." "The Bohr atom has no more resemblance to Nature than green cheese has to the moon." "The Bohr atom fantasy places electrons in orbits around inert gases in a mathematical variance in number. That is an utter impossibility in Nature. It also gives the inert gases a nucleal structure. That is also an impossibility in Nature. Nature does not work that way. The inert gases have no central structure, for they are centered by black vacuous holes." "If you want to know what holds the atom together you must first pierce the mystery of gravitation to discover that not one particle of matter in the universe has any power whatsoever to attract or repel any other particle." "You must some day recognize the fact that it is only matter and motion which are curved, and that they owe their curvature to the geometry of the wave-fields of space which meet each other throughout the universe in planes of zero curvature and transmit those forms to frozen matter in like crystal forms." "The Coulomb Law has no validity. Likes seek likes in Nature, not opposites. If opposites attracted each other why are positive and negative poles in a magnet as far apart as they can get, instead of together in the middle where they should be if the Coulomb Law is valid."

Then he was challenged about such statements as those of atomic structure and asked his foundation for such beliefs he has unwisely answered: "It is because I see them as you see me. I can see every atom and its way of forming, and I see very few which have solid mass centers, most of them being holes, and NONE OF THEM being group nuclei which is the basis of the Bohr impossibility."

Such statements went the rounds very quickly and marked my husband for crucifixion by suppression just as the throwing of the money changers out of the temple marked the last days of the consummate scientist of two thousand years ago. He continued, however, even against such opposition, to tell science that the key to all knowledge of physics is based upon a knowledge of gravitation which science admittedly knows nothing of today, and upon the true nature of electricity instead of the false concept of today. He also lectured upon the complexity of hydrogen before many science groups which were attended by the world's foremost scientists, such as Millikan, Michelsen, Whitney, Cooledge, Shapley, Pupin, Wilson, Tesla, Lee de Forest, Jeans and many others, some of whom he tried to win over in personal interviews.

He also worked as diligently with the great industrial laboratories, such as Union Carbide (with Cressy Morrison's hearty approval) with Westinghouse, (which appointed Dr. Harvey Rentschler to investigate) and with others whose research men opposed and obstructed his attempts because of their belief in his insanity and disbelief in his Cosmic Source of knowledge. Notwithstanding their opposition laboratories became very active in trying to prove or disprove his claim, when one day the world was amazed when one of them announced that hydrogen had been split into isotopes and my husband felt that he had, at last been vindicated. This was not to be, however, for the discovered hydrogen misnamed isotopes (they are full tones, not isotopes) were given other names than those he had given in his copyrighted charts, and all mention of him thus suppressed. Deuterium and tritium are two of the names which were changed. These most important new elements were not only unknown, but unsuspected before my husband's inner vision "saw" them in Nature and charted their positions. Likewise "heavy water" would never have been discovered.

Thus was his chart vindicated in this respect. Many years later the very same thing happened at the other end of the spectrum. His inner vision could see that there were still six more tonal efforts of Nature to complete her spectrum in material bodies. He saw six more isotopic divisions beyond uranium. Two of these were distinct - therefore vital. He named these two uridium and urium. The outer four he indicated on his charts by unnamed lines. He had told the world that uridium and urium would be a great danger to the world and it would be better if they were never isolated but when war made greater explosives necessary his charts were remembered and taken from their files. The result was the isolation of those two important elements and the four lesser ones. Again my husband's charts were vindicated and plutonium and neptunium were the names given them by the laboratory workers who verified their existence.

I tell you this to warn you that whatever you vision in your own Cosmic Light experience, which sets you ahead of your time, will mark you as "queer" - "crazy" - "fanatic" and even dangerous to the existing order. You must learn to be infinitely patient, never resentful or disappointed. Every mystic must expect crucifixion in some form and rise above it in being enabled to find supreme happiness in being a worthy messenger, for that is all that counts.

These body blows which would have utterly discouraged the average man, had very little effect upon my husband for he had been prepared for it by the instructions given during his last severance in 1921 which included these words: "Heed not thy crucifixion in the hearts of ten times ten million men. Truth lies beyond the crucifixion."

Two great minds in the scientific world, however, did believe in my husband's Cosmogony regarding the spiritually controlled electric universe and its relation to gravitation and magnetism, also they believed on his divine source of knowledge. These were Thomas Edison and Nicola Tesla. During the months of close association with Mr. Edison, as his official sculptor, he thoroughly convinced him of the unnatural concept of electricity, from which the untrue Coulomb Law arose, and of magnetism, which is entirely misconceived by modern science. Edison deeply regretted that his advanced age prevented him from helping to reverse present day concepts, for it would be the beginning of a hard fight. Nicola Tesla was a man of great spiritual vision. He was thoroughly convinced that the entire energy concept of modern science was basically wrong somewhere, and my husband's solution of that mystery - together with the mystery of gravitation which is the sole source of energy - won him over completely to the new thinking which bound the invisible and visible worlds together. He too was not only old, but feeble. He said to my husband: "I would gladly help you if I could, but it would be useless. Science would believe me to be as crazy as it thinks you are. Besides that, if you are right, every text book of science would have to be scrapped - and that would mean millions of dollars lost and every physics professor would have to learn his physics all over again. You are so hopelessly ahead of your time that I believe the only way your knowledge can be saved is to write it down and diagram it, then seal it in a sepulchre with instructions that it be opened in a thousand years."

And that is practically what he is doing. Being enabled to vision the whole of every effect in Nature, and not just a small section of its cycle, he is painting many pictures of these cyclic effects, electrical, chemical and astronomical, including the invisible geometric forms of wave-fields in space, and the visible effects which these space-forms control. Thus the birth and death of matter - the growth and formation of atomic systems of the entire nine octave range, from the inert gases to incandescent solids - the wave - the electric current itself, and its cathodes to anodes which center loops of force - all these are being diagrammed and pictured in their full spectrum range.

When an astronomer views a ring nebula he sees only the ring and its centering sun, while Dr. Russell "sees" the entire invisible moving mechanics of the electrical manufacturing process which creates atomic and star systems. Astronomers know that something holds that star in place but they do not know what holds it. They thus form false concepts of the effect based upon their sensing and reasoning. They see only a small fraction of the effect - the rest is black empty space. To my husband there is no black emptiness, there is a continuity of spectrum colors spirally following what science mistakenly calls "magnetic lines of force." Not only does he see what IS - he also sees what is GOING TO BE when that sun itself becomes another ring, or a series of rings. Nature's process of creating spheres from rings and the disappearance of spheres by the way of rings, and the spiral principle which controls the life-death cycles of all things, are not yet known to science but it is a beautiful process. The invisible universe is brilliant with all

the colors of the spectrum. There is no black in it. Each color, and its intensity, is the basis for a language which thinking Mind knows - the language of Light. Every deeply illumined mystic knows that language and can interpret into words, which are called "divine revelations," because they are inspired by inner knowing.

You, as an astronomer, will readily appreciate what an incalculable value such a Mind could be to astronomy. The astronomer is now handicapped by his limited vision. He is as a gardener would be if he could see only the blossoms in his garden, all else being black and formless - the leaves, stems and seeds all being invisible, even to the roots. Every star is as much a growth from its seed as a blossom is a product of its seed. Every such star has a fulcrum stem and branches, which are living fires. Their spectral movements and spiral inter-relations clearly tell the process of their creative powers. That vision of the invisible universe creating the drab visible one, is a sight which is more beautiful than the greatest poet could ever describe. It is a glory which is reserved for him only who has found the kingdom of heaven within himself - to which all things else have been added.

The dumb-bell nebula is not just accidental, or a freak form of Nature. It was once a great star, undergoing the process of being turned into a ring - which is the method Nature employs to return compressed spheres back into their source from which they emerged as rings. This fundamental fact of Nature has never been discovered as yet, although it is so clearly obvious. For the heavens demonstrate it in all of its various stages. It is part of a marvelously interesting and beautiful electric process which turns every pulsation of Nature's heartbeat inside-out and outside-in forever. The reason that principle has never been discovered is probably because the limited outer senses of man cannot see the continuity of movement which makes this gloriously beautiful interchanging effect of burning-dying Nature so clear to the mystic.

Some day, when your "seven year old jallopy" feels strong enough to transport you here I will show you many of these paintings and drawings which he started making when Nicola Tesla convinced him of the hopelessness of trying to get men of this primitive age to think in terms of three thousand years hence, or even one thousand years. The spiritual inner vision unfolds slowly. One thousand years is not much in man's spiritual unfolding, for he is still the primitive killer of his fellow man just as he had been killer of man for thousands of years. When the consummate teacher of man of two thousand years ago said: "Father forgive them for they know not what they do," He meant just that. And the same thing applies in this pagan-barbarian age which we think so advanced.

It is a pity, nevertheless, that such a Mind as that must be lost to this civilization, a Mind which knows every detail of the principle of transmutation - and who also knows the stars beyond all men - and the growth and disintegration cycle in the construction of matter. He is 85 now and is preparing to paint and diagram each of the atomic series, beginning with the inert g's of each octave and showing their growth through each of their octave tones to their amplitude positions where carbon, silicon and cobalt have arrived - and how they lose their metallic qualities electrically, and can regain them electrically - and why they are divisible into isotopes at will of one who knows - and why new metallic isotopes of incalculable value await discovery between boron

and carbon, and on either side of silicon - and especially why space consists of geometric forms of zero curvature to control a visible curved universe - and endless such printings, drawings and diagrams which he will continue to make as long as he can to seal in this imperishable marble palace until mankind is ready for their comprehension.

That is one of the purposes of this foundation. That is its long range purpose but its day-to-day purpose is to discover and aid those whose inner vision can be quickened, to hasten the day of man's unity with man. We have thousands of pupils all over the world who desire to awaken their inner vision which leads to Cosmic Consciousness. These are gradually becoming aware of their inner Light. That is why we are so sympathetic and hopeful of results from Dr. Rhine's work at Duke University which would have been unthinkable for any university to attempt even thirty years ago.

All such preparation will hasten the day of man's recognition of his Divinity which will alone destroy the evil which exists only in the concept of physical man who has become evil by thinking himself evil. To that very end I wrote the book which has awakened such inspiration in you. I wrote it to awaken the Light in tens of thousands like you who also desire that awakening. It is but one supreme effort but its power is being felt already - even though off the press only three months.

Our thousands of pupils whole heartedly believe in their ability to obtain knowledge Cosmically. It was their deep desire which borned my book. I felt their need as a world need and could not help writing it. That world desire consumed me with burning fire until I fulfilled that need, if you alone were the only fruit of it by having your first awakening illumination. When you consider that the world has only known thirty or so mystics in the thousands of years since the dawn of Consciousness, and only three of these being consummate ones, the advent of a new one is of vast import. You will be pleased to know however, that there are many like you who have recognized that inner Light in them through the mirrors of it which we have been able to reflect into their inner Selves.

These many students of ours whole heartedly believe that they can obtain knowledge Cosmically, as my husband and I have thus obtained it. They thoroughly believe that they can "talk to God" inspirationally and intuitively as they talk to man physically. These students have taken God into their lives and that is why they progress. Science has shut God out of its consideration and that is why it is destroying itself and man with it. Science believes that God cannot be proved by laboratory methods, but we know that He can thus be proved and His identity verified. My husband has known of His identity and Presence all his life and is fully able to define Him scientifically so that others would know where to locate His Presence in Nature - or OMNI-Presence. I should say, for God is everywhere, in every thing in all this universe. The time will come in man's spiritual unfolding where he can no longer say: "I do not believe in God because I cannot see Him" for God will then be as visible to Mind-eye as a mountain is now visible to body-eye. In the meantime G O D CAN BE KNOWN - and that is sufficient unto this day.

We make Him become known to our students through our Home Study Course which we have both written together. It is illustrated by nearly three hundred of Doctor's diagrams and paintings, which reveal God's ways and processes.

and their relation to a way of life out of which a Living Philosophy is evolving for them. This makes them masters of their own destiny and gives them command of Universal Law through knowledge of how to obey Universal Law.

In closing I wish to express the hope that this lengthy explanation of the necessity for you to attain the power of silence lest you lose what you have gained by the miracle of what has happened to you. It is not easy to realize that the greatest glory which can come to man can be the means of his undoing. It is true, however. Jesus was crucified because of it, but he remained silent until ready to fulfill His purpose, but to invite crucifixion before one is ready to fulfill his purpose is to see that purpose defeated.

Knowing in my heart that you will fully understand the purpose of this letter in guiding your unfolding, and assuring you that we stand ready to again guide you as one Illuminate must always guide a novice who needs guidance, and with our best wishes for world-progress during this coming dangerous year,
I am,

Sincerely yours,

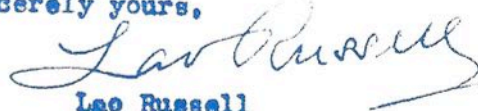

Lao Russell

P.S. I am enclosing copies of the two charts which Dr. Russell gave to science in 1926, showing the three octaves proceeding hydrogen and the six trans-uranium elements at the opposite end of the Mendeleef table. *lol*

June 8, 1961

Dear Robert:

Ever since your departure your warm presence has permeated this house and filled our hearts and minds with the strong conviction that your coming to this mountain is another sign to us of God's control of the destiny of man by bringing His messengers together to pattern that destiny.

Your letter, which expresses the warmth of your beautiful soul also makes us aware of our oneness in spirit with you. We cannot help but feel that the time has almost come when you will be here with your beloved sharing in God's great plan for the saving of all mankind.

The spiritual essence of your fine manuscript on the story of RADAR struck us both forcibly and we found ourselves discussing this at length immediately after your departure. This too seemed all wound up with our combined destiny for the tremendous import of radar was brought home to us by you and as we were reading Kenneth de Courcy's report from England in his current Intelligence Digest - in which he likens this crucial period to 1939 - we were acutely reminded of Chamberlain's order to make radar improvement as first import in England's fight for survival when he gained that year's reprieve which truly won the war.

Kenneth de Courcy also confirms the brief time element left to us which you mentioned - namely 1962 - for he stated that Khrushchev said there would be an economic collapse in the U.S.A. in either the latter part of '61 or the beginning of '62. We are all aware that dramatic scientific accomplishments could more than offset this for the world's very survival rests now on scientific knowledge that would make war obsolete. We know that God borned us and gave us this knowledge for just this purpose and we cannot help but feel that you are part of God's great plan for this vital day. That is why we felt such love for you and you felt so much a part of us in 22 brief hours.

No time can be lost in perfecting RADAR, which can only come through knowledge of the wave principles of Nature which are essential to the complete success of Nike Zeus, ICBM's and all missile systems as they will be to our wireless power projection system. Only today we heard of another thirty million dollar Atlas failure which we feel confident could not have happened if our knowledge had been made use of.

This letter started with the intent of expressing our happiness upon receipt of your inspired letter but the import of radar because of the time element set by Khrushchev for our surrender to slavery, tempted us to lengthen it beyond its intent and answer some of the questions you asked about the application of our power multiplication principle to radar. Also, having used the phrase "perfect radar" you might naturally ask what we mean by that.

We would like to fully answer that question for you but we will explain our meaning and answer your question very sketchily and supplement them later.

By "perfect radar" we mean one which so perfectly simulates the radar of Nature that every action at any point in the universe is radared to every other point without effecting the clarity of its visual image. All of Nature's macrocosmic patterns fold inward to microcosmic proportions until they entirely disappear into zero as sound disappears into silence, without effecting its pattern. In this manner dynamic actions are as omnipresent as the static light from which they spring. A good example of our meaning is the perfection of pattern in electron micrographs enlarged to 60,000 diameters.

A ship does not lose its pattern by being 3,000 miles away and the perfect radar should be able to bring it to macrocosmic scale with television clarity of detail. The present radar does not do that even with a ship or plane three miles away. It appears as a blurred image on the luminescent screen. The reason for this is that the pulse beat of Nature which the pulse radar is intended to emulate, is not thus emulated in the present system. All down the line of its entire system, from modulator and magnetron to deflector, antenna and screen there is a lack of emulation of the wave mechanics of Nature. These accumulate in lack of precision and clarity of vision.

We feel confident that our new radar system will eliminate these faults. We believe that the prime errors of the present system lie in the deflector and the bowl-shaped antennas. The deflector is intended to extend a light beam from a point to an area 90° azimuth from the direction of the beam. It does that, but the consequent distortion makes a sharp focus impossible, and the slightly curved screen adds to this distortion. That is not good optics.

Our screen would be of zero curvature and emulate that principle of optics which is familiarly known as the pin-hole camera, in which a flat sheet of black paper is punctured with a pin-hole and placed in the path of the beam of light. Diffraction rings immediately extend from that ray at a 90° angle to form an invisible bi-convex lens which focuses directly on that beam. If that beam is deflected, however, a badly blurred focus would be the inevitable result. Our plan calls for another unit to cause a true focus on the screen rather than ahead of it.

We must realize that all dynamic motion of light is curved, but the control of motion lies within planes of zero curvature. That is why our antennas will have no curvature.

To know how a huge mountain range can penetrate a pin-hole and register its complete image upon the other side of it is to know the nature of light. Anyone can perform that miracle but the greatest intellects of the world cannot reveal the mystery of the omnipresence of light and of all effects of motion created by light waves which make this miracle possible. That omnipresence of events is the basis of all radar and knowledge of its secrets is the basis of our radar.

A good description of the wave would be to liken it to a spherical diaphragm enclosed in a "cosmic" cube-shaped camera which closes in varied time frequencies to compress large spherical areas of cold, invisible light into small spherical areas of hot visible light to create this universe of spectrum divided and conditioned matter. The diaphragm then opens to reverse the process. Thus it is that the gravity controlled light cycle of generation and radiation sequences unfolds microcosmic patterned ideas into macrocosmic ones in Nature's cosmic radars to create this optical photo-synthetic universe of living-dying things.

An important part of this process is that the spherical diaphragm closes and opens with four "changes of speed gears" which give us the octave principle of four pairs to every wave. A consequent feature of this phenomena is that the forming image is always surrounded by light rings, and the perfect radar will emulate that principle by always finding a perfect image in the focus of rings upon its screen.

The difficulty of trying to put into a few words so ponderous a subject is that each statement of explanation is but a step which demands taking another explanation for another step ad infinitum. The antennas of Nature, for example, are constructed upon tetrahedral lines which give perfect scanning for 360 degrees without necessity of rotating because two of the six tetrahedrons which constitute the cubic cameras of Nature, control only diffraction rings of the closing of the diaphragm and focus upon the wave axis, while the other four control its opening in rings which extend their sequences upon the plane of the focal equator like those we see in Saturn. It would call for too many pages to even briefly explain and diagram these many steps, as well as the many inconsistencies which both the electrostatic and magnetic C.T.A.'s contain. The so-called magnetic field of the latter assumes a premise which does not exist in Nature, but that, also, needs diagrams for clarifying.

The sum total, however, of these discrepancies and assumptions which are based upon theories and arrived at by deductive reasoning, causes the lack of perfection in the existent radar system. Actually, it is amazing that the present system in spite of its faults has been able to make one hit out of forty. If this average is not vastly reduced before an atomic war takes place the loss of many cities would be the price.

It certainly was not our intention to write such an epistle to you but your visit which touched such a deep chord in our consciousness - plus the somber news of the ever-growing need for greater urgency in scientific development, brought into focus what America's power through perfected radar and power projection could mean in saving the world from self-suicide and in establishing world peace forever. To us, as we told you during your visit, your coming to God's mountain top was like another chain in our united destiny and we know that an intangible part of you will forever be here and a way will present itself whereby you can return and aid in bringing God's message to man. Thus, will you know your own personal fulfillment as we two have found ours in our united work for God and our fellow man. May that day be soon as we desired and wished for you on the first day of your own special New Year.

With our dearest love, we are

Sincerely yours,

Lao and Walter Russell

P.S. Perhaps you have found among your books of poems John Burrough's WAITING - if not here are the four stanzas I told you I had repeated daily for years until "My own did come to me." Stick these in the little birthday card and through the years to come I know they will remain a precious memory.

WAITING

by John Burroughs

Serene, I fold my hands and wait,
Nor care for wind nor tide nor sea;
I rave no more 'gainst time or fate,
For lo! my own shall come to me.

I stay my haste, I make delays--
For what avails this eager pace?
I stand amid the eternal ways
And what is mine shall know my face.

Asleep, awake, by night or day,
The friends I seek are seeking me,
No wind can drive my bark astray
Nor change the tide of destiny.

The stars come nightly to the sky;
The tidal wave unto the sea;
Nor time, nor space, nor deep, nor high,
Can keep my own away from me.

Patent Papers

Sept. 8, 1942.

P. A. GUILLES ET AL

2,295,209

FUEL FOR INTERNAL COMBUSTION ENGINES

Filed Dec. 27, 1939

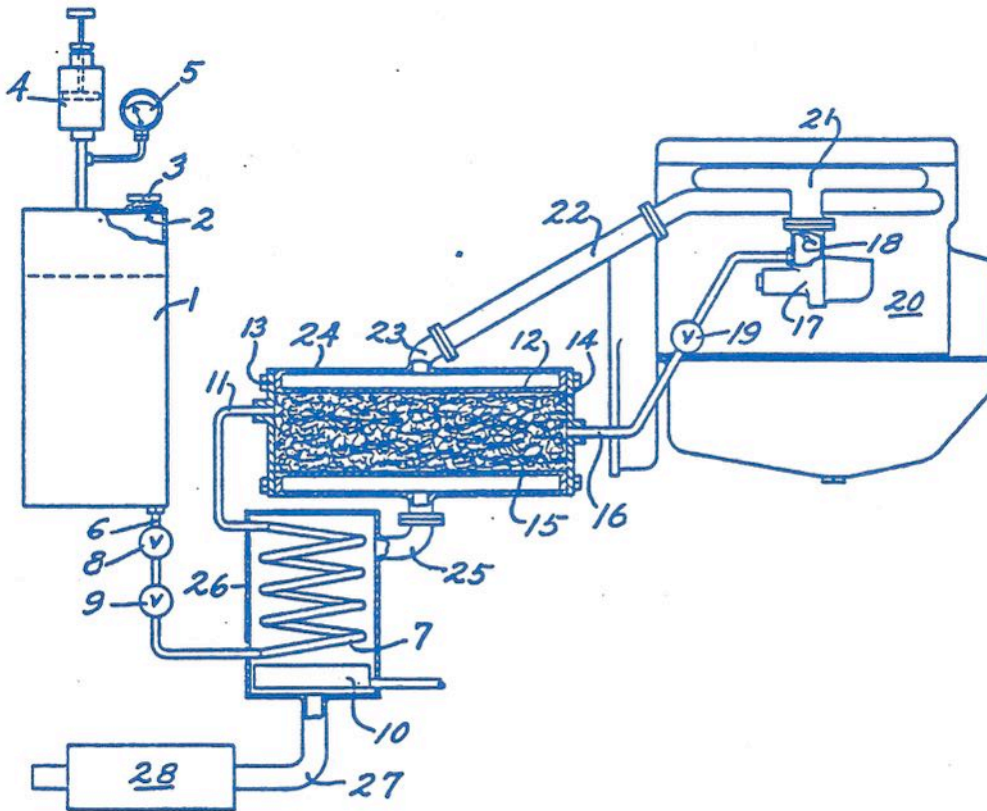

INVENTORS,
PAUL A. GUILLES
BASIL RAWES VAUGHAN.
BY
A. Schupp
ATTORNEY

UNITED STATES PATENT OFFICE

2,295,209

FUEL FOR INTERNAL COMBUSTION
ENGINESPaul A. Guiles and Basil Rawes Vaughan,
San Francisco, Calif.

Application December 27, 1939, Serial No. 311,152

2 Claims. (Cl. 123—3)

The present invention relates to improvements in fuels for internal combustion engines, and its principal object is to provide a method of and means for rendering water available as such a fuel.

More particularly it is proposed to use a bed of steel wool or other oxidizing agent for decomposing water which has been turned into steam and for setting free hydrogen to be used as fuel for the engine.

It is further proposed to provide a convenient and simple apparatus whereby water is first heated to produce steam and the steam is passed through an enclosed body of steel wool for liberating the hydrogen, which is delivered to the engine, in the presence of atmospheric air or another suitable combustion supporter, while the exhaust gases from the engine are used to supply heat to the steel wool and the heater so that the entire apparatus may be run without the aid of an external source of heat except for the initial stage.

Further objects and advantages of our invention will appear as the specification proceeds and the novel features thereof will be fully set forth in the claims hereto appended.

The preferred form of our invention is illustrated in the accompanying drawing, in which the invention is shown diagrammatically.

While we have shown only the preferred form of our invention, we wish to have it understood that various changes or modifications may be made within the scope of the claims hereto attached without departing from the spirit of the invention.

Referring to the drawing in detail, our invention comprises, in its preferred form, a vessel 1 for holding water which may be filled to a suitable height through an opening 2 adapted to be closed by a cap 3. Suitable pressure may be produced in the tank through a pump 4 and may be measured through a gauge 5. While we do not wish to confine ourselves to a definite degree of pressure, the same should be sufficient to force the water and steam subsequently created through the system and we find in actual practice that three or four pounds are ordinarily sufficient for our purposes.

A pipe 6 connecting with the bottom of the vessel leads to a heating coil 7 and may be controlled through a shut-off valve 8 and a needle valve 9. Any suitable means such as a burner 10 or electrical heating means may be used for initially heating the coil and for turning the water passing there-through into steam.

The coil 7 connects, through a pipe 11, with a container 12, which is preferably made in the form of an elongated tube, and which is provided with movable end plates 13 and 14. This container is made to receive a body of steel wool, indicated at 15, and the steam is made to pass through the same from end to end.

An outlet pipe 16 connects the end opposite the point of entry with a conventional type of carburetor, indicated at 17, preferably immediately below the throttle valve 18 thereof. The carburetor may be of any suitable construction. The pipe 16 is controlled by a suitable valve 19.

The carburetor is connected to the engine 20 in the conventional manner. The engine may be of any suitable type and, if desired, the carburetor may be connected, in any conventional manner, to a suitable gasoline fuel supply so as to be capable of operation by gasoline, particularly for starting purposes.

The intake manifold of the engine is indicated at 21 and the exhaust of the engine at 22. The exhaust gases of the engine are preferably utilized for providing the necessary heat for the body of steel wool and the coil. To accomplish this the gases constituting the products of combustion, are guided through pipe 23, into a jacket 24, surrounding the steel wool chamber and, after having passed through the jacket, are guided through a pipe 25 into a housing 26 surrounding the heating coil 7 to be finally ejected through the pipe 27 and the muffler 28.

In operation the water from the container 1 passes to the coil 7 where it is converted into steam, and the latter passes into and through the body of steel wool 15. The latter oxidizes in the presence of the steam, and takes oxygen from the latter, thereby freeing the hydrogen contained therein. The hydrogen passes through the pipe 16 into the carburetor below the throttle valve and joins with air entering through the carburetor to form a fuel for the engine.

For initial heating, the engine may be started on an auxiliary supply of gasoline in the conventional manner, until the exhaust gases have heated the body of steel wool and the coil sufficiently to convert the water into steam, whereupon the operation may be switched over to the water tank in the manner previously described.

If it is not desired to carry an auxiliary supply of gasoline, for starting purposes, special heaters or burners of any kind, may be relied on to furnish the initial heat for the steel wool and the coil.

It is apparent that other materials may be

substituted for the steel wool, such as iron filings, scrap iron or other oxidizing agents, which will take up oxygen from the passing steam and will liberate hydrogen. We find that after a certain amount of use the steel wool becomes heavily oxidized and has to be renewed.

The coil 7 is merely shown as one suitable means for converting the water into steam, and any other suitable means may be substituted for the same. During normal operation, the exhaust gases arranged to pass in heat-exchange relation with the steel wool and the coil are sufficient to furnish the necessary heat required.

The engine may be of any suitable kind. We have carried on our experimental work with a conventional automobile engine of the internal combustion type, using a spark for exploding the mixture within the combustion chamber.

We claim:

1. A fuel feeding apparatus for an internal combustion engine, comprising a tank for holding water, and having means for placing the water under pressure, a closed conduit connecting the tank and the engine intake, a coil in the conduit for receiving water from the tank, means for heating the coil whereby the water is turned into steam, a container for steel wool in the conduit

and mounted to receive steam from the coil outlet and to discharge into the engine intake, means for heating the container whereby the steam passing over the steel wool is reduced in part for producing free hydrogen and whereby mixed steam and free hydrogen is fed to engine intake, and means for adding air to the mixture after it leaves the container.

2. A fuel feeding apparatus for an internal combustion engine, comprising a coil, means for forcing water therethrough under pressure, means for heating the coil whereby the water is turned into steam, a container for steel wool having connections to receive steam from the coil outlet and to discharge into the engine intake, means for heating the container whereby the steam passing over the steel wool is reduced in part for producing free hydrogen and whereby mixed steam and free hydrogen is fed to the engine intake, and means for adding air to the mixture after it leaves the container, the water feeding means, the coil and the steel wool container with their connections forming a closed conduit whereby all the water fed into the conduit is made to pass through the same.

PAUL A. GUILLES.

BASIL RAWES VAUGHAN.

April 25, 1933.

W. HOLLAND

1,905,627

APPARATUS FOR ELECTROLYSIS

Filed Sept. 24, 1930

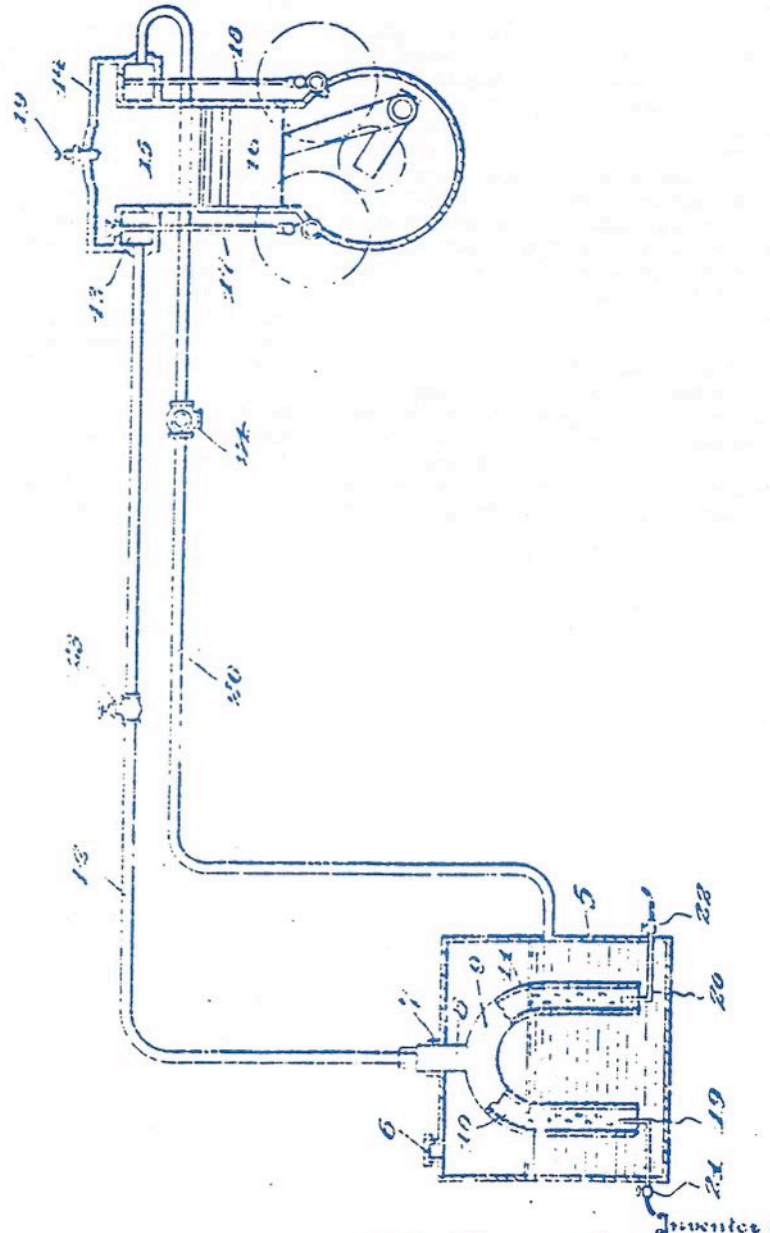

Walter Holland.

284 *Hortwell*
Attorney

UNITED STATES PATENT OFFICE

WALTER HOLLAND, OF WASHINGTON, DISTRICT OF COLUMBIA

APPARATUS FOR ELECTROLYSIS

Application filed September 24, 1930. Serial No. 484,147.

This invention relates to a method for converting molecular energy into mechanical energy, and an apparatus therefore.

Primarily, the object of the present invention resides in the provision of an apparatus of the above-mentioned character wherein the decomposition of a liquid, such as water, is effected by electricity, for the liberation of its gases.

Another object is to provide means whereby said gases, under control, may be introduced as a detonating mixture into a confined space, such as the explosive chamber of an engine, and subjected to the influence of an electric spark for the great disengagement of heat and acquired expansive force.

Still another object of the invention is to provide means whereby said liquid may be decomposed, as aforesaid, and the liberated gases collected for passage to said confined space.

A still further object resides in the provision of means whereby the products of the detonating mixture may be returned to its source of supply or exhausted into the atmosphere.

With these objects in view, together with others which will appear as the description proceeds, the invention resides in the novel formation, combination, and arrangement of parts, all as will be described more fully hereinafter, illustrated in the drawing and particularly pointed out in the claims.

The drawing illustrates an elevation of the apparatus, partly in section, and diagrammatically showing the arrangement of parts.

Referring now more in detail to the accompanying drawing, let 5 indicate a receptacle of suitable proportions and adapted to contain a supply of liquid, such as water, said receptacle having a filling opening 6 for the replenishment of its contents as needed.

It will be noted that said receptacle is suitably apertured, as indicated at 7, through which projects the extension 8 of the vessel 9, the latter including members 10 and 11 having their lower ends open and spaced from the bottom of said receptacle 5. Dur-

ing the fabrication of said receptacle, said vessel may be built therein if desired.

Leading from said extension 8, of said vessel 9, is a conduit 12, its other end being suitably connected to the intake chamber 13 of an engine, generally denoted by the numeral 14 and it will be observed that said engine includes the usual chamber 15, piston 16, intake valve mechanism 17 and exhaust valve mechanism 18. While the drawing shows a well-known type of internal combustion engine, it will be understood that the same is illustrative, rather than restrictive, in that my improvement is operable in connection with any type of engine adapted to be operated by the expansive force of a gas or the like.

Reverting now to said receptacle 5, it will be observed that electrodes 19 and 20 are fitted within said members 10 and 11, which extend to binding posts 21 and 22 respectively, to which latter may be connected suitable wires leading from a convenient source of electricity. (not shown). In view of this arrangement the interposition of the above in an electric circuit causes a decomposition of the water and the liberation of hydrogen at the negative electrode 20 and the liberation of oxygen at the positive electrode 19. As the bubbles of these gases rise in said vessel 9 they are collected within the extension 8 and passed, under control, to said inlet chamber 13 by way of conduit 12, valve 23 being interposed in the latter to regulate the passage of said gases.

As heretofore pointed out, the gases are introduced as a detonating mixture of hydrogen and oxygen into said inlet chamber for subsequent passage into the chamber 15 of said engine 14, and as is well-known said mixture comprises two volumes of hydrogen and one of oxygen.

When said mixture is subjected to an electric spark a great disengagement of heat ensues, said liberation of heat amounting to 68,924 thermal units, and since each unit is equivalent to over 1300 foot-pounds, the acquired expansive force may be utilized to operate a moving body such as a piston.

In the drawing the piston is shown as op-

erating to draw in the above-mentioned detonating mixture, and it will be observed that the inlet valve mechanism 17 is operated to permit the passage of said mixture into the chamber 15. As the piston rises to compress this mixture, both valve mechanisms 17 and 18 are operated to close the inlet and exhaust ports and shortly after the piston reaches its highest point, the charge of the mixture is subjected to a spark from the plug 19, which is connected to a suitable source of electrical energy, (not shown), and the working stroke then takes place, both valves remaining closed. After said working stroke, the piston rises and the exhaust valve opens to permit the products to escape through the conduit 20 back to the receptacle 5, said products being now in the form of a steam. If desired a three-way valve 24 may be interposed in said conduit 20, which is susceptible of operation to discharge the products into the atmosphere.

Having thus fully described this invention, I hereby reserve the benefit of all changes in form, arrangement, order, or use of parts, as it is evident that many minor changes may be made therein without departing from the spirit of the invention or the scope of the following claims.

I claim:

1. A device of the class described comprising a receptacle, a supply of liquid within said receptacle, a vessel positioned within said receptacle, said vessel including a pair of members having their open ends extended into the liquid and spaced from the bottom of said receptacle, said members uniting to present a gas-collecting chamber with the receptacle and electrodes of opposite polarity, one electrode being positioned within each of said members of said vessel.

2. An electrolyzer adapted to be positioned in a receptacle containing a liquid, and comprising a U-shaped body portion presenting a pair of members having their open ends extended into the liquid, there being a gas-collecting chamber positioned above the top of said members, an extension leading from said chamber and electrodes of opposite polarity, one electrode being positioned within each of said members.

In testimony whereof I affix my signature.
WALTER HOLLAND.

F. A. OSOWSKI,
PROCESS OF MAKING GAS.
APPLICATION FILED SEPT. 28, 1917.

1,259,898.

Patented Mar. 19, 1918.

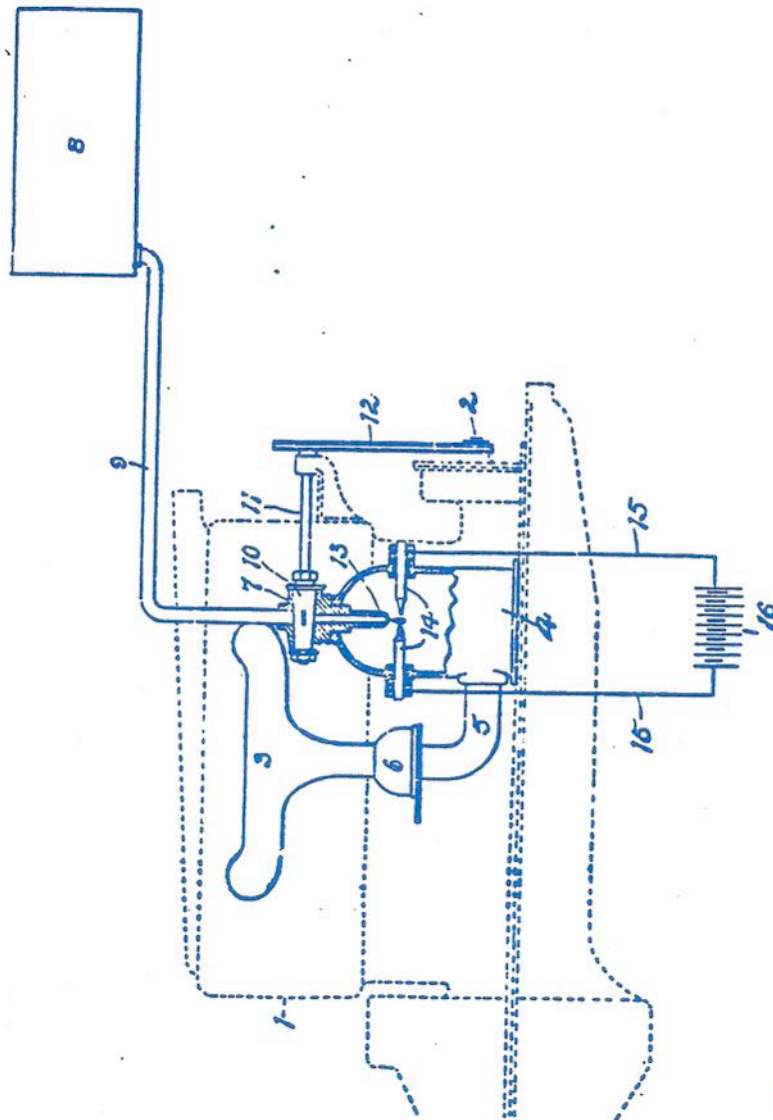

Inventor

Witness
Charles Kelly
Charles W. Stauffer

Felix S. Osowski
Richard W. Smith

Attorney

UNITED STATES PATENT OFFICE.

FELIX A. OSOWSKI, OF DETROIT, MICHIGAN.

PROCESS OF MAKING GAS.

1,259,898.

Specification of Letters Patent.

Patented Mar. 19, 1918.

Application filed September 28, 1917. Serial No. 193,844.

To all whom it may concern:

Be it known that I, FELIX A. OSOWSKI, a citizen of the United States of America, residing at Detroit, in the county of Wayne and State of Michigan, have invented certain new and useful Improvements in Processes of Making Gases, of which the following is a specification, reference being had therein to the accompanying drawing.

This invention relates to a process for separating fluids into their constituent gases electrically, and its object is to provide a process which may be employed in connection with an internal combustion engine to supply the gaseous fuel thereto as it is consumed in the engine, and further, to provide a process which may be conveniently controlled or regulated to produce just the amount of gas required, and in which a maximum of gas is produced with the consumption of a minimum of electrical current.

With these and other ends in view, the invention consists in introducing small quantities of matter which may be separated into its constituent gases by means of an electric current, between spaced electrodes within an electric circuit in such a manner that said quantities will each bridge the gap and close the circuits, causing the current to pass through each quantity and separate or transform the same instantly into its constituent gases. The invention further consists in the regulation of the volume or frequency of introduction of the matter between the electrodes to control the amount of gas produced, and in providing certain other new and useful features, all as hereinafter more fully described and particularly set forth in the appended claims, reference being had to the accompanying drawing which is a diagrammatic view illustrating a method of and means for carrying out the invention.

While a specific arrangement and construction is shown in the drawing, it will be understood that the same is merely illustrative of one form and arrangement of apparatus for carrying out my process and that I do not limit myself to any particular apparatus or arrangement thereof for performing my invention.

In the drawing 1 indicates an internal combustion engine, 2 the usual cam shaft thereof and 3 the intake manifold. A gas chamber 4 of any suitable form or construc-

tion is located adjacent the manifold and is connected thereto by a pipe 5, an air inlet valve 6 of any suitable form being interposed between this pipe and the inlet end of the manifold to admit air for admixture with the ingoing gases. At the top of the chamber 4 is a valve 7 for controlling the feeding of water or other liquid into the chamber from a suitable source of supply, such as the tank 8 through a pipe 9. The valve may be operated from the cam shaft or other moving part of the engine in timed relation to the engine in any suitable manner as by providing the rotary plug 10 of the valve with a shaft 11 which is driven by a sprocket and chain connection 12 with the cam shaft 2, to feed the fluid in measured quantities and at regular intervals into the chamber 4 through a discharge nozzle 13 extending downwardly in the chamber from the valve. Mounted in the sides of the chamber 4 and electrically insulated therefrom are electrodes 14 with their inner ends opposed and spaced apart to form a gap which is located directly below and adjacent to the discharge end of the nozzle 13. These electrodes are connected within an electrical circuit 15 connected to a suitable source of current indicated at 16.

The tank 8 is filled with acidulated water or other liquid having electrical conductivity and this fluid is fed into the chamber 4 in very small quantities so that it will issue from the nozzle 13, preferably drop by drop and as this nozzle is located adjacent to and directly above the gap between the electrodes 14, each drop as it enters the gap closes the same and the electrical current instantly passes through the drop and in doing so instantly decomposes the liquid, changing the same into its constituent gases which are confined in the chamber, and upon inspiration of the engine are drawn therefrom through the pipe 5 and manifold 3 and in passing there-through are mixed with the proper amount of air drawn in through the air inlet 6 to form combustible charges. By regulating the size and frequency of the water charges by means of the valve 7, the necessary volume of gas to supply the engine will be made just as it is used, each drop of liquid being converted into gas instantly so that none will remain in the chamber and the gas so made being immediately drawn from the chamber and consumed in the engine.

The electrodes are spaced just far enough apart to prevent the current from jumping across and so that each charge of liquid when it drops between them will complete the circuit by closing the gap. The circuit is therefore normally open and current is consumed only during those intervals in which the gap is closed by the drops or small quantities of liquid. A minimum of current is therefore required and as the volume of liquid is so very small and the current is concentrated therein, each charge or drop is instantly decomposed or converted into gas by a current of comparatively low voltage and amperage.

Obviously any desired number of pairs of electrodes and water feeds may be employed if it be found that a sufficient volume of gas to supply the particular engine is not produced by one pair of electrodes.

This process of separating liquids or other matter into constituent gases, comprises the introduction of small quantities of matter between spaced terminals of an electric circuit, to close the circuit and cause decomposition and liberation of the gases by the momentary passage of the current therethrough, and it is not limited to any particular means for carrying out the process or any particular construction or arrangement of apparatus.

What I claim is:—

1. The process of making gases which consists in introducing limited quantities of matter between the spaced terminals of an electric circuit to cause current to pass through and instantly liberate the gases of each quantity introduced.

2. The process of converting matter into its constituent gases which consists in causing a limited quantity of the matter to form the electrical connection between the terminals of a normally open electric circuit.

3. The process of converting liquids into their constituent gases which consists in causing the liquid in separate small amounts to intermittently pass into the gap between spaced terminals of an electric circuit and form the conductor for the current therebetween.

4. The process of making gas electrolytically which consists in intermittently feeding limited quantities of matter between spaced terminals of a normally open circuit

to cause each quantity of matter to be converted into its constituent gases by the momentary passage of the current.

5. The process of making gas by electrolytically changing liquids into their constituent gases which consists in providing an electric circuit with terminals spaced to provide a gap in the circuit and feeding small bodies of the liquid into the gap.

6. The process of making gas by electrolytically changing liquids into their constituent gases which consists in providing an electric circuit with spaced terminals and feeding liquid drop by drop into the space between the terminals, each drop forming a conductor for the current between the terminals.

7. The process of making gas by electrolytically changing liquids into their constituent gases which consists in feeding the liquid in small bodies intermittently, into a gap between terminals of an electric circuit to momentarily close the circuit by each body of liquid and cause the body to be instantly decomposed by the passage of current therethrough.

8. The process of making gas by electrolytically decomposing liquid, which consists in providing an electric circuit with terminals spaced to form a gap in the circuit and provide a normally open circuit, and intermittently feeding liquid into the gap in bodies of sufficient size to bridge the gap.

9. The process of electrolytically producing gas from water which consists in providing a normally open circuit having a gap between terminals thereof and feeding acidulated water intermittently, drop by drop into the gap within a chamber.

10. The process of electrically producing gas from water which consists in providing an electric circuit having spaced terminals forming a gap, acidulating water, and measuring and intermittently feeding the water, drop by drop, between the terminals to bridge the gap and cause the current to flow through and decompose each drop separately.

In testimony whereof I affix my signature in the presence of two witnesses.

FELIX A. OSOWSKI

Witnesses:

ANNA M. DORR,
KARL H. BUTLER.

Some of our current state (+ & -) Almost a half century after publication of The World Crisis, Atomic Suicide?, etc.

Health & Healing - "If the results of new stress tests in rats hold true for humans, it appears that cuddling kids during their early years will better enable them to handle stress as adults. Reported in the *Journal Science*, the tests were done by McGill University researchers, who examined the licking and grooming of rat pups by their mothers. Pups who got extra cuddling in their first two weeks of life (roughly akin to humans' first three years) dealt better with stress as adults. Noting neurological similarities between rats and humans, the researchers theorize that their findings may have implications for how we raise our children." *New Age Journal Jan / Feb 1998*
I guess we do need to have such studies to become aware of the obvious, and I always suspected that their were neurological similarities between rats and certain humans, and now I see its in all of us!

Earth Changes - Starving seals and sea lions are wadding ashore in the CA coast as their food supply has been disrupted by El Nino. AP 12/11/97
Typhoon Paka's gusts of up to 236 mph breaks the earth surface wind record set atop MT Washington in NH 63 years ago. USA TODAY 12/18/97
More tropical forests burned in 1997 than at any time in recorded history, at least 80% set deliberately , many by companies seeking bare land for development. AP 12/17/97. The long Valley Caldera in the Mammoth Lakes region in central CA has experienced increased quake activity as of summer of 1997 report. This is near the VA/NV border area that Gordon Michael Scallion has predicted a volcano will appear. Scientists monitoring the area say it is because of earth core/ magma movements but they don't know if it will reach the surface. *Earth Changes Report Jan/ Feb 1998*. Gordon believes that the weather will account for the main loss of property and life during the earth changes time of tribulation we are presently in. He also thinks the El Nino will continue and floods this spring will be more severe than those in 1993 that he did warn us about in 1992. Lao Russell told me several times that "The weather will bring humanity to its knees."

Government/Politics - With two US aircraft carriers at his doorstep Saddam Hussein effectively thumbed his nose at Bill Clinton and Clinton did nothing. Richard Maybury of EWR believes this was a major turning point in world history. He believes that 90% of the US backed oil dictators and monarchies have now switched sides to the New Axis of Arab countries. After Clinton did nothing he called a meeting of his Arab allies in Qatar and they boycotted it. But, these same "allies" did attend the Islamic conference - in Iran. 5 years ago Iran's hosting this conference would have been unthinkable. At the conference the keynote address given by Iran's supreme leader called for all Islamic nations joining together to get the US Govt. out of the Persian Gulf. Maybury believes its a 90% chance of the biggest, most senseless oil war yet within three years. *Early Warning Report Jan. 1998*.

Religion - The Pope's envoys expressed discontent to the Cuban Govt. upon finding hidden microphone "bugs" in the quarters the Pope was supposed to use on his historic first visit to the Cuban communist Govt. country. The Cubans admitted they were indeed there, but claimed they were leftovers from the days of the old dictator Batistas' regime. *Boulder Camera* January 1998. Randy Weaver has written a book to be released this spring about his experiences with religion and the US Govt. and the Ruby Ridge disaster where his wife and son were both killed by US Govt. agents. His account of the tragedy is much different than that originally portrayed by the media. According to him the US Govt. was trying every way possible to recruit him as an undercover informant and as he resisted this they broke the law in attempts to strong arm him into cooperation. Randy hopes his book will cause people to think and examine their beliefs for accuracy. He says at age 33 , "everything changed when I learned Christmas was a pagan holiday. I learned things I thought were sacred were just the creation of men. That's when I started questioning all sorts of things...I had allowed other people to think for me." *Missoulian* Jan. 11, 1998.

Art - "Artistic parents raise happy kids! Parents in creative professions create happy homes. That's the finding from a survey of college students by psychologist Barbara Kerr of Arizona State University in Tempe. Students who said they came from happy families tended to have parents in creative occupations - artists, writers, designers, musicians, photographers and craftspersons. When asked whether their parents supported their ideas, the students replies were "so strong," Kerr says, "that we had to divide the responses into 'yes' and 'yes plus.'" *New Age Journal* Jan. / Feb. 1998. It may be that artistic people are also more tolerant of other people living their own ideas, and that might include their children living their own ideas too. Common sense and experience tells me that makes for more happy families.

Science & Technology - "According to John V. Milewski PhD, there are two forms of light. The first is our standard electromagnetic light that is formed from electrons (electric monopoles), dropped to a lower orbit, giving off energy in the form of electromagnetic radiation, which travels at the speed of light. The second form of light is called super light and is magnetoelectric radiation that is generated in the large black holes through the movement of magnetic monopoles as they change energy states. Thus, black holes radiate massive amounts of energy in the form of super light which escapes the black holes since the velocity of super light is C , or 10 billion times faster than light. The wavelength is also about ten billion times shorter than light and their energy is 10 billion times greater." *The Reaper* 11/12/97. This ties in with Millennium Twain's assertions about a superluminal velocity of light as in the letters to the editor this issue and in last issue's article on his Metric Relativity Theory. - United Solar Systems has solar shingles nearly indistinguishable from ordinary asphalt shingles that are made from stainless steel coated with a thin film of amorphous silicon photovoltaic cells. They are nailed on with common roofing tools to conventional roof decking, then electricians wire them together from the inside. They are flexible and lightweight. Their cost - about \$15 per watt which is comparable to regular solar panels. Four hundred square meters of solar shingles, an area about one third the size of an ordinary roof can power an average household when exposed to six hours of sunlight a day. United solar systems 1-800-843-3892. *New Age Journal* Jan/Feb 1998.

Business/Commerce - "Americans are going bankrupt in record numbers at a time when the economy

has experienced one of its longest ever periods of uninterrupted growth. According to figures published Tuesday by the Visa USA credit card company, the number of Americans declaring themselves bankrupt shot up by 19% to 1.34 million last year - more than at any time in the nation's history, including the Great Depression. *Missoulian* Jan. 11th, 1998.

Agriculture - Soybeans have rose from almost nothing 40 years ago to being the third ranked crop at 24% of acreage after wheat and corn at 28% each. In the last 4 years soybean production is up 46% to 74.5 million metric tons this years USDA forecast. Soy products to replace meats have been shown to decrease cancer, heart trouble, and kidney disease risks. Soy also does a double play in that soy is used to feed animals raised for meat in developing countries that wish to increase meat production. *Missoulian* Jan. 11th, 1998.

Education - High school students who take algebra, geometry and other rigorous math courses are much more likely to be successful at college or in the work force says a US Education Dept. report. Students with a grasp of higher level math achieve regardless of family income or public or private schooling, says Education Sec. Richard Riley. The proportion of students who take Algebra 1 and geometry who made it to college; 80% of all students; 71% of low income; 94% of high income; 84% of middle income. Tamara Henry, *USA TODAY* 10/20/97. Blend this with the study showing that artistic parents create happier children and the following quote by Albert Edward Wiggam, "Intelligence appears to be a thing that enables a man to get along without education. Education enables a man to get along without the use of his intelligence." Both from *The Reaper* 11/12/97. The blend for me is that intelligence is using both the intuitive, artistic, feminine side of our nature with the intellectual (analytical/synthetical) masculine side of our nature at the same time. This blend releases clear vision, intuitive grasp and ability to express universal principles to immediately solve the unending challenges/opportunities of life. Exposure to and assimilation of the works of those who have accomplished this blend such as the Russell works can help us model this behavior ourselves.

Miscellaneous - "There are five actions that help demonstrate love: 1) Touch, 2) Talk/Communication, 3) Deeds, 4) Looking after the other person's economic well being by doing loving things that can be purchased with money, 5) Giving the gift of time to others. All five are ways of expressing love. *The Reaper* 11/12/97.

Newsletters/Periodicals

NEW SCIENCE/TECHNOLOGY/FREE ENERGY

Electric Spacecraft Journal. Published quarterly, annual subscription rate \$24, Canada/Mexico \$29, other countries \$39. ESJ publishes research articles on new science, inventions and network notes from the ESJ network of individuals sharing ideas about these topics. Devoted especially to discovering the means/mechanisms for "electric" spacecraft and all that such understanding would mean for our civilization. I have known the editor Charles A. Yost the last few years and he spoke at our 1995 symposium. I find Charles' ESJ to be interesting and informative, and although most articles are very technical there are aspects of the journal that the average reader should find comprehensible and of interest. Charles A. Yost editor. ESJ, 73 Sunlight Drive, Leicester, North Carolina 28748. Phone 704-683-0313 Fax 683-3511.

The Space Energy Journal Published Quarterly. \$35 U.S., \$40 Canada & Mexico, \$50 elsewhere. Jim Kettner and Don Kelly editors. This journal publishes the positive and the negative results of testings of free energy machines and other new science experiments. The discussion of new science ideas is technical and yet also very down to earth so that the average reader should follow most of it. I have met Don Kelly through my association with the International. Assoc. for New Science/ International. Symposiums for New Energy and he is familiar with the Russell work too. Space Energy Association, P.O. Box 11422, Clearwater FL 34616. Phone/ Fax 813-461-7119.

New Energy News is the newsletter from the Institute for New Energy. It is a collection of reports on inventions, ideas and of publications relating to alternate and free energy. Monthly free to members with member fee of \$35 and \$60/yr. to corporations, libraries and universities. Hal Fox Editor, P.O. Box 58639, Salt Lake City, UT 84158-8639. Phone 801-583-6232 Fax 583-2963.

The *Planetary Association for Clean Energy* newsletter publishes articles to facilitate the development of a wide range of clean energy technologies including free energy technologies. Usually quarterly \$35/yr. Canada, \$40 USA, \$45 elsewhere. Andrew Michrowski, editor, Planetary Assoc. for Clean Energy, Inc. 100 Bronson Ave. Suite 1001, Ottawa, Ontario, Canada K1R 6G8. Phone 613-236-6265 Fax 235-5876.

INVESTMENT/INTL. POLITICS/ ETC.

The Reaper. 36 issues per publishing year. I year- \$195. 10 issue trial - \$60. *The Reaper* is a no holds barred newsletter examining our current global and national economic/political status with an eye towards assisting investors in commodities, currencies, real estate, etc., etc. Publisher R.E. McMaster Jr.

is an acquaintance of mine who I introduced to the Russell's work and I have subscribed to his NL off and on over many years - not because I am an investor (I should be and if I would have followed much of his advice would have made some cash, but I'm too involved in other work), but because I have been fascinated with R.E.'s analysis of our world situation. Called the Indiana Jones of the Christian economists by some he has a 'Christian' point of view but it is not conventional in my estimation. He is aware of new energy and natural health/healing practices and reports on these areas at times. P.O. Box 84901, Phoenix, AZ 85071. Phone 800-528-0559.

EARTH CHANGES/ESOTERIC

The Earth Changes Report 12 issues/yr. \$36; Canada, Mexico, Alaska & Hawaii \$46/yr.; \$56/yr. elsewhere. Published by futurist/psychic predictor Gordon Michael Scallion gives Gordon's psychic predictions and a review of his hits and misses as well as articles in the new age spiritual genre and a report of earthquake, climate changes, etc. worldwide. I have watched Gordon Michael's predictions for the last several years and while he is not 100% on target he has been close enough on enough times to be much more than just coincidence. Published in the spirit of better to be prepared for what does or does not happen than to be unprepared for what does happen, the ECR is a good monthly review of earth changes as they happen and of what might happen beyond most folks wildest dreams - both pro and con. Matrix Institute, P.O. Box 336, Chesterfield, NH 03443. Phone 1-800-628-7493.

ESOTERIC/NEW SCIENCE

New Science News

published by the International Association for New Science (IANS) addresses metaphysical and esoteric perspectives on pro-social topics such as sociopolitical, new age, and new science concepts. I have spoken at several of their conferences on the Russell's work as well as alternative healing topics. Quarterly, \$35 membership. Bear Jack Gebhardt, editor, IANS, 1304 South College Ave., Ft. Collins, CO 80524

KEELYNET NEWSLETTER/INFO EXCHANGE

P.O. Box 870716, Mesquite, Texas 75187

Subscription price unknown - Published Quarterly - Info on new energy science and health information exchanges. The publisher is Jerry Decker a long time Russell student, Keely student and investigator into all kinds of unusual phenomena.

RATBAG ANTIPHYSIC NEWSLETTER

Millennium Twain has moved to New Zealand and is no longer publishing this newsletter. For information about his current activities see the letters to the editor section.

Journal Of New Energy published by the Fusion Information Center, P.O. Box 58639, Salt Lake City, Utah 84158-0638. A quarterly Journal subscription: \$150. Single Issues: \$45. This is a journal of the Institute of New Energy. It has published the papers presented at the first and second low energy nuclear reactions conferences held at College Station, Texas at Texas A&M University. This journal is top quality work presented by some of the leading thinkers and researchers in the field of new energy.

Economics In Action published by The Institute Of Economics Box 257, Ridgeway, CO 81432. A bi-monthly newsletter. A years subscription is \$35. It details the efforts of the Institute to transform our planet through business based on sound ecological principles. Articles on new energy, education, and any area of technology and commerce that can positively effect our lives may be published.

ADVERTISEMENT

The Fusion Information Center is pleased to announce its appointment as an authorized distributor for the **Cincinnati Group's Low-Energy Nuclear Transmutation Kit**.

**BECOME ONE OF THE WORLD'S
FIRST TRANSMUTATION EXPERTS**

Being heralded as "The scientific discovery that will change the world!" the production and marketing of the **RADIOACTIVE REMEDIATION KIT – LENT-1** ushers in the scientific paradigm shift that has been forecast by many new-energy experts. The purchase and use of this kit is the first important step for your company to become a leader in transmutation energy in the New-Energy Age.

Here is what you get with the **LENT-1 KIT**:

1. Specially machined, Closed-cell, Zirconium **Electrolyte Chamber**
2. The **Trenergy Power Supply**.
3. Complete Instructional Manual.
4. Access to experienced transmutation personnel for technical assistance.
5. Full year's subscription to *Infinite Energy*, *New Energy News*, and *Journal of New Energy*. These publications will be the leading source of additional information about the latest new developments in this exciting science.
6. A money-back guarantee if this equipment cannot transmute selected elements under proper operation.

You can attain a new profession for less than the cost of a used car or a week's special technical seminar. Your company can become a new-energy leader. Each person and each company has three choices for this new technology:

Fight it. Ignore it. Lead it.

LEADERS: Please phone, write, or fax for price and delivery information.

INVESTORS: Opportunities exist for qualified investors. Phone for offering memorandum.

For price and delivery information about the **LENT - 1 KIT** call fax or write to **TRANSMUTATION KIT C/O Russell Science Research team, Dr. Timothy A Binder Box 520 Waynesboro VA 22980 voice 540-942-5161 Fax 540-942 -8705** International customers may also request information by email: usp@rica.net

In The Wave Lies The Secret Of Creation

by Dr. Timothy A Binder

This soft cover treatise on the Russell Cosmogony with 44 color charts, 10 black & white charts and 31 diagrams is now available. The book presents a Universal Systems Model that is applied to language in order to facilitate greater comprehension of the Russell Cosmogony. A comparison of Russellian Science and the Science of his time is given as is a description of the chief elements of the Cosmogony including: the eighteen dimensions, formula of the locked potentials, wave mechanics, the cube and the sphere, periodic charts, thermodynamic laws, and Newton's first and third laws versus the Russell Cosmogony to give a firm basis to understand Walter Russell's scientific paintings and charts.

An analysis of the paintings and charts comprises the second half of the book. Most of the paintings included in this volume have never before been published. The cover of this issue of *Fulcrum* has one of these paintings as its front cover piece.

Cost is \$35 plus \$3 postage within the USA. Phone 1-800- 882- LOVE to order your copy today!

Subscription and Back Issues Information

An annual subscription to *Fulcrum* published 3 times a year is \$25 postpaid in the USA \$30 Canada and \$35 elsewhere. Back issues are available at \$7 an issue.

READERS,

We will send a sample copy of any issue of the FULCRUM to interested individuals who are not subscribers; simply mail us the name, address and number of the issue you would like us to share. Now is the time for God's science of creation to move into human consciousness. Thanks for your support!

Name: _____

Street: _____

City, State, Zip: _____

Phone: _____

Enclosed for FULCRUM:

_____ Back Issues @ \$7 each - Vol. #(s) _____ • _____ 1 year (3 issues) \$25

Send to: FULCRUM, Science Journal
University of Science & Philosophy
P.O. Box 520, Wyandeboro, VA 22980
Phone #: (540) 942-5161 Fax: (540) 942-8705 Orders: (800) 882-LOVE